



iAM-SUM8

iAM-SUM16

iAM-SUM32

Multi-Channel Audio Monitor/Mixers

User Guide

Part Number 821836, Revision A



This publication is protected by federal copyright law. No part of this publication may be copied or distributed, stored in a retrieval system, or translated into any human or computer language in any form or by any means electronic, mechanical, manual, magnetic, or otherwise, or disclosed to third parties without the express written permission of Wohler Technologies.

Reproduction

Licensed users and authorized distributors of Wohler Technologies, Inc. products may copy this document for use with Wohler Technologies., Inc. products provided that the copyright notice above is included in all reproductions.

Customer Support

Wohler Technologies, Inc.
1280 San Luis Obispo Ave
Hayward, CA, 94544
Phone: 510-870-0810
Web: www.wohler.com
Sales: sales@wohler.com
Support: support@wohler.com

Disclaimers

Even though Wohler Technologies, Inc. has tested its equipment and software, and reviewed the documentation, Wohler Technologies, Inc. makes no warranty or representation, either express or implied, with respect to software, documentation, their quality, performance, merchantability, or fitness for a particular purpose.

In no event will Wohler Technologies, Inc. be liable for direct, indirect, special, incidental, or consequential damages resulting from any defect in the hardware, software, or its documentation, even if advised of the possibility of such damages.

Some states do not allow the exclusion or limitation for incidental or consequential damages, so the above exclusion or limitation may not apply to you.

PDF

All text strings appearing in [this shade of blue](#) are hyperlinks.

Other Technologies and Products

Google Chrome is a registered trademark of Alphabet Inc.
Microsoft Windows and Internet Explorer are registered trademarks of Microsoft Corporation.
Dante and Brooklyn are registered trademarks of Audinate Pty Ltd.
Ravenna is a registered trademark of ALC NetworX GmbH.
ZMAN and Aneman are registered trademarks of Merging Technologies.

All product names, logos, and brands are property of their respective owners. All company, product and service names used in this document are for identification purposes only. Use of these names, logos, and brands does not imply endorsement.

Last Update

March 29, 2023

TABLE OF CONTENTS

Table of Contents

User Guide	1
TABLE OF CONTENTS	3
Table of Contents	3
CHAPTER 1: Installation	7
Introduction	7
Overview	7
Safety	7
Instructions	7
Safety Symbols	8
Mounting	8
Heat Dissipation	8
Sympathetic Vibration	9
Mechanical Bracing	9
Electrical Interference	9
Power	9
Compliance	9
FCC	9
ICES-003	10
CHAPTER 2: Local Operation	11
Operation	11
Startup	11
Front Panel	11
Rear Panel	13
SFP-2022-6 / SFP-2110 Address Setup	18
Channel Meter Screen	19
Operating the Monitor	20
Add or remove Clusters from the Monitor Mix	20
Solo a Cluster	20
Adjust the Trim of a Cluster	21
Selecting the Loudness Cluster	21
Menu / Option Touchscreen	22
Main Menu	23
Loudness Menu	23
Loudness Meter	23
Loudness Settings	26
Source Select	27
Presets	29
All Presets	29
Preset Favorites	31
Unit Settings	32
Speaker Options	32

Unit Configuration	33
Meter Scales	34
Phase Configuration	36
Analog Configuration	37
System Options Menu	38
Network Settings.....	38
System Reboot	40
System Update	41
Factory Reset	42
System Information	43
Passcode Settings	44
Forgotten Passcode	46
CHAPTER 3: Technical Info	47
CHAPTER 4: The iAM-SUM Web GUI.....	52
Web Browser / Control Device.....	52
First Time IP Assignments	52
Peer-to-Peer Connection.....	52
Network Connection.....	53
Network Setup.....	54
Dashboard	55
Audio Meters	59
System Preferences	60
System Audio Clock Reference	60
Loudness Configuration Tab	61
Front Panel Configuration Tab	62
Preset Management	65
Output Routing	69
Destination Outputs	70
Source Inputs	71
Output Options	71
Typical Questions Regarding Output Routing	72
What signal outputs can be controlled using the Output Routing feature? ...	72
How do the outputs behave if I do not purchase OPT-OUTPUT-ROUTING	
license?	72
What is the difference between Global Output Routing and Output Routing in	
Presets?.....	72
How do I route whatever is being monitored to the XLR and AES outputs?..	73
How do I have a downmixed pre-fade output on AES Pair-1 combined with a	
post-fade output on the Analog XLRs?	73
How do I make the XLR outputs follow the Audio Meter screen solos & mutes	
while the AES Pair-1 does not?.....	73
How do I route only specific monitored channels to the Analog XLR outputs?	
.....	74
The optional Global Output Routing feature works great. But what if we don't	
want to create any Presets and want to monitor audio only using Source	
Select? How would I configure different outputs for Source Select choices? .	74
How do I keep the internal speakers muted and have audio only on the	
analog XLR outputs?	75
How do I ensure that the outputs are automatically muted when the	
Headphone jack is inserted?.....	75
What are AoIP-Pair 9 and AoIP Pair 10?	76
How do I ensure that my outputs are pre-faded but follow the solo-mutes on	

the web interface? This will allow us to monitor only the unmuted/solo Audio Meter channels on amplified stereo speakers connected to the Analog XLR's.	76
.....	76
Preset Replication.....	77
Import/Export Presets.....	79
Export Configuration	79
Import Configuration	80
System.....	82
System Information	82
SFP Information	83
Licenses.....	84
Factory Reset	85
Reboot System	86
APPENDIX A: Software Upgrades.....	87
Introduction	87
Download the Software	87
Update Methods	87
Local Update from the Front Panel	88
Updating via the Web GUI using a Flash Drive	90
Updating an <i>iAM-SUM</i> Remotely	92
Updating Multiple Units Remotely	94
APPENDIX B: Dante Network Setup	97
Introduction	97
What is in the <i>iAM-SUM</i> for Dante?	97
Dante™ Device Setup	99
Dante Clock Selection	100
Channel Names.....	100
AES67	101
Device Lock.....	103
Dante Firmware Upgrades	103
Additional Information	104
Dante™ Legal Disclosures.....	104
APPENDIX D: Ravenna (ZMAN) Setup	105
Introduction	105
What is in the <i>iAM-SUM</i> for Ravenna?.....	105
RAVENNA-Compatible Talker/Listener.....	105
AVB Ethernet Features	105
Configuring the AOIP Merging Option Card	106
Getting Started General Settings	107
Getting Started PTP.....	108
Getting Started Session Sources.....	109
Getting Started Session Sinks	110
Getting Started Session Info	111
Getting Started Ins/Outs	112
Getting Started I/O Router	112
Operation:	113
Connecting Remote Source to Local Sink	113

ZMAN Session Sinks	113
ZMAN Session Sources	115
ZMAN Updating	115
APPENDIX E: API Documentation	116
Introduction	116
API: Presets	116

CHAPTER 1: Installation

Introduction

Overview

The iAM-SUM Series is a set of well featured, easy to use and competitively priced IP ready audio monitors /mixers available in 8, 16 or 32 channel configurations. Whether monitoring 8, 16 or 32 channels, the unit can be configured to operate in channel mode and/or pair mode. Standard features include 3G-SDI and a pair of Analog inputs and outputs. Upgrade/license other signal formats and processing options, as and when needed, either initially or after purchase. Refer to the Specifications section of this manual or contact Wohler Sales for more information.

The iAM-SUM is compact and simple to operate, with straightforward controls. It has a very wide format touch screen LCD display providing up to 8, 16, or 32 high resolution level meters, depending upon the model. Any audio channels (or channel pairs) from any audio/video source stream may be monitored.

The iAM-SUM includes two 3G SDI inputs, one switched 3G SDI output, and a pair of analog inputs and outputs. Optional modules will allow decoding of an additional SDI input, MADI, AES3, SMPTE 2110, SMPTE 2022-6, and AES streams. It contains APIs for remote management.

Optional Output routing enables the flexibility to route input signals to various outputs. Optional I/O for AES3 on HD-15 (including selected audio source converted to AES3 out), MADI on BNC (and looped output), and SMPTE 2110 or SMPTE 2022 via SFP is offered. Option cards will allow choice between AoIP, an additional 8 channels of analog inputs and outputs, or 2 additional SFP cages.

Setups are created and configured using local menus and a web browser over a network connection to the integral web server of the iAM-SUM. Up to 64 Presets are accommodated. The web server will also allow you to view the audio meters remotely.

Safety

Instructions

1. Read, keep, and follow all of these instructions; heed all warnings.
2. Do not use this equipment near water.
3. Use only a dry cloth to clean the equipment.
4. Do not block any ventilation openings.
5. Do not install near any heat source such as a radiator, heat register, amplifier, or stove.
6. Do not attempt to plug the unit into a two-blade outlet (with only two prongs of equal width).

Important:

By design, the supplied AC mains power cord will only plug into a three-prong grounded outlet for your safety. If the plug does not fit into the outlet, contact an electrician to replace the obsolete outlet.

7. Protect the power cord from being walked on or pinched, particularly at plug connection on the equipment and at the socket.
8. Use only the attachments/accessories specified by the manufacturer.
9. Unplug the equipment during lightning storms or when unused for long periods of time.
10. Refer all servicing to qualified service personnel. Servicing will be required under all of the following conditions:
 - a. The equipment has been damaged in any way, such as when the power-supply cord or plug is damaged.
 - b. Liquid had been spilled or objects have fallen onto the equipment.
 - c. The equipment has been exposed to rain or moisture.
 - d. The equipment does not operate normally.
 - e. The equipment has been dropped.

Safety Symbols

WARNING:

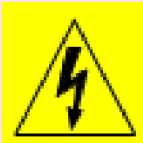

The symbol to the left warns of electric shock hazard inside the unit. Disconnect the power cord before removing access panels when installing upgrades. Only qualified service personnel are to operate the equipment with covers removed, and are to exercise caution to avoid personal injury.

Mounting

The unit is designed for a standard 19" rack. Install it at ear/eye level for best high frequency response and visual observation of the display screens. Please adhere to the following clearances:

Table 1-1: Clearance Recommendations

Clearance	Surface
24"	Front
3"	Rear
2"	Sides
1.75"	Top and Bottom (if either radiates heat)
0"	Top and Bottom (if no heat)

Heat Dissipation

The ambient temperature inside the mounting enclosure should not exceed 40° Celsius (104° Fahrenheit). Adjacent devices can be rack mounted (or stacked) in

proximity to the unit if this temperature is not exceeded. Otherwise, allow a 1RU (1.75"/44.45mm) space above and below the unit for air circulation.

Important

Heat generated by the class D power amplifiers, power supplies, and other components is vented by slots in the sides and back of the unit. Therefore, as a safety precaution, you must allow proper ventilation on these surfaces.

Sympathetic Vibration

Sympathetic vibration from other equipment (cables, etc.) in the rack may be serious enough to interfere with the unit's sound quality. If you experience sympathetic vibrations, use thin card stock, felt, foam, or weather-stripping between the vibrating surfaces. Tie loose cables securely with cable ties.

Mechanical Bracing

The 1RU chassis is securely attached to the front panel. In addition, the chassis has mounting tabs through which you attach it to the rack rail. This feature will reduce or eliminate rear bracing requirements in many mobile/portable applications. The weight of internal components is distributed fairly evenly around the unit.

Electrical Interference

Be careful to avoid mismatched cable types and other similar causes of undesired reflections in digital signal systems. If severe enough, such reflections can result in corruption of the digital data stream. As with any audio equipment, maximum immunity from electrical interference requires the use of shielded cable; however, satisfactory results can sometimes be obtained without it. The internal circuitry ground is connected to the chassis.

Power

The unit connects to an AC mains power source (100 to 240 VAC, 65W, 50/60Hz) using an IEC power cord.

When the mains plug or appliance coupler is used as the disconnect device, the disconnect device should remain operable.

Compliance

FCC

This equipment has been tested and found to comply with the limits for a Class A digital device, pursuant to part 15 of the FCC Rules. These limits are designed to provide reasonable protection against harmful interference when the equipment is operated in a commercial environment. This equipment generates, uses, and can radiate radio frequency energy and, if not installed and used in accordance with the instruction manual, may cause harmful interference to radio communications. Operation of this equipment in a residential area is likely to cause harmful

interference, in which case users will be required to correct the interference at their own expense.

ICES-003

This Class A digital apparatus complies with Canadian ICES-003.

Cet appareil numérique de la classe A est conforme à la norme NMB-003 du Canada.

CHAPTER 2: Local Operation

Operation

The *iAM-SUM* can be operated easily and simply from controls on its front panel, as described in this chapter. It may be accessed remotely in two ways, via the Wohler Web GUI for administrative purposes or by third party equipment via Application Programming Interface (API) commands. The Wohler Web GUI is described in Chapter 4 of this manual. The API commands are described in Appendix E of this manual.

Startup

The *iAM-SUM* will begin its startup process when it is connected to power. There is no power switch. It is normal for the product to require about 45 seconds to start up and be ready to use.

When the *iAM-SUM* completes its startup, the **Status** indicator will turn green. Depending upon optional settings, all channel pairs will either be in the muted condition or set in a predetermined way. You may then use the **Source** and **Channel** controls to enable only the program channels you want to hear.

Front Panel

The front panel is shown in Figure 2-1.

Figure 2-1: *iAM-SUM* Front Panel

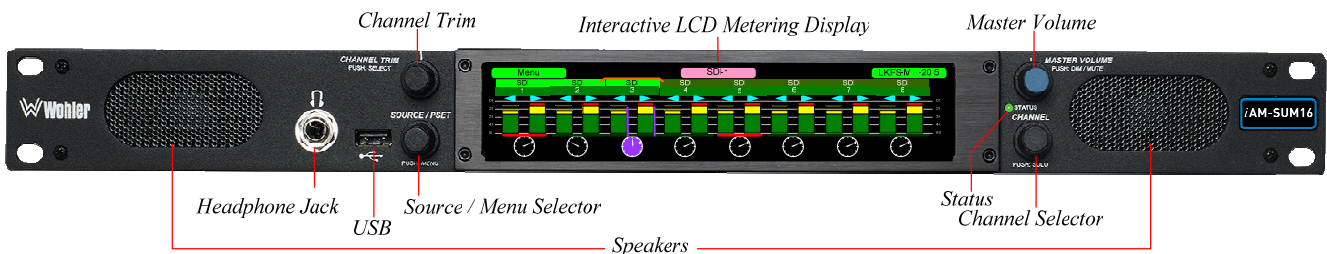

1. **Interactive LCD Metering Display:** A widescreen LCD touch screen allows monitoring of bar graph meters of up to 8, 16, or 32 channels, depending upon the model, as well as selecting which channels to monitor audibly.
2. **Speakers:** Local near field audio monitoring is achieved through the use of Class D amplifiers. There are two (left/right) speakers.
3. **Headphone Jack:** A 1/4" jack for an optional headphone is provided on the front panel. Speaker audio can be optioned to either mute or not mute when headphones are plugged in. This is set in the **Speaker Options** menu. If the

speaker audio is set to mute with headphone insertion, and a headphone is plugged into the Headphone Jack, the following icon will appear at the center top of the

display: 

4. **Master Volume:** This controls the speakers, the headphone and the analog outputs. As the **Master Volume** control is turned, a graphic appears on the upper part of the screen as follows: 

Pressing the **Master Volume** control dims the audio and a second press mutes the audio. When the audio is muted, a speaker muted icon appears at the center top

the display:  This icon also displays whenever the **Volume** control is turned all the way counterclockwise. Rotating the **Master Volume** immediately removes the dim or mute.

5. **Channel Trim:** This control lets you adjust the volume level of individual channels or pairs in the mix.
6. **Source/Preset/Menu Selector:** Turning this control right or left selects between the available licensed input sources. Pressing the **Source/Preset** control for 2 seconds proceeds to the **Main Menu**. Alternatively, rotating the **Source/Preset** control can be set to No Operation, so that rotating it will have no effect at all. Refer to the **Source Knob Select** setting in the **Unit Config** menu.
7. **Channel Selector:** This is used to select individual channels or channel pairs for the purposes of soloing, adding to the monitored mix or removing from the mix, or trimming their volume level.
8. **USB:** This USB 2.0 Type A connector allows use of a flash drive (not supplied) to perform software updates.
9. **Status:** This indicator lights green when the system is powered and ready for use. A solid or blinking yellow color indicates that the product is starting up. A red color indicates that a system update is taking place.

Rear Panel

The rear panel is shown in Figure 2-2.

Figure 2-2: *iAM-SUM* Rear Panel & Option Cards

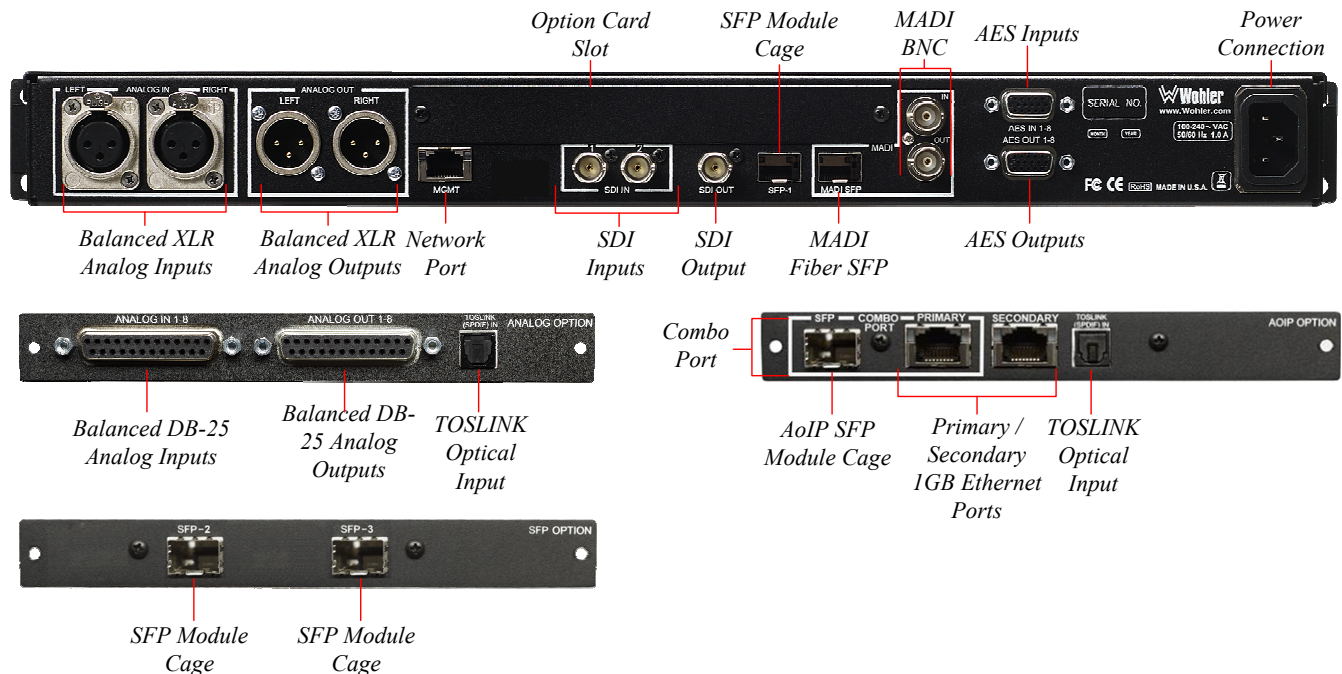

Power Connection: The *iAM-SUM* receives power from an AC inlet, which is a standard IEC receptacle for 100 to 240 VAC $\pm 10\%$, 50/60 Hz power connection. Four regional AC power cords, supplied according to shipping region, are available.

Important:

By design, the supplied AC mains power cord will only plug into a three-prong grounded outlet for your safety. If the plug does not fit into the outlet, contact an electrician to replace the obsolete outlet.

1. **SDI Inputs:** These two BNC connectors accept the two 3G/HD/SD-SDI input signals containing audio to be monitored. This is a standard feature.
2. **SDI Output:** This BNC connector outputs the selected 3G/HD/SD-SDI or SFP module input signal.
3. **Network Port:** This Ethernet port can connect to either a LAN or to a PC to let you perform administrative tasks remotely. The Wohler Web GUI is described in Chapter 4 of this manual. Third party equipment, connecting to the *iAM-SUM* via a LAN plugged into this port and using an API commands, can view and change product options, as well. This API is described in Appendix E of this manual.
4. **MADI BNC:** (optional) The COAX input accepts an AES10 64-channel signal at 48 kHz sample rate. An optional license key must be purchased to

enable this function. The COAX output is relocked from the MADi source. When power to the *iAM-SUM* is not present, the COAX input and output are automatically connected together to allow the MADi signal to pass through. A software license must be installed for this input to function. Refer to the **System Setup** section in Chapter 4 to install software licenses.

5. **MADi Fiber SFP:** (optional) This input module accepts an optical AES10 64-channel MADi input signal at 48 kHz sample rate. An optional license key must be purchased to enable this function. A software license must be installed for SFP ports to function. Refer to the **System Setup** section in Chapter 4 to install software licenses.
6. **AES Inputs:** (optional) This HD-15F connector accepts 4 AES3id digital audio pairs (8 channels) at a 48 kHz sample rate. Refer to Figure 2-3 for the pinout of this connector. The easiest way to interface with this connector is to use an HD-15 to VGA adaptor cable. Channels are selected as AES 1-8. A software license must be installed for these inputs to function. Refer to the **System Setup** section in Chapter 4 to install software licenses.

Figure 2-3: AES HD-15F Connector Pinout

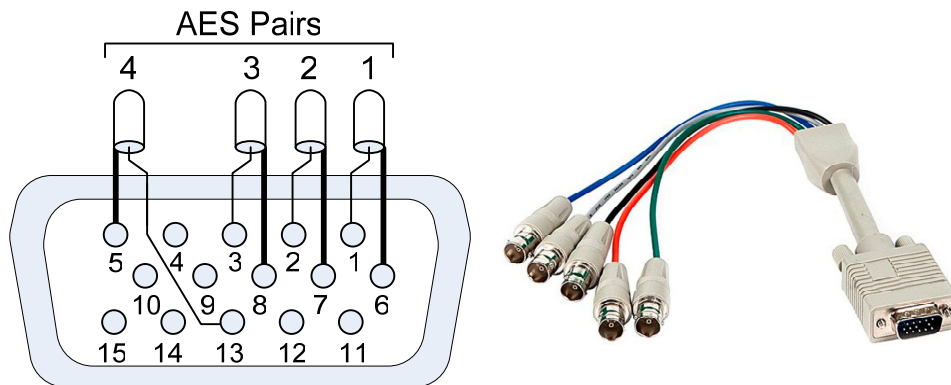

7. **AES Outputs:** This HD-15F connector provides 4 AES3id digital audio pairs (8 channels) at a 48 kHz sample rate from selected monitored sources. Refer to Figure 2-3 for the pinout of this connector. The easiest way to interface with this connector is to use an HD-15 to VGA adaptor cable. These outputs are not controlled by the **Volume** and **Balance** controls. Monitored channels 1 and 2 are sent from AES-1, channels 3 and 4 are sent from AES-2, channels 5 and 6 are sent from AES-3, and channels 7 and 8 are sent from AES-4.
8. **SFP Module Cage:** An SFP cage is provided to accept one optional SFP module compatible with SDI coaxial or optical signals. The SFP modules are hot swappable for convenience. An optional license key must be purchased to enable each module. A software license must be installed for the SFP port to function. Refer to the **System Setup** section in Chapter 4 to install software licenses. The following SFP modules are offered:

- a. **3G/HD/SD-SDI Single Video Receiver with Active Loopback:** This uses HD-BNC connectors.
 - b. **3G/HD/SD-SDI Video SFP with Optical Input:** This uses LC fiber connectors. It is a Single-Mode Receiver, Medium Haul, Non-MSA, and no output.
 - c. **SMTPE 2022-6 Receiver:** This uses Multi-Mode 850 NM, LC fiber connectors. It allows the *iAM-SUM* to monitor SDI audio transmitted in real time over Ethernet. You must use the MN-Set configuration software to set up this option. It is available from Wohler Technologies Technical Service.
 - d. **SMTPE 2110 Receiver:** This uses Multi-Mode 850 NM, LC fiber connectors. It allows the *iAM-SUM* to monitor SDI audio transmitted in real time over Ethernet. You must use the MN-Set configuration software to set up this option. It is available from Wohler Technologies Technical Service.
 - e. **SMTPE 2110 or 2022-6 Receiver:** This uses Multi-Mode 850 NM, LC fiber connectors. It allows the *iAM-SUM* to monitor SDI audio transmitted in real time over Ethernet. You must use the MN-Set configuration software to set up this option. It is available from Wohler Technologies Technical Service.
9. **Analog Inputs:** These female XLR connectors provide two balanced analog inputs: Left and Right. The **Analog Inputs** are standard on the *iAM-SUM*. Refer to Figure 2-4 for the pinout of this connector.

Figure 2-4: Analog XLR-F Output Connections

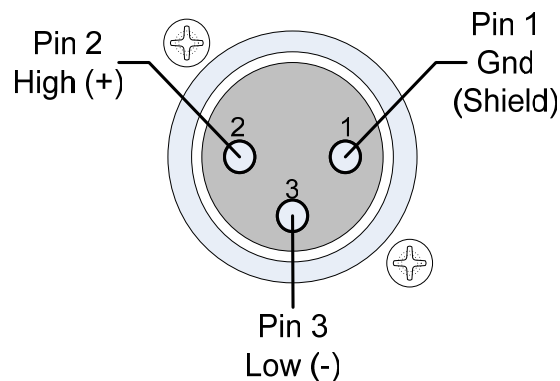

10. **Analog Outputs:** These male XLR connectors provide two balanced analog outputs: Left and Right. The source of these signals is the mix of audio as monitored by the internal speakers and is adjusted by the **Volume** and **Balance** controls. The **Analog Outputs** are standard on the *iAM-SUM*. Refer to Figure 2-5 for the pinout of this connector.

Figure 2-5: Analog XLR-M Output Connections

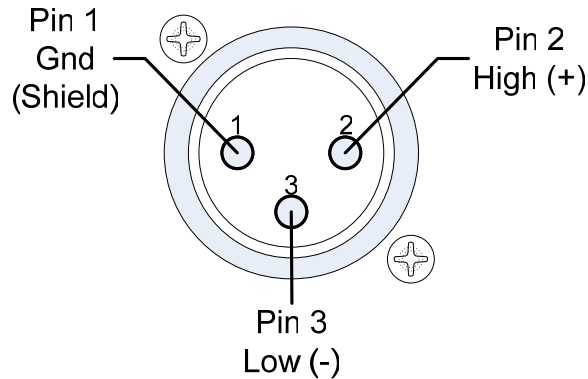

11. **Option Card Slot:** This metal plate can be removed to reveal a location in which future optional modules can be installed.
12. **TOSLINK Optical Input** (optional): This connector is located on the panel of the optional OPT-iVAM ANALOG Option card, as well as on the panel of the AoIP Option card. It provides an optical stereo pair input.
13. **Balanced Analog DB-25 Outputs** (optional): This DB-25 female connector outputs 8 channels of +10dBu broadcast level balanced audio. This connector is located on the panel of the optional OPT-iVAM ANALOG Option card. The source of these signals is the monitored audio channels as shown on meters 1 - 8. Tascam cables may be used, and can be purchased by contacting Wohler Sales. Refer to Figure 2-6 for the pinout of this connector.

Note: PCM channels marked as data channels (such as those containing encoded Dolby streams) are automatically muted from being sent out to the external amplifier and speakers.

Note: When these outputs are used to connect to an external amplifier and speakers, the external amplifier should be muted whenever the *iAM-SUM* is being powered up or powered down.

14. **Balanced Analog DB-25 Inputs** (optional): This DB-25 female connector inputs 8 channels of up to +10dBu broadcast level balanced audio. This connector is located on the panel of the optional OPT-iVAM ANALOG Option card. These signals are monitored on meters 1 - 8 by default. Tascam cables may be used, and can be purchased by contacting Wohler Sales. Refer to Figure 2-6 for the pinout of this connector.

Figure 2-6: Analog DB-25F Input and Output Connections

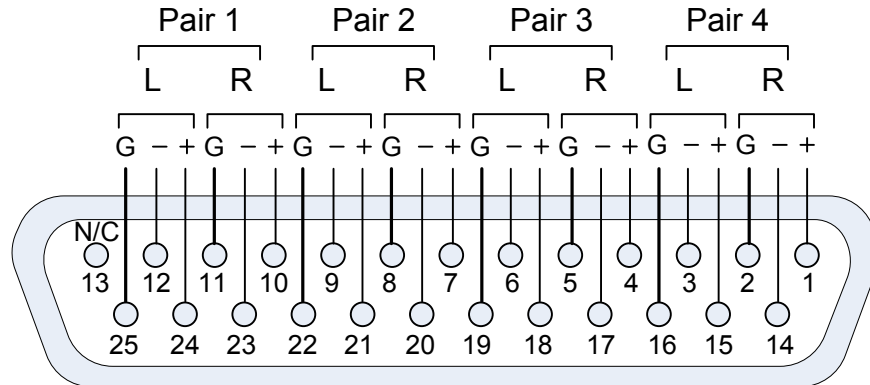

15. **AoIP SFP Module Cage** (optional): This provides a location in which to insert the AoIP Module supplied with the OPT-DANTE (iVAM) and OPT RAVENNA 64 (iVAM) options.
16. **Primary / Secondary 1GB ENET** (optional): Primary and Secondary Gigabit Ethernet interfaces are provided with the AoIP option module.
17. **Combo Port** (optional): An optional 1GB Fiber Ethernet SFP module and the Primary RJ-45 Ethernet port on the option card operate as a combo port, that is, they provide two different physical layers, optical fiber or electrical, but share the same Ethernet characteristics. However, the two different ports cannot be used simultaneously. You must choose to connect either one or the other.

SFP-2022-6 / SFP-2110 Address Setup

While the optional SFP-2022-6 and SFP-2110 modules monitor program audio created from distinctly different technologies, both are connected to the network in the same way and have the same requirements for addressing. Figure 2-7 illustrates the network connections they need.

Figure 2-7: SFP-2022-6 and SFP2110 Network Diagram

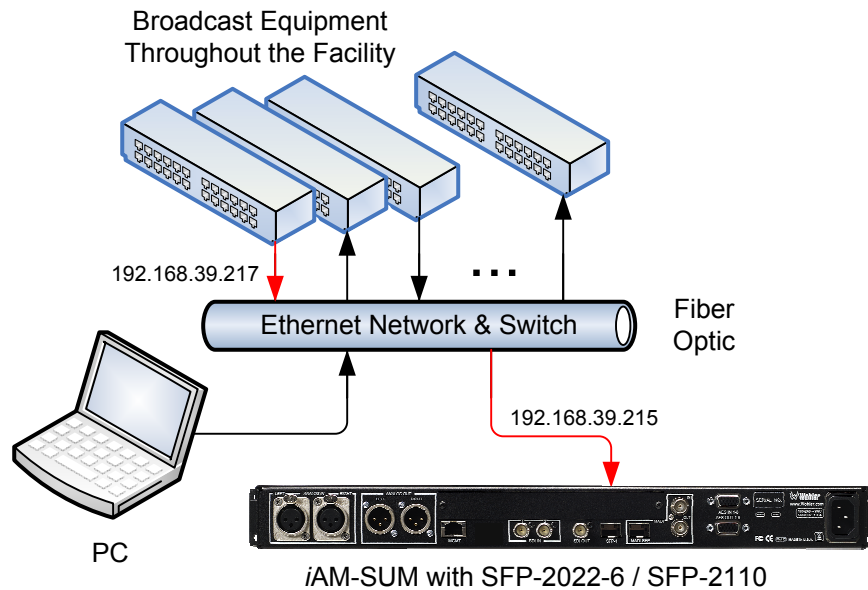

The optional SFP-2022-6 or SFP-2110 module furnished by Wohler Technologies is manufactured by Embrionix and comes from the factory with a default IP address. To integrate it into your digital network, you need to set its address to the source to be monitored. You must use the MN-Set configuration software to set up this option. It is available from Wohler Technologies Technical Service. The procedure to accomplish this is described in the **SFP-2022-6 / SFP-2110 Setup Guide** (part number 821822), which is available at <https://wohler.com/downloads/>.

Channel Meter Screen

Audio meters, as well as other indicators are displayed on the wide touchscreen LCD display in Clusters which can be set up as single channels or stereo pairs, as shown in Figure 2-8.

Figure 2-8: Audio Level Meter Screen

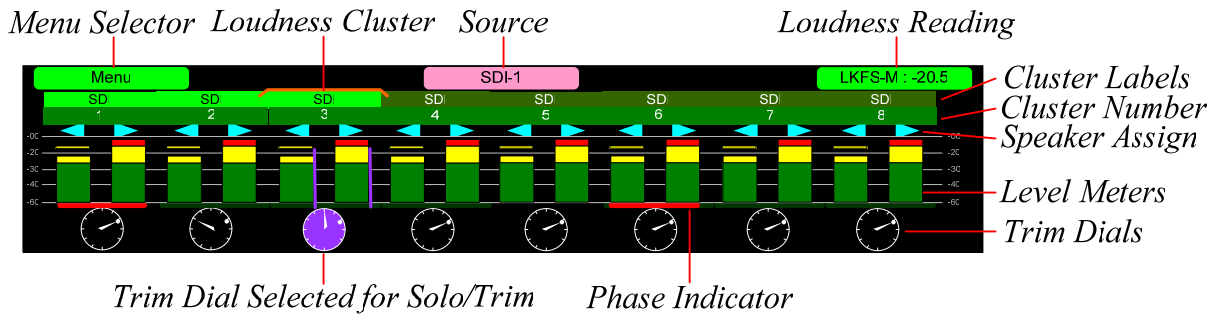

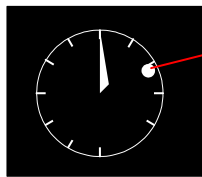
1. **Cluster Labels:** The name or input source of each Cluster is shown. If this designation is dark, the Cluster is not included in the mix. However, if the block containing the name is bright green, then the Cluster is part of the mix. The text of the Cluster Label may be set using the Web GUI. Refer to Chapter 4.
2. **Cluster Number:** Above the level meters are the Cluster Numbers. They indicate the arbitrary sequential numbers of each Cluster in the selected source. They may be set using the Web GUI. Refer to Chapter 4.
3. **Speaker Assignment:** The destination of each channel is shown:
 - ◀ Indicates the channel will be monitored from the left speaker.
 - ▶ Indicates the channel will be monitored from the right speaker.
 - Indicates the channel will be monitored from both speakers.
4. **Level Meters:** A Level Meter is shown for each channel.
5. **Trim Dials:** At the bottom of each channel pair is the round **Trim Dial** indicator. Its rotational position shows the whether the Cluster has been trimmed and relatively how much: The adjustment range is -60dB to +12dB, and the dot indicates where 0dB is located in the range.
 

0 dB Position
6. **Channel Trim:** The channel gain of a particular Cluster can be changed dynamically. When a Cluster can be adjusted, the **Trim Dial** will highlight in purple:  The rotational position of the indicator within the **Trim Dial** shows the adjustment.

Note: To undo all Cluster trims and reset them to the default value in the

Preset, press and hold the **Channel Trim** knob for 3 seconds.

7. **Loudness Cluster Indicator:** The current selected Cluster which is undergoing Loudness analysis is indicated by an orange bracket.
8. **Loudness Reading:** This indicator displays the Loudness of the selected Cluster. This is also a button which allows you to select which Cluster will receive Loudness analysis.
9. **Phase Indicator:** This indicator will normally be dark green if the two channels are in phase. If the two channels are out of phase, the indicator will light red. Note that the Phase Indicator does not appear for Clusters that only contain a single channel.
10. **Source:** The input source of the displayed channels is displayed.
11. **Menu Selector:** Touch the **Menu** button to cause the **Main Menu** to appear.

Operating the Monitor

The audio mixer terminology of "solo" is used in this manual when referring to muting all but a specific Cluster or channel listening only to that cluster or channel.

Add or remove Clusters from the Monitor Mix

To add a Cluster to the monitor mix, simply touch the channel meters for that Cluster. Touch that Cluster's channel meters again to remove it.

Alternatively, rotate the **Channel** knob so that the white box surrounds that Cluster and then press the **Channel** knob. Press the **Channel** knob again to remove the Cluster.

Solo a Cluster

To solo a Cluster, simply touch and hold the channel meters for that Cluster for 3 seconds. A blue box will surround the cluster and it will be the only Cluster heard. Touch that Cluster's channel meters again to remove the solo and return to monitoring the Clusters the way they were before the solo.

Alternatively, to solo a Cluster, rotate the **Channel** knob until a white box surrounds the meters of the cluster to be soloed. Press the **Channel** knob for 3 seconds. A blue box will then surround the cluster and it will be the only Cluster heard. At this point you may rotate the **Channel** knob to move the blue box to solo other Clusters. Press the **Channel** knob once again to remove the solo and return to monitoring the Clusters the way they were before the solo.

Adjust the Trim of a Cluster

Select the Cluster to be trimmed using one of the above methods. With the **Trim Dial** highlighted, rotate the **Channel Trim** knob. Trim can be adjusted in 1 dB steps from -60 dB to +12 dB. The relative trim level will be indicated on the **Trim Dial**. Changing channel gain affects all the outputs that have "Volume Control" enabled in the Web GUI. Refer to Chapter 4. For stereo Clusters, trim is applied to both channels. To end the adjustment, remove the Solo using one of the above methods.

Note: To undo all Cluster trims and reset them to the default value in the Preset, press and hold the **Channel Trim** knob for 3 seconds.

Selecting the Loudness Cluster

To select a different Cluster to be monitored for Loudness, touch the Loudness Reading button on the display. It will turn from green to orange. Then touch the cluster you would like to begin analyzing for Loudness. The orange Loudness Cluster Indicator will move to that Cluster. After 15 seconds, Loudness Reading button will time out and turn green again.

Menu / Option Touchscreen

You may set most options or view a variety of system information using the self-contained menus. To access the **Main Menu**, touch the **Menu** button which appears on the upper left of the level meter screen or press the **Source/Presets** knob for 2 seconds. To exit the Menus, either touch the **Hide Menu** button or hold the **Source/Presets** knob for 2 seconds. Figure 2-9 is a diagram of the menu arrangement, a tree showing how to reach any menu from the **Main Menu**. Figure 2-10 shows the **Main Menu**.

Figure 2-9: Menu Tree

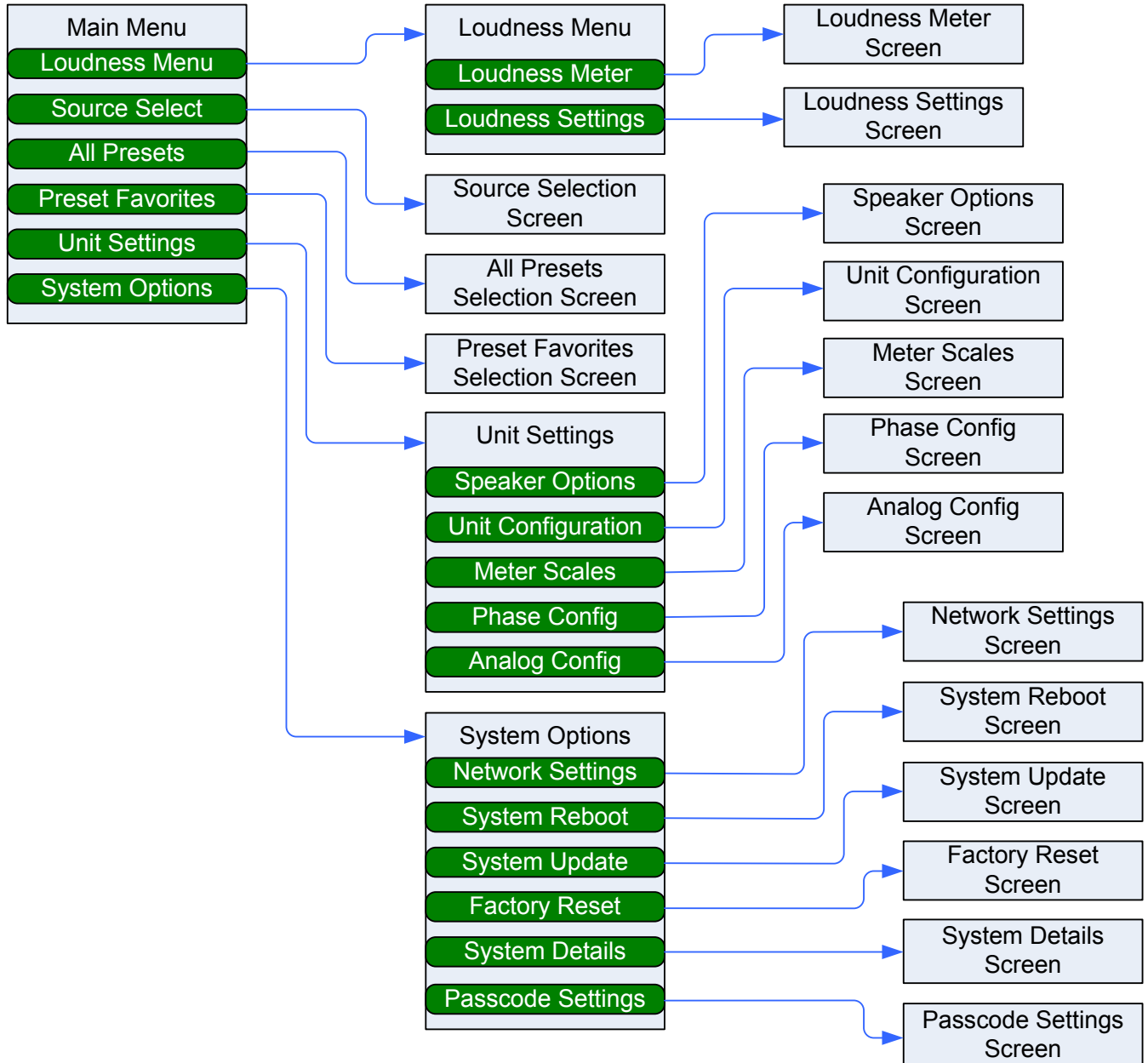

Main Menu

Touch the **Menu** button or press the **Source/Presets** knob to access the **Main Menu**. The **Main Menu** is shown in Figure 2-10.

Figure 2-10: Main Menu

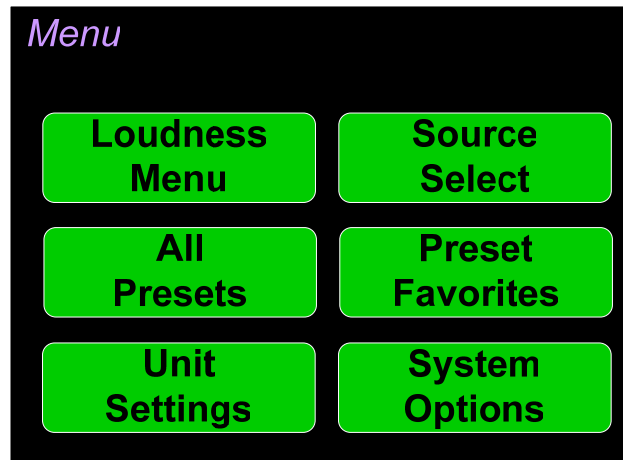

Loudness Menu

Touch the Loudness Menu button to reach the Loudness Menu Screen, which allows you to make a selection of either the Loudness Meter Screen or the Loudness Settings Screen. The Loudness Menu Screen is shown in Figure 2-11.

Figure 2-11: Loudness Menu Screen

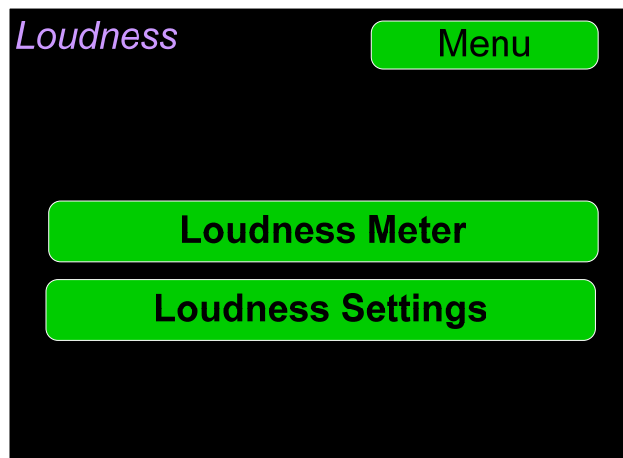

Loudness Meter

Touch the **Loudness Meter** button on the Loudness Menu screen to reach the Loudness Meter Screen. The Loudness Meter Screen is a more detailed view of the Loudness Measurement. It is displayed along with the channel meter screen and is shown in Figure 2-12.

As shown in Figure 2-12, the **Source** knob is located at the lower left of the Loudness Meter Screen. If the **Source Knob Select** setting in the **Unit Config**

menu is set to **Cluster Select**, then rotating the **Source** knob will adjust the channel cluster source of the Loudness measurement. A box on the lower right of the screen shows the selected Loudness Source. Only one channel or channel pair may be selected at a time for measurement.

Figure 2-12: Loudness Meter Screen

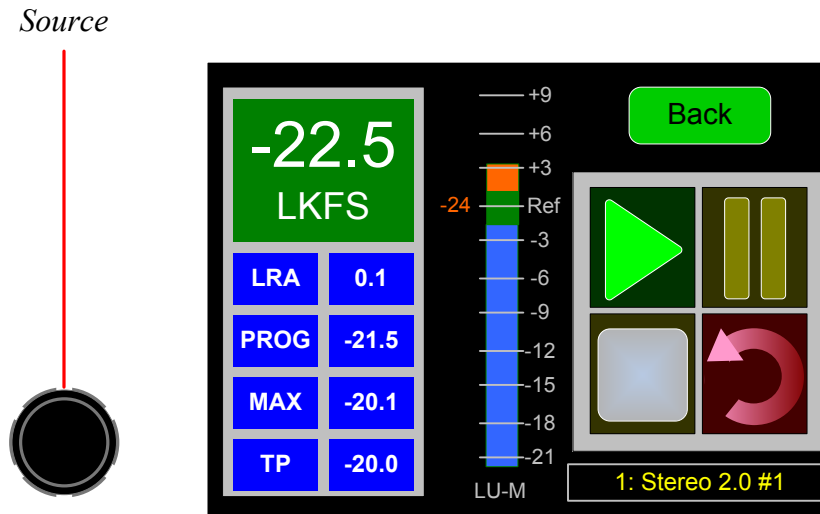

Note: In order to calculate loudness accurately, it is crucial that you correctly set the Channel Function for each channel. Depending upon the designated function of each channel, its signal levels will contribute differently to the Loudness calculation. Refer to the **Configuration | System Preference | Loudness Configuration** tab in the Web GUI.

The following data is available on the **Loudness Meter Screen**:

The Program Loudness (shown as -22.5 LKFS in the figure above) is shown digitally at the upper left of the screen as well as on the meter in the center. At the base of the meter in the center, one of three indications appears:

1. LU-M: This means that the Loudness Window is set to Momentary.
2. LU-S: This means that the Loudness Window is set to Short Term.
3. LU-C: This means that the Loudness Window is set to Custom. The Loudness Window is set in the Loudness tab in the Web GUI.

The LU Meter scale colors have the following meaning:

1. Blue: Loudness is lower than the Reference Level by the Alarm Tolerance.
2. Green: Loudness is within the Alarm Tolerance.
3. Orange: Loudness is greater than the Alarm Tolerance.

Below the digital Loudness meter, in the left column, the following parameters are also displayed:

1. The Loudness RAnge (LRA) is the measure of variation between the calculated loudest and softest passage over the program period (shown as LRA -0.1 above).
2. The Average Loudness is the average of all calculated loudness measurements made over the Program period (shown as PROG - 20.5

above).

3. The Maximum Loudness is the maximum calculated loudness over the program period (shown as MAX -20.1 above).
4. The Maximum True Peak Loudness is the absolute loudest peak waveform over the program period (shown as TP -20.0 above).

Note: Further and more detailed descriptions of all of the above Loudness terms may be found in the ITU-R BS.1770-3 loudness standard.

The controls available on the Loudness Meter Screen are:

1. **Cluster Select:** You may change which Cluster is being measured by simply rotating the **Source** knob to select any other monitored channel cluster. Alternately, touch the green Loudness reading on the Audio Meter screen. It will turn orange and you will be able to touch other clusters and read their Loudness. Changing clusters will reset the loudness readings and start a new calculation on the newly selected cluster.
2. **Start:** When **Manual Mode** is selected in the Loudness Settings screen, from a stopped condition, the **Start** button will reset the gathered loudness data and begin a new reading. From a paused condition, data will not reset as monitoring is resumed.
3. **Pause:** The **Pause** button will temporarily stop or continue gathering loudness data. Data will not be reset using this control. While paused, Loudness will not be measured.
4. **Reset:** The **Reset** button will reset the gathered loudness data. If it is pressed while a loudness measurement is in progress, a new reading will then immediately begin.
5. **Stop:** When **Manual Mode** is selected in the Loudness Settings screen, the **Stop** button will stop gathering loudness data. Data will be held for viewing and not be reset using this control.
6. **Back:** Touch the **Back** button to go to the Loudness Menu.

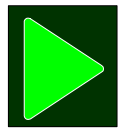

Loudness Settings

Touch the **Loudness Settings** button on the Loudness Menu to display the **Loudness Settings** screen. This screen allows you to change between **Manual** and **Continuous** Monitoring Modes, and also to set the Alarm mode. It also provides a summary of various Loudness settings, as set in the **Configuration | System Preference | Loudness Configuration** tab of the Web GUI. Refer to Figure 2-13.

Figure 2-13: Loudness Settings Screen

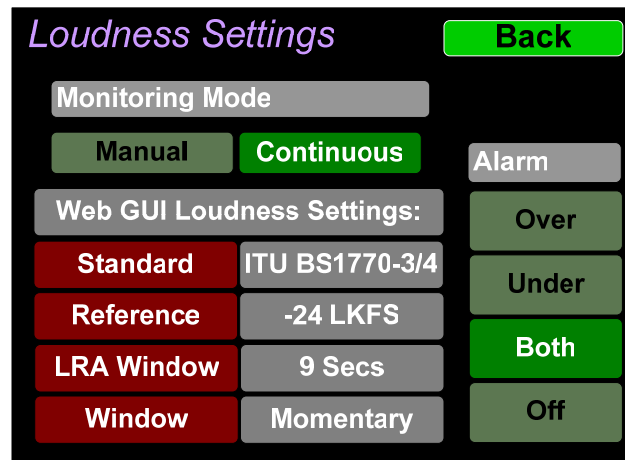

The controls and information available on the Loudness Meter Screen are:

Monitoring Mode:

1. **Manual:** Touch the Manual button to enable Manual Mode. This allows you to measure the loudness of a specific program or segment of a program, such as a commercial. In this mode, the **Start** and **Stop** button on the Loudness Meter screen can be manually used to begin and end a loudness measurement interval. The reading for that interval is then held on the Loudness Meter.
2. **Continuous:** Touch the **Continuous** button to enable Continuous Mode. In this mode, loudness readings are continually made. The **Stop** button on the Loudness Meter screen is not active.

Alarm:

1. **Over:** The Alarm indication will only appear when Loudness has exceeded the **Reference Level** by the **Tolerance** amount.
2. **Under:** The Alarm indication will only appear when Loudness is below the **Reference Level** by the **Tolerance** amount.
3. **Both:** The Alarm indication will only appear when Loudness has exceeded or is below the **Reference Level** by the **Tolerance** amount.
4. **Off:** The Alarm indication will not appear.

Web GUI Loudness Settings: These settings are included on this screen for reference only. They cannot be changed on this screen.

1. **Standard:** This is the loudness standard by which the loudness calculation is made.
2. **Reference:** This is the set point in the loudness measurement about which

the determination is made as to whether an alarm should be displayed.

3. **LRA Window:** This is a moving window of time over which the loudness measurement is made.
4. **Window:** This may be set to **Momentary**, **Short**, or one of 22 values, ranging from one second to two hours.

Note: Further and more detailed descriptions of all of the above Loudness terms may be found in the ITU-R BS.1770-3 loudness standard.

When you have completed reviewing or changing the settings, touch the **Back** button to return to the Loudness menu.

Source Select

If you have set the **Source Knob Selection** setting in the **Unit Config** menu to **Source Select**, you may change the monitored source by simply rotating the **Source** knob.

Alternatively, touching the **Source Select** selection on the **Main Menu** proceeds to the **Source Select** menu, which shows all of the possible sources. The selected source is shown in a light color. You may simply touch another source in this menu to switch to it. This screen also shows sources which are unlicensed and therefore nonfunctional. These sources are shown in a gray color. To license these sources so that they may be used, contact Wohler Technologies. Figure 2-14 shows the Source Select Menu.

Figure 2-14: Source Select Menu

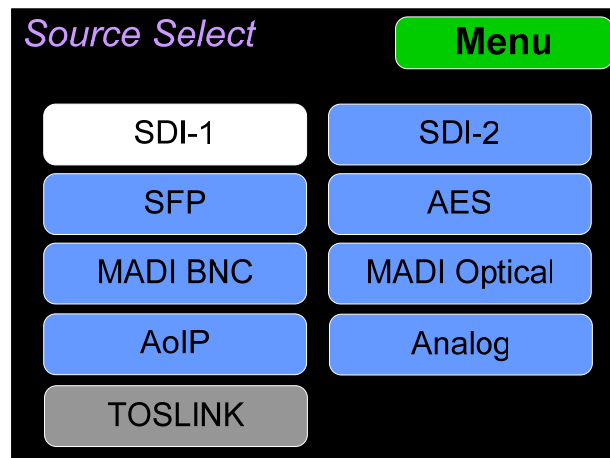

Touch **Menu** to exit this menu.

If you touch MADI BNC, MADI Optical, or SFP, an additional selection screen will be shown, asking you select which 8 MADI channels to monitor or which SFP functionality to monitor. An example of these screens is shown in Figure 2-15.

Note: AoIP, TosLink and/or Analog (DB25) sources are only available if the appropriate hardware option cards are installed on the unit. Refer to Table 3-3. If not installed, then the system will show message **Feature is not supported or requires valid hardware**, as illustrated in the last screen shown in Figure 2-15.

Figure 2-15: Additional Selection Screens:

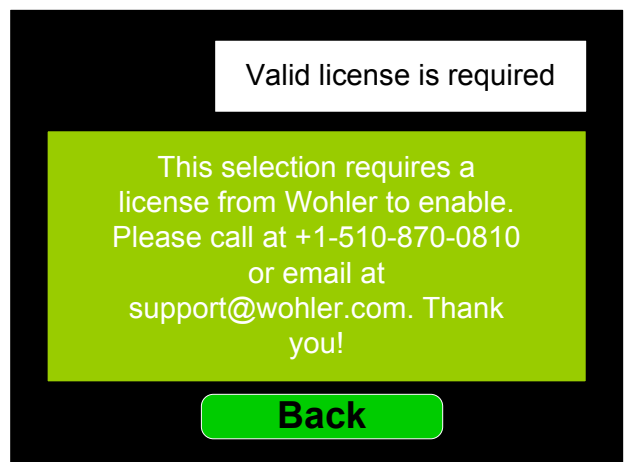
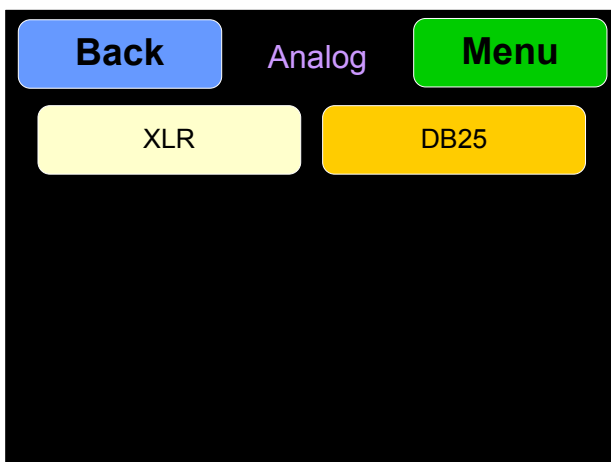
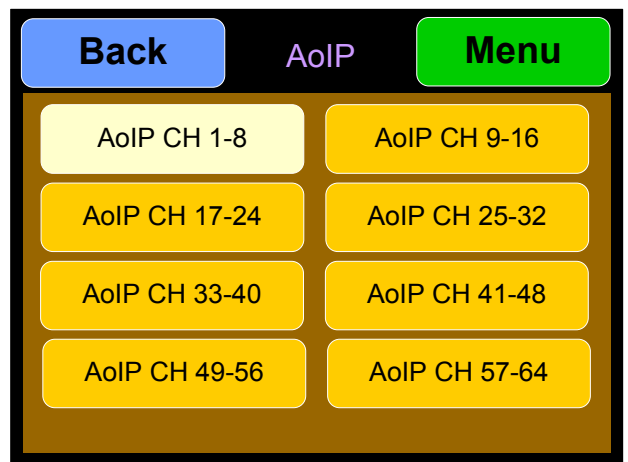
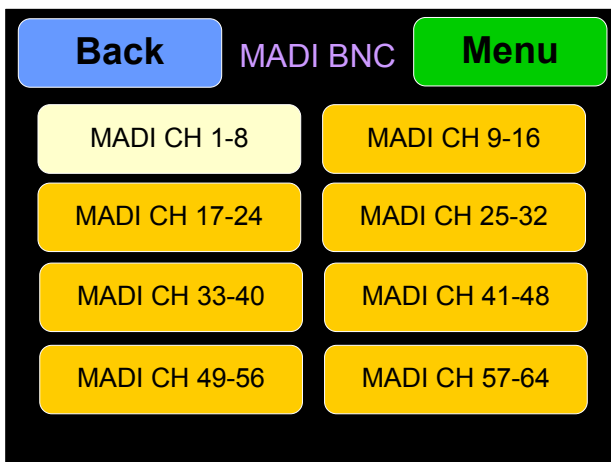
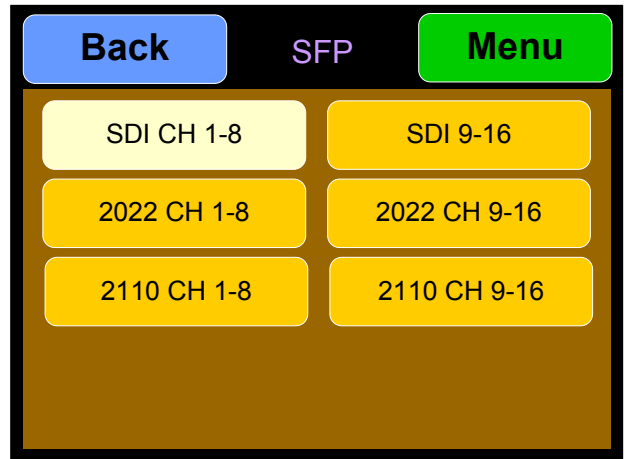
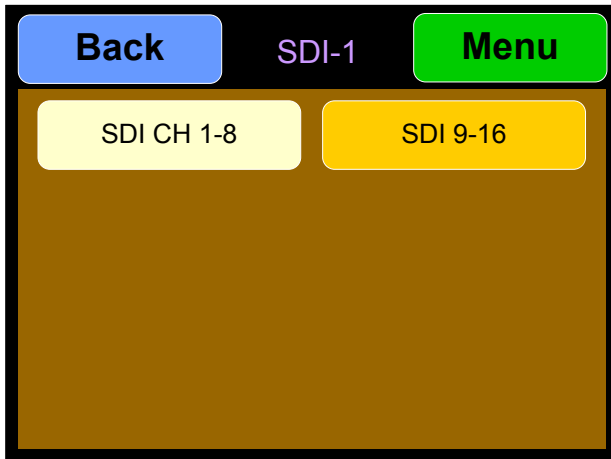

Touch **Back** to return to the **Source Select** menu or touch **Menu** to return to the **Main Menu**.

Presets

Presets are pre-arranged input and monitoring setups that can be used to monitor a variety of combinations of inputs. They may be set up to allow quick and easy selection of monitoring configurations for various productions and situations. If you have not set up any Presets, use the Configure Presets page in the Web GUI to do so. Refer to Chapter 4. Or, if you prefer not to set up any Presets, simply monitor the sources directly using the Source Select button in the Menu.

In addition to the menu access described in the following two sections, the **Source** control can be used to directly select any Preset or any Favorite Preset. Refer to the **Source Knob Select** setting in the **Unit Config** menu.

All Presets

Touch the **All Presets** button to display the All Presets Group Selection screen as shown in Figure 2-16. If no Presets have been created, the screen in Figure 2-18 appears instead.

Figure 2-16: All Presets Screen - Group Selection

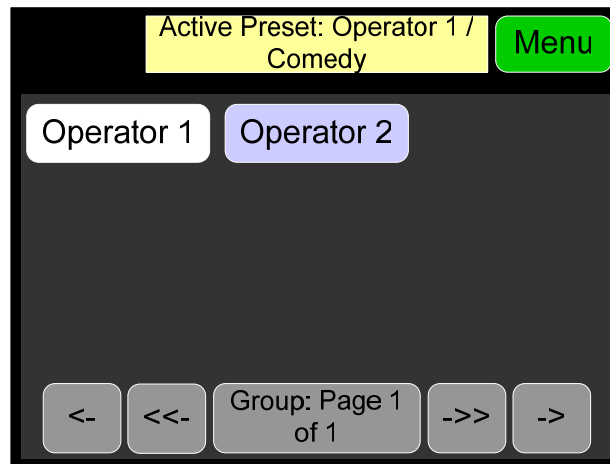

The Presets are normally arranged into Groups. Use this screen to select which Preset-containing Group to examine. After selecting one of the Groups, the Preset Selection screen shown in Figure 2-17 is shown.

Figure 2-17: All Presets Screen - Preset Selection

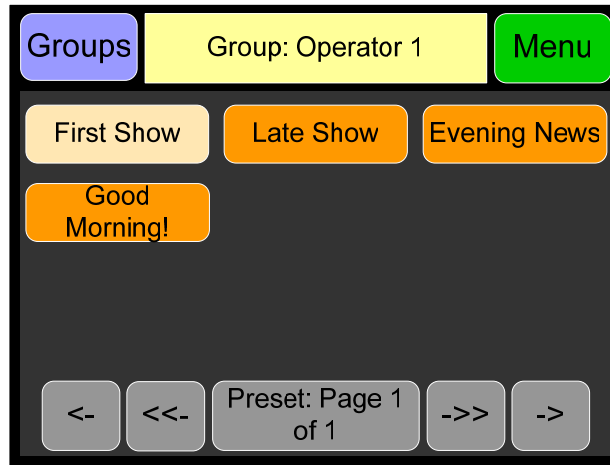

To select a Preset, touch the associated button. After a quick 2-second delay, the metering screen will display the channels contained in that source.

To return to the All Presets Group Selection screen instead, touch the **Groups** button. To return to the Menu without making a selection, touch the **Menu** button.

Figure 2-18: All Presets Screen - No Presets

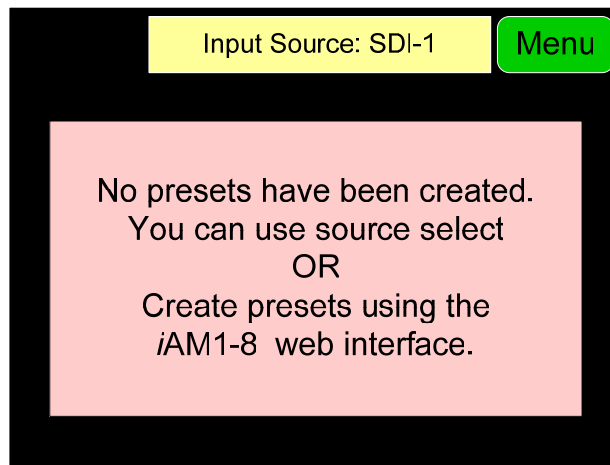

To return to the Menu from this screen, touch the **Menu** button.

Preset Favorites

Touch the **Preset Favorites** button to display the Preset Favorites screen. This shows the Presets that you have designated as Favorites. Refer to the Dashboard section of Chapter 4. Generally, these are frequently used Presets that you want to separate out from the possibly many other Presets in the system. The Preset Favorites screen is shown in Figure 2-19.

Figure 2-19: Preset Favorites Screen



In this screen, the currently selected Preset is shown in bright yellow. Touch any Preset to select it. To exit this screen without making a selection, touch **Menu**. If no Favorite Presets have been designated, this screen will appear as shown in Figure 2-20.

Figure 2-20: Preset Favorites Screen - No Favorites

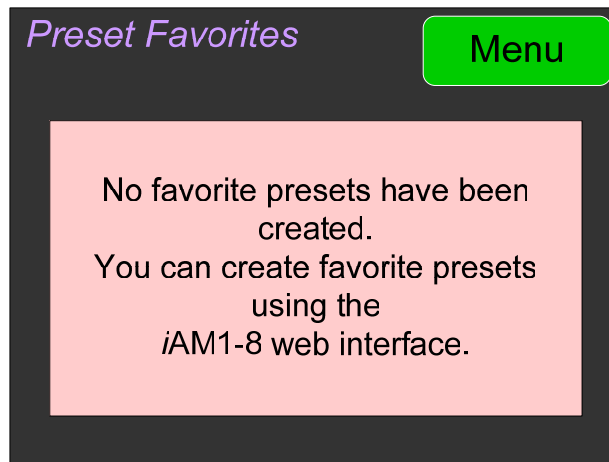

Unit Settings

Touching the **Unit Settings** selection on the **Main Menu** screen proceeds to the **Unit Settings Menu**, which contains additional menu selections. The **Unit Settings Menu** is shown in Figure 2-21. This is an intermediary menu which leads to other menus and screens.

Figure 2-21: Unit Settings Menu

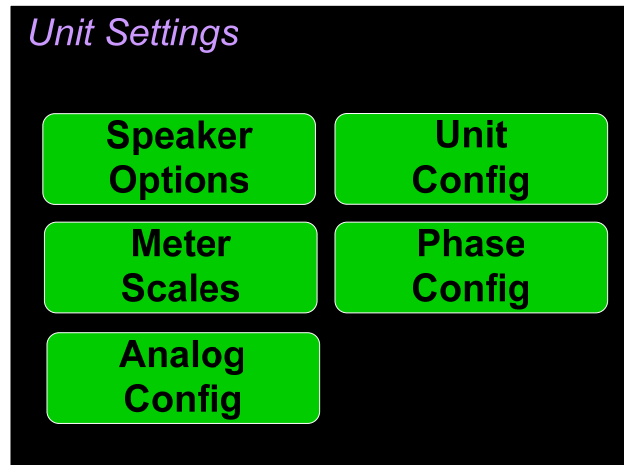

Speaker Options

Touching the **Speaker Options** selection on the **Unit Settings** Menu screen proceeds to the **Speaker Options** screen. The controls on this screen affect various characteristics of the monitored audio as heard on the *iAM-SUM*. This screen is shown in Figure 2-22.

Figure 2-22: Speaker Options Screen

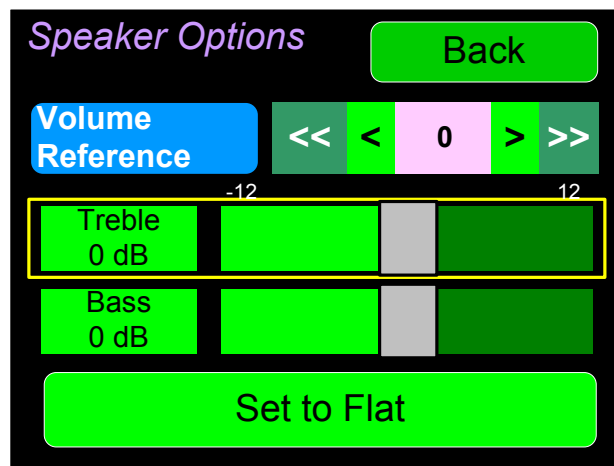

The controls function as follows:

1. **Volume Reference:** The **Volume Reference** setting controls the attenuation level of the internal speakers. The value ranges from 0 to -255 dB. 0 results in full volume and -255 causes the speakers to be muted.

2. **Treble:** This tone control adjusts the high frequency speaker audio response from -12 dB to +12 dB. Lowering **Treble** compensates for high frequency pre-emphasis or removes sibilance effects. Increasing **Treble** will add "sizzle" to the sound and bring high-pitched sounds out of the mix. The control can be touched and moved left or right to adjust in 2 dB increments. After touching the **Treble** control, the **Channel** knob can also be turned to make the adjustment.
3. **Bass:** This tone control adjusts the low frequency speaker audio response from -12 dB to +12 dB. Lowering **Bass** will unmask midrange band sounds, while increasing **Bass** will make the sound "fatter". The control can be touched and moved left or right to adjust in 2 dB increments. After touching the **Bass** control, the **Channel** knob can also be turned to make the adjustment.
4. **Set to Flat:** Touching this button will set the **Treble** and **Bass** controls to their midpoint, resulting in a flat response with 0 dB increase or decrease in treble and bass response.

Touch **Back** to exit this screen.

Unit Configuration

Touching the **Unit Config** selection on the **Unit Settings** Menu proceeds to the **Unit Config Menu**. This menu is shown in Figure 2-23.

Figure 2-23: Unit Configuration Menu

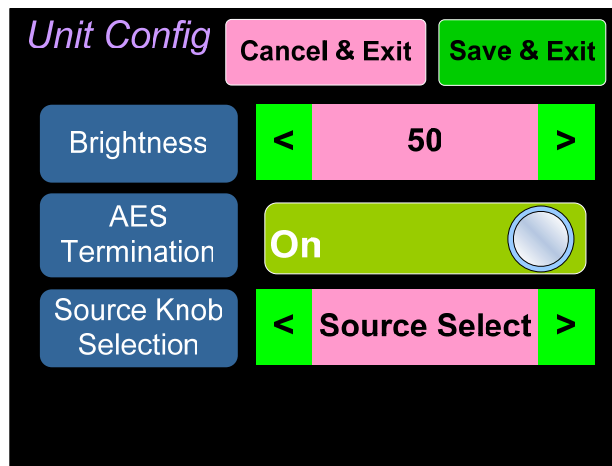

The controls function as follows:

1. **Brightness:** This setting adjusts the brightness of the display screen. Touch the left pointing arrow to dim the brightness or touch the right pointing arrow to increase the brightness.
2. **AES termination:** AES signals should have one and only one termination. This termination should physically be at the last destination of an AES coax cable. If the *iAM-SUM* is the last connection in a series of AES connections, then its terminations should be turned on. A symptom of too many terminations (or no termination) is that no signal appears to be present on

the AES input. Touch the On - Off switch to change the termination setting.

3. **Source Knob Selection:** This setting determines the function of the **Source** knob on the front panel. It may be set as follows, depending upon your needs:
 - a. **Source Select:** The **Source** knob will select the input source to be monitored.
 - b. **All Presets:** The **Source** knob will select between any Presets present in the unit.
 - c. **Favorite Presets:** The **Source** knob will select between any of the Favorite Presets present in the unit.
 - d. **No Operation:** The **Source** knob will perform none of the above listed selection operations. If the **Source** knob is set to **No Operation** and is turned, the Audio Meters screen will display **No Operation** for 3 seconds at the top center, as a reminder.

Note: Regardless of the **Source Knob Selection**, the **Source** knob is used to select clusters when in the Loudness Meter Screen.

Touch **Cancel & Exit** or **Save & Exit** to exit this menu.

Meter Scales

Touching the **Meter Scales** button on the **Unit Settings** Menu displays the **Meter Scales** screen as shown in Figure 2-24. The controls on this screen select the scale standards as well as the ballistics that will be applied to the audio meters.

Figure 2-24: Meter Scales Screen

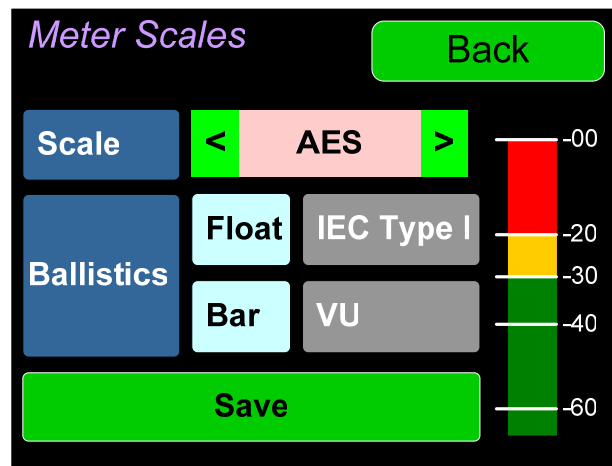

The controls function as follows:

1. **Scale:** This meter scales standard to be used when displaying audio levels. A choice of seven scales is available. Touch the left or right arrows to select the scale. A representation of the chosen scale will be shown at the right. The possible scales that can be selected are shown in Figure 2-25.

Figure 2-25: Meter Scale Selection

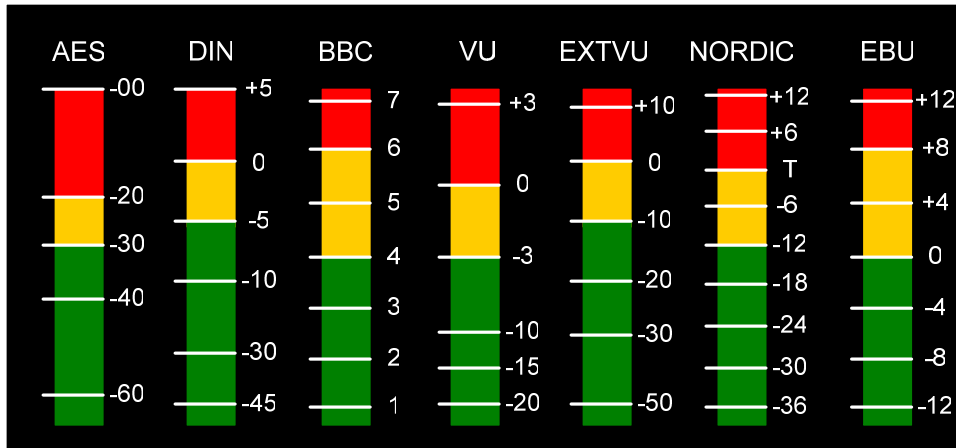

Table 2-4: Meter Limits and References

Scale	Bottom Limit	Top Limit	Default Reference	Default Color Bounds		Default Ballistics	
				Lower	Upper	Float	Bar
AES	-72 dBFS	0.0 dBFS	0 dBFS = 0 dBFS	-30 dBFS	-20 dBFS	IEC Type I	VU
DIN	-53 dBr	+5.5 dBr	-15 dBFS = 0 dBr	-5 dBr	0 dBr	—	IEC Type I
BBC	-13.25 dBr	+13.0 dBr	-18 dBFS = 0 dBr	0 dBr	8 dBr	—	IEC Type I
VU	-45 dBr	+3.5 dBr	-20 dBFS = 0 dBr	-3 dBr	0 dBr	—	VU
EXTVU	-56 dBr	+16.0 dBr	-20 dBFS = 0 dBr	-10 dBr	0 dBr	—	VU
NORDIC	-44 dBr	+12.5 dBr	-18 dBFS = 0 dBr	-10 dBr	0 dBr	—	IEC Type I
EBU	-13.25 dBr	+13.0 dBr	-18 dBFS = 0 dBr	0 dBr	8 dBr	—	IEC Type I

2. **Ballistics:** The Bar and Float ballistics associated with the selected meter scale are displayed. Refer to Table 2-5. Ballistic timings are valid only at 48 kHz.

Table 2-5: Meter Timings

Ballistics	Rise	Fall	
		Level Change	Time
VU	Not Specified		
IEC Type I	5 ms to reach -2 dB of settled reading	-20 dB	1.7 sec.
IEC Type II	10 ms to reach -2 dB of settled reading	-24 dB	2.8 sec.
None	Bar or Floating Segment Not Displayed		

When you have made your choices, touch **Back** to exit this screen.

Phase Configuration

Touching the **Phase Config** selection on the **Unit Settings** Menu proceeds to the **Phase Config Menu**. This menu is shown in Figure 2-26 for each of the *iAM-SUM* models.

Figure 2-26: Phase Configuration Menu

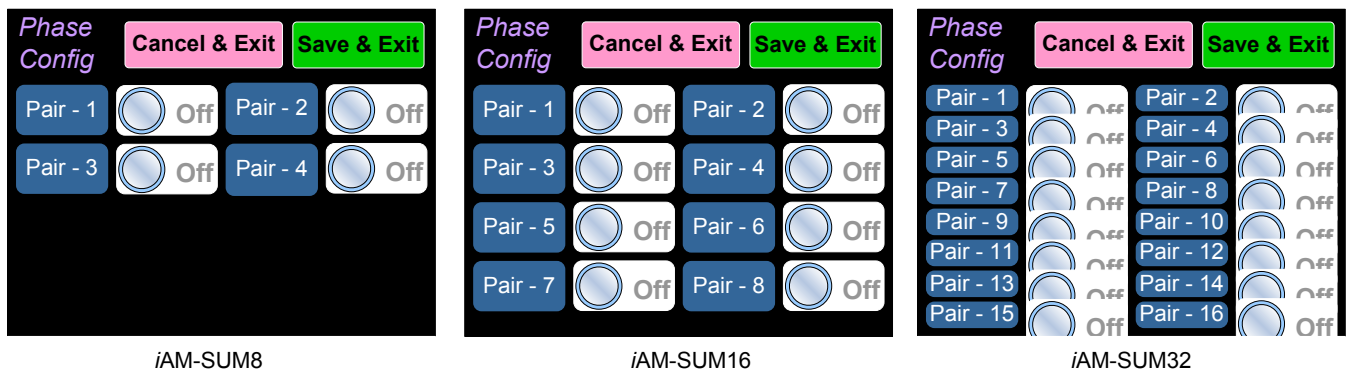

Analog Configuration

Touching the **Analog Config** button in the **System Options Menu** displays the **Analog Config** screen. Contained in this menu is an **Analog Reference** as illustrated in Figure 2-27. The parameters set on this screen pertain to the **Analog Input** and **Analog Output** DB25 and XLR connectors on the rear panel of the iAM-SUM.

Figure 2-27: Analog Configuration Menu

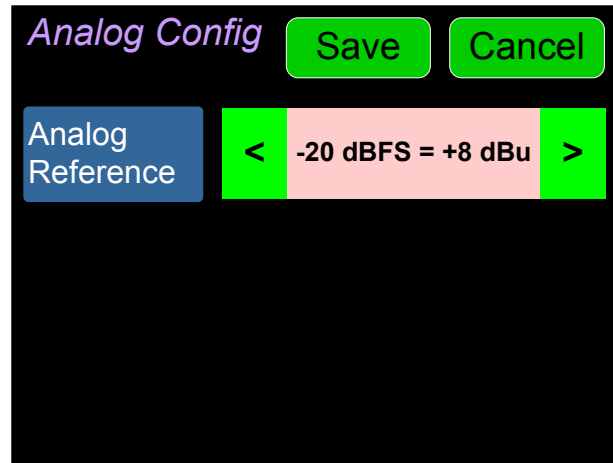

There is only one setting on the **Analog Reference** menu:

1. **Analog Reference:** This setting adjusts the relationship between the monitored digital signal level and the analog signal level that is output from both of the DB25 and both of the XLR connectors on the back panel. The default setting is -20 Dbfs = +8 dBu as shown in Figure 2-29. The range of possible settings is as follows:
 - a. -20 dBFS = +8 dBu
 - b. -20 dBFS = 0 dBu
 - c. -22 dBFS = +4 dBu
 - d. 0 dBFS = +15 dBu
 - e. -16 dBFS = +4 dBu
 - f. -18 dBFS = +4 dBu
 - g. -18 dBFS = 0 dBu
 - h. -20 dBFS = +4 dBu

Touching **Save** will save any changes made, or touching **Cancel** will return you to the **System Options** menu without saving.

System Options Menu

Touching System Options in the **Main Menu** proceeds to the **System Options** menu, which is an intermediate menu leading to other screens. This menu is shown in Figure 2-28.

Figure 2-28: System Options Menu

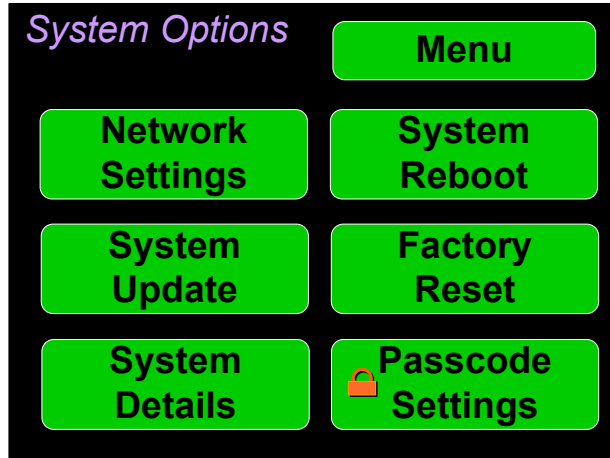

Touch **Menu** to exit this menu.

Network Settings

Touch the **Network Settings** selection on the **System Options** Menu displays the **Network Settings** menu as shown in Figure 2-29. This screen lets you view or change the product IP, the Net Mask, Gateway and DNS. It also lets you switch between a static (fixed) or a dynamic (DHCP) network address.

Figure 2-29: Network Settings Screen

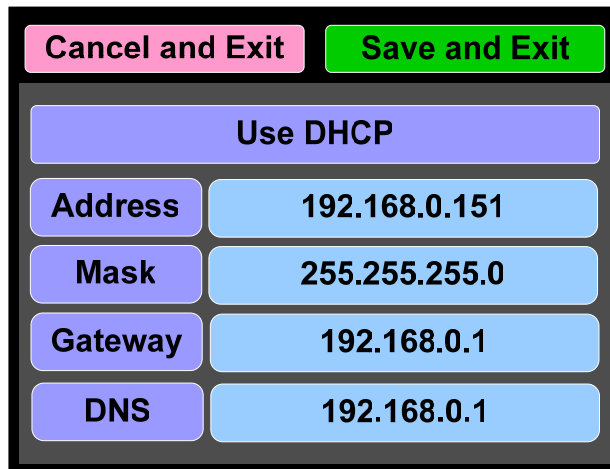

1. To change the IP Address, Net Mask, Gateway, or DNS, tap the item you would like to change. A keypad will appear, as shown in Figure 2-30.

Figure 2-30: Network Configuration: Setting Change

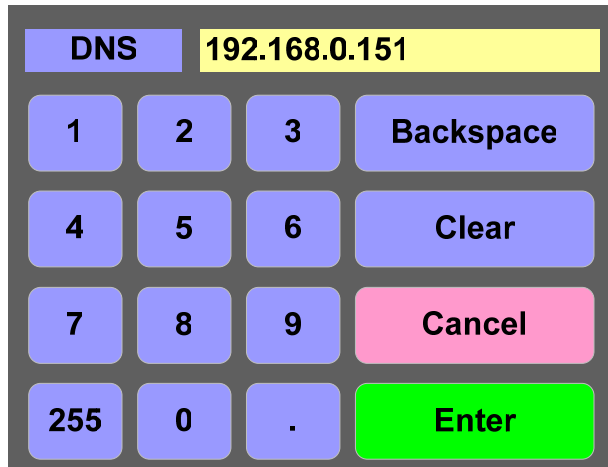

2. Touch the digits to be entered and then touch the **Enter** button. The **Clear** button may be touched to erase any mistyped digits.
3. Now repeat steps 1 and 2 until you have replaced all of the necessary digits.
4. To save the newly entered address, touch the **Enter** button. Touch the **Cancel** button to return to the previous screen without saving any changes.

Important:

There is no confirmation for **Save**, so make sure you want to perform this action before taking it. The system does not need to reboot before it is once again ready for operation.

To change from a static (fixed) to a dynamic (DHCP) network address, touch the **DHCP** button. The screen will change, as shown in Figure 2-31. To change back to a static (fixed) network address, touch the **DHCP** button again. The colors of the buttons will return to the ones depicted in Figure 2-29.

Figure 2-31: Network Settings: DHCP

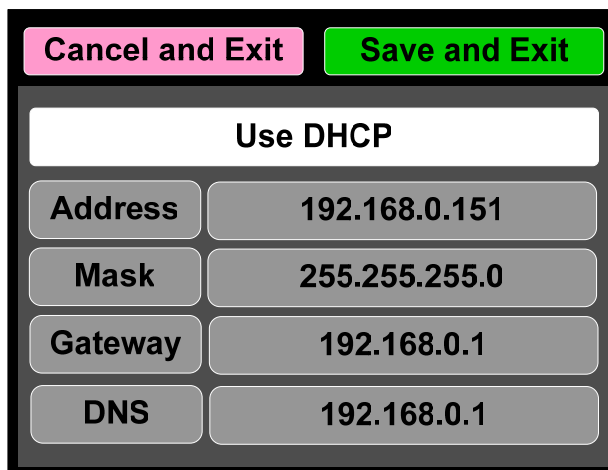

1. To complete the network addressing scheme change, touch the **Save** button.

This will save the changes you selected.

2. Touch the **Cancel** button to return to the previous screen without saving any changes.

Important:

There is no confirmation for **Save and Exit**, so make sure you want to perform this action before taking it. The system will not need to reboot before it is once again ready for operation.

System Reboot

Touching the **System Reboot** selection on the **System Options** Menu displays the **System Reboot** screen as shown in Figure 2-32. This function is normally only used upon request from Wohler Technical Service to troubleshoot or correct an issue.

The **System Reboot** function should be used with a bit of forethought. It puts the system out of service for several minutes while it is rebooting.

Figure 2-32: System Reboot

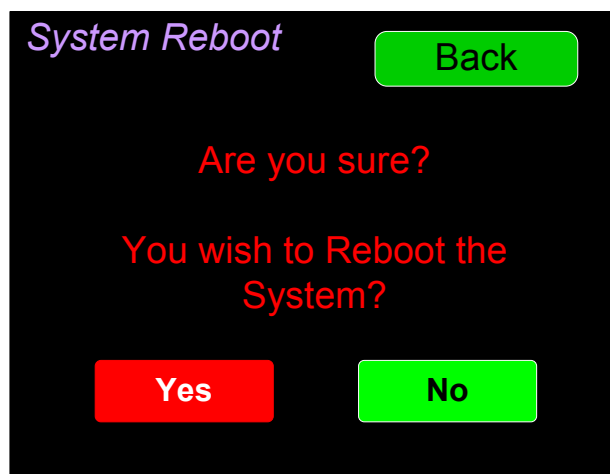

If you have any doubt as to whether you should press **Yes**, press **Back** or **No** instead, and contact Wohler Technical Service for advice. Pressing **Back** or **No** will return you to the **System Options** menu.

System Update

Touching the **System Update** selection in the **System Options** Menu displays **System Update** screen as shown in Figure 2-33, showing the current software version of the product. To update the system software locally from the *iAM-SUM* front panel, follow the procedure in the **Local Update from the Front Panel** section of Appendix A.

Figure 2-33: System Update Screen

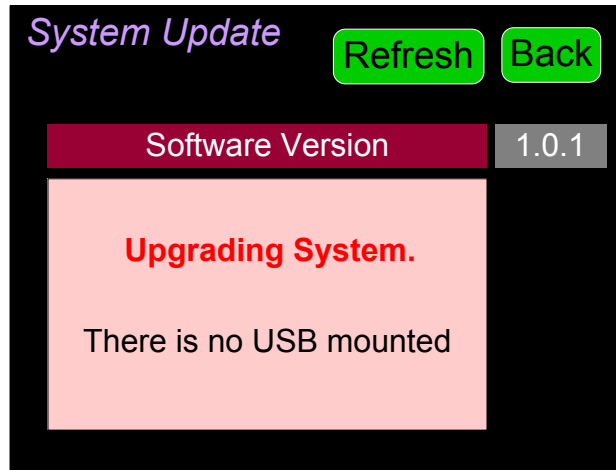

If you have just inserted a flash drive with a valid software upgrade package, press **Refresh** to see that package.

Touch the **Back** button return to the **System Options Menu**.

Factory Reset

Touching the **Factory Reset** selection in the **System Options** menu displays the **Factory Reset** screen as shown in Figure 2-34. Because of the large change this function is about to make to the product, it asks for you for verification that you really want to proceed.

The **Factory Reset** function should be used with caution. It deletes all of the settings you have programmed into the system. It returns the system to the way it was when received new from the factory. After using this function, you will need to use the Wohler Web GUI to reprogram everything from the start.

Figure 2-34: Factory Reset

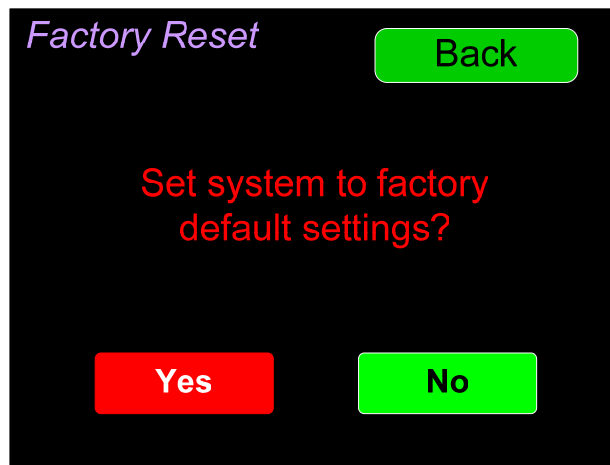

Note: **Factory Reset** will also reset your IP address to the default one. After a Factory Reset, the IP Settings will need to be updated. The default IP address for the unit is determined based upon the Mac address. It is 169.254.1.xx where xx is the last octet of the management Mac address. For example, if the Mac address is b4:ed:54:d0:04:28 then the IP address would be 169.254.1.40 (40 is the decimal equivalent for the last octet of Mac address 28.)

If you have any doubt as to whether you should press **Yes**, press **Back** or **No** instead, and contact Wohler Technical Service for advice. Pressing **Back** or **No** will return you to the **System Options** menu.

System Information

Touching the **System Details** selection in the **System Options** menu displays the **System Details** screen as shown in Figure 2-35. This screen lets you view the product Serial Number, Software Version, and various other information.

Figure 2-35: System Details Screen

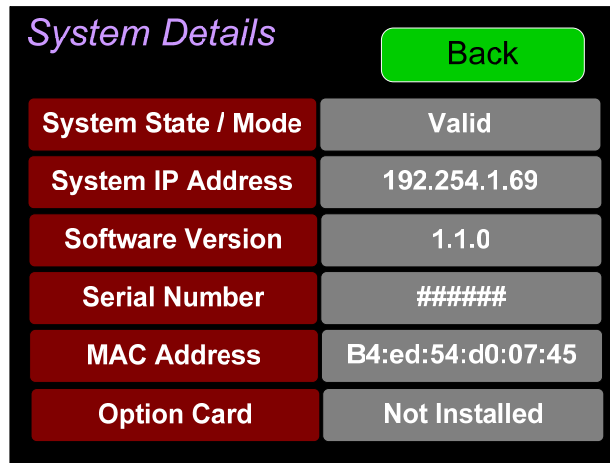

The screenshot shows a screen titled "System Details" with a green "Back" button in the top right corner. Below the title is a table with six rows, each representing a different system parameter. The first column of the table contains the parameter names, and the second column contains their corresponding values.

<i>System Details</i>	
System State / Mode	Valid
System IP Address	192.254.1.69
Software Version	1.1.0
Serial Number	#####
MAC Address	B4:ed:54:d0:07:45
Option Card	Not Installed

The information shown on this screen is read only and cannot be changed. Touch **Back** to return to the **System Options** Menu.

Passcode Settings

To prevent accidental or unauthorized changing of critical settings in some of the menus, it is possible to block or restrict access to various menus. The Wohler Web GUI can be used to limit access to the menus of your choice. Refer to Chapter 4, the **Front Panel Configuration** tab of **System Preferences**.

The iAM-SUM contains a **Passcode Settings** screen. Access to this screen is always protected by a unique Passcode, which you can set. Note that the protection of the **Passcode Settings** selection is indicated by an orange lock icon:  The **Passcode Settings** button on the **System Options** screen contains this icon, as shown in Figure 2-36. The factory default Passcode is 0-0-0-0.

Figure 2-36: System Options - Passcode Settings Lock



Touching the **Passcode Settings** selection in the **System Options** menu proceeds to the **Passcode Entry** screen as shown in the left image of Figure 2-37.

Figure 2-37: Passcode Entry Screen

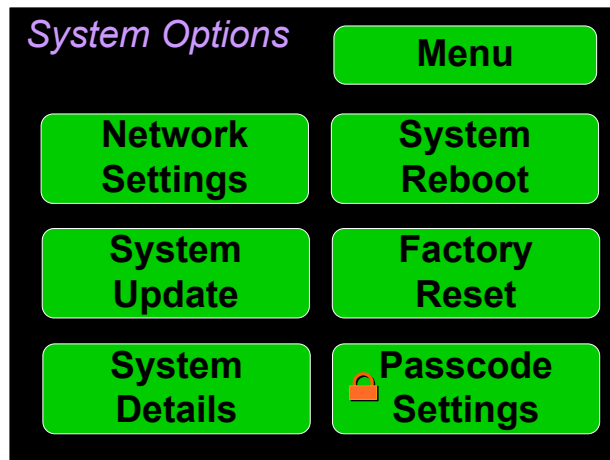
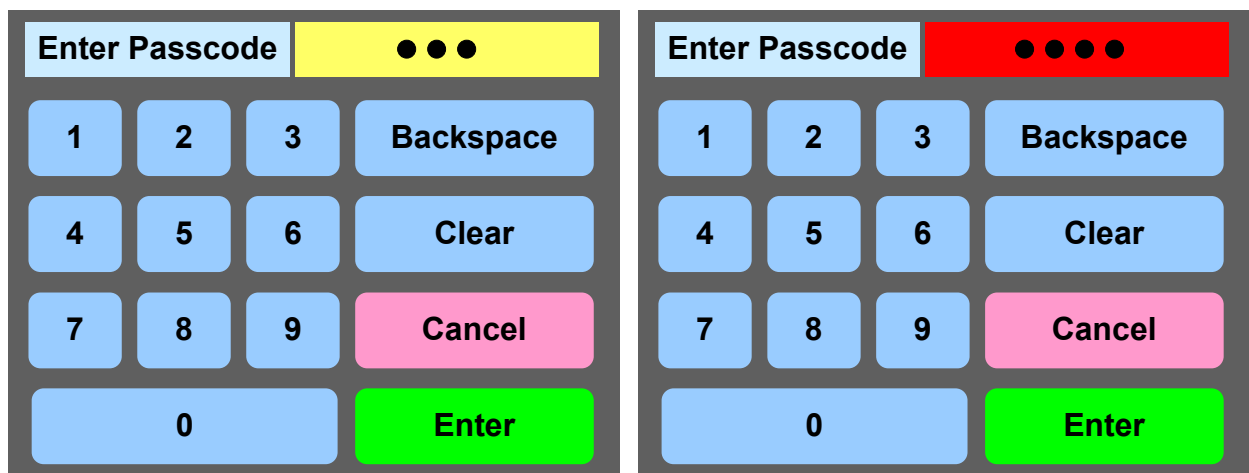

Enter the Passcode on the keypad and touch **Enter**. The numbers will display as bullets in the field. If you enter the wrong Passcode, the entry field will turn red, as shown on the right image of Figure 2-37. Press **Clear** and try again.

When you have successfully entered the Passcode, the Passcode Settings screen will appear, as shown in Figure 2-38.

Figure 2-38: Passcode Settings Screen

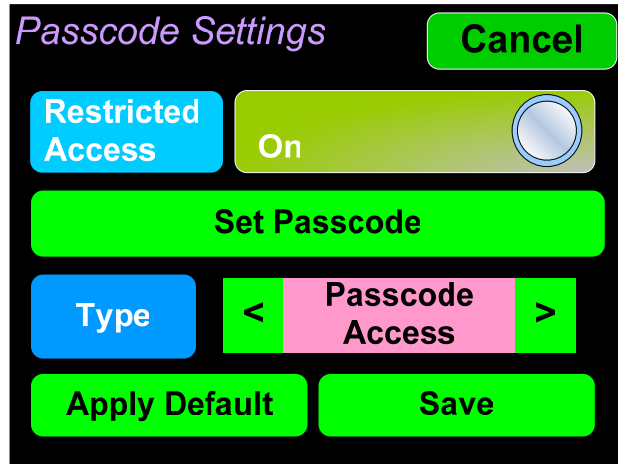

The functions on this screen are as follows:

Restricted Access: This switch will turn ON or OFF protection or blocking of any menus, except for the Passcode Settings menu, which is always Passcode protected.

Set Passcode: Touching this button proceeds to a keypad which allows you to enter a new Passcode. The screen shown in Figure 2-39 will appear. The Passcode can be any 4-digit number. Touch **Enter** to save the new Passcode or touch **Cancel** to keep the previous Passcode. Be sure to save the Passcode in a safe place for future reference.

Figure 2-39: Set Passcode Screen

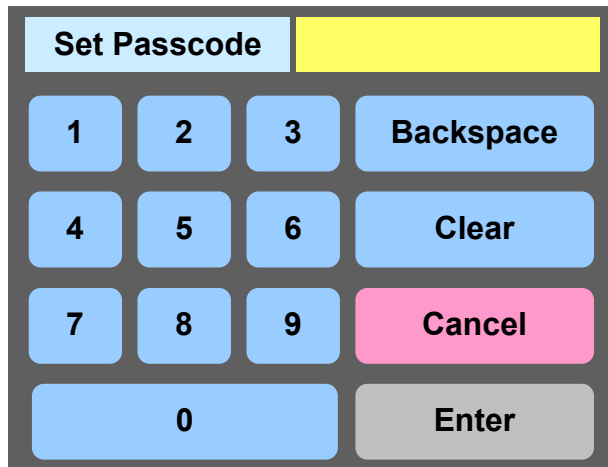

Type: Select the type of disabled button appearance using the **Type** button. The choices are:

Passcode Access: The Passcode protected function buttons include a small orange padlock icon within the buttons. This is shown in the left image of Figure 2-40. Touching these buttons will cause a Passcode entry screen to appear, as shown in the left image of Figure 2-37. The correct Passcode must

be entered to proceed.

No Access: If the function buttons are protected by No Access, the buttons are grayed out and non-functional, as shown in the right image of Figure 2-40. These buttons cannot be accessed at all unless the restricted protection is removed by switching OFF the **Restricted Access** setting in this menu.

Figure 2-40: Examples of Menu Protection

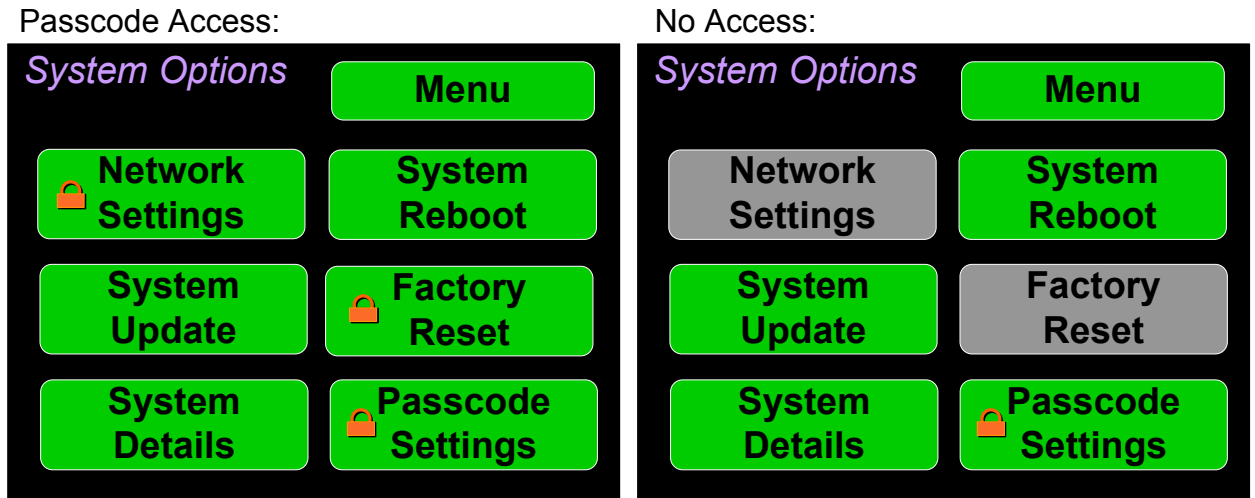

Apply Default: Touching this button returns the settings in this screen to the factory default values. The Passcode becomes 0-0-0-0.

Save: Touching this button saves the settings made in this screen and returns to the **System Options** screen.

Forgotten Passcode

Although the Passcode should be remembered or securely noted somewhere, it can happen that it is forgotten. This can be remedied by performing a Factory Reset from the Wohler Web GUI. Unfortunately, this will also erase all of the menu settings. You may also contact Wohler Technical Service for help.

CHAPTER 3: Technical Info

Table 3-1: iAM-SUM Specifications

Specification	Values/Domains
Power Requirements	100 VAC to 240 VAC \pm 10%, 50/60Hz
Power Consumption	65 Watts
Dimensions (H x W x D)	1.75" x 19" x 5.5" (44mm x 483mm x 140mm), standard 19" rack mounting
Shipping/Net Weight	8 lbs. (3.6 kg) / 5.5 lbs. (2.5kg)
Supplied Accessories	AC Power Cord
Display Type	7" Capacitive Touchscreen LCD
Screen Resolution	1242H x 280V
Viewing Angle	160 (H) x 160 (V)
Audio Channels	8, 16, or 32 depending upon model
Level Meters	Simultaneous Average & PPM
Level Meter Scale	Choice of AES, BBC, DIN, EBU, EXTVU, NORDIC, or VU
Sample Rate	48kHz
De-Multiplexing	8, 16, or 32 channels (depending upon model) from: <ul style="list-style-type: none"> • 16-channel SD/HD/3G-SDI • 64-channel AES10 MADI
SDI Inputs / Outputs	<ul style="list-style-type: none"> • 2 SDI Inputs and 1 SDI Output Optional – Single SFP Transceiver: <ul style="list-style-type: none"> • HD-BNC Coax 3G/HD/SD-SDI • Multi-Mode Fiber: 1 SI Optical SC-Connector, 1300nm • Single-Mode Fiber: 1 SI Optical SC Connector, 1310nm
MADI Inputs / Outputs	<ul style="list-style-type: none"> • 1 MADI BNC, Standard Coax I/O Optional – SFP Transceiver: <ul style="list-style-type: none"> • Multi-Mode Fiber: 1 MADI Optical SC-Connector, 1300nm • Single-Mode Fiber: 1 MADI Optical SC Connector, 1310nm
SMPTE 2022-6 Receiver	Optional - SFP Receiver: <ul style="list-style-type: none"> • Multi-Mode Fiber: LC Connectors, 850nm
SMPTE 2110 Receiver	Optional - SFP Receiver: <ul style="list-style-type: none"> • Multi-Mode Fiber: LC Connectors, 850nm

Specification	Values/Domains
Cable/Fiber Length (max)	COAX (such as Belden 1694A): > 150 m
	Single-mode fiber: 10 km
AES Inputs	8 AES channels on HD-15 are optional
AES Outputs	8 AES channels on HD-15
Upgrades	Via USB or GUI web interface
SDI Input Termination	75Ω unbalanced
AES/EBU Input Termination	75Ω unbalanced
AES/EBU/MADI Sampling Rate	48 kHz
Analog Inputs - Stereo	XLR-3 Female, balanced
Analog Input Impedance	40kΩ balanced
Analog Outputs - Stereo	XLR-3 Male, balanced +28 dBu max
Analog I/O – Multi-channel	8 Balanced Input Channels and 8 Balanced Output Channels on 2 x DB25F (optional)
Analog Output Frequency Response	40 Hz to 20 kHz (± 1dB)
Analog Output Distortion	<0.02% THD+N
Analog Output Dynamic Range	> 100 dB
Analog Output Reference Level	-20 dBFS = +4 ± 1.0 dBU
Internal Speakers - Stereo	70mm Full Range
Peak Acoustic Output	90 dB SPL (@ 2 feet)
Hum and Noise	Better than -68 dB below full output
Power Output	5 Watts RMS, 12 Watts peak (each side)
Acoustic Frequency Response	150 Hz to 16 kHz (± 5 dB)
Headphone Out - Stereo	40 Hz to 20 kHz (± 1 dB)
Headphone Load	8Ω to 150Ω

Table 3-2: iAM-SUM Options

Option	Part #	Description
SFP-MM-MADI-Fiber	829081	MADI optical fiber transceiver. Multi-Mode, LC (fiber) connectors. SFP module with software activation key.
SFP-SM-MADI-Fiber	829082	MADI optical fiber transceiver. Single-Mode, LC (fiber) connectors. SFP module with software activation key.
SFP-SDI	829089	3G/HD/SD-SDI single video receiver with active loopback, HD-BNC connectors. SFP module with software activation key.
SFP-SDI-Fiber	829084	3G/HD/SD-SDI video SFP optical input; LC (fiber) connectors; Single-Mode Receiver, Medium Haul, Non-MSA, no output.
SFP-2022-6	829088	SMTPE 2022-6 receiver; Multi-Mode 850 NM, LC (fiber) connectors. SFP module with software activation key. Use MN-Set** to configure SFP.
SFP-2110 w/Ember+	829086	SMTPE 2110 receiver; Multi-Mode 850 NM, LC (fiber) connectors. SFP module with software activation key. Use MN-Set** to configure SFP.
SFP-2110 w/NMOS	829086-1	SMTPE 2110 receiver; Multi-Mode 850 NM, LC (fiber) connectors. SFP module with software activation key. Use MN-Set** to configure SFP.
SFP-2110 w/Ember+ +2022-6	829087	SMTPE 2110 or 2022-6 receiver; Multi-Mode 850 NM, LC (fiber) connectors. SFP module with software activation key. Use MN-Set** to configure SFP.
SFP-2110 w/NMOS +2022-6	829087-1	SMTPE 2110 or 2022-6 receiver; Multi-Mode 850 NM, LC (fiber) connectors. SFP module with software activation key. Use MN-Set** to configure SFP.
OPT-AES	829080	Enables decoding and monitoring of 4 x AES inputs on an HD-15 connector and 1 AES output on BNC connector. Requires a software activation key.
OPT-MADI	829092	Enables decoding and monitoring of 1 x MADI64 input. BNC connectors. Requires a software activation key.

OPT-OUTPUT-ROUTING	829159	Enables the flexibility to route signals from any inputs to various outputs.
--------------------	--------	--

****MN-Set** is configuration software that is necessary so that you can set up this module. It is available at no cost either from its manufacturer, Embrionix, or by contacting Wohler Technologies Technical Service.

Table 3–3: iAM-SUM Option Cards

Option	Part #	Description
OPT-ANLG/TOS (iVAM)	829170	Enable monitoring of 8 Analog channels on DB-25. TOSLINK included.
OPT-DANTE (iVAM)	829171	Enable decoding and monitoring of Dante™ input streams. Includes AoIP card. Enables 2 x RJ-45 ports for 2022-7 support (for Dante, Ravenna and 2110-30) + SFP cage allowing MM and SM SFP's for AoIP Signals. TOSLINK included.
OPT-RAVENNA 64 (iVAM)	829172	Enable monitoring of up to 64 Ravenna™ / AES67 input. NMOS support. TOSLINK included.
OPT-SFP	829179	Adds two additional 3G inputs to 3G products, or two 12G inputs to 12G products.

Figure 3-1: iAM-SUM Block Diagram

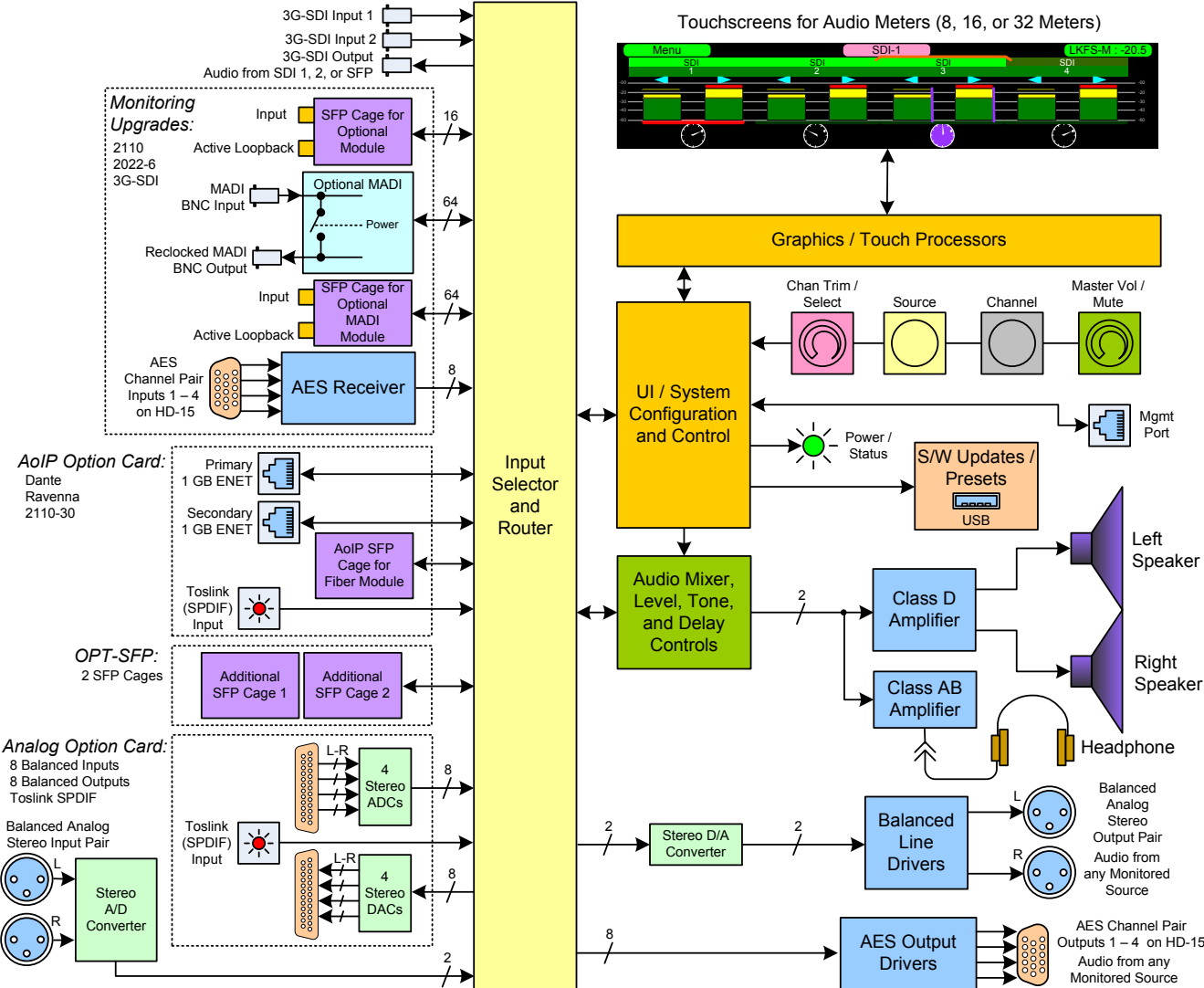

CHAPTER 4: The *iAM-SUM* Web GUI

The self-contained *iAM-SUM* Web GUI allows you to customize the configuration of the *iAM-SUM* to suit your needs. If the default configuration suits your needs and you prefer to use it that way, then you do not need to use the *iAM-SUM* Web GUI.

The *iAM-SUM* Web GUI also allows you to have a remote view of the Meter Screen. Refer to the Audio Meters section in this chapter.

Web Browser / Control Device

Any web browser application running on any networked device such as desktop or laptop computer, tablet or smart phone can be used with the *iAM-SUM* Web GUI.

Tablets with no network connector need to be linked to a copper LAN through a Wi-Fi adapter.

Although they can be used, smart phones are not recommended because their smaller screen size would require more scrolling, making operation challenging.

The Chrome[®] web browser is recommended for speed and compatibility.

First Time IP Assignments

The *iAM-SUM* can operate with a static (fixed) or dynamic (DHCP) IPv4 address. The default address will be **169.254.1.x** where x depends upon the MAC address of the unit, when received from the factory or when switched from DHCP to static addressing mode. The exact IP address is found on the **System IP Address** line of the **System Details** screen of the *iAM-SUM*. There two basic types of connections that may be used to connect the *iAM-SUM* to a web browser, a **Peer-to-Peer Connection** or a **Network Connection**.

Peer-to-Peer Connection

The most straightforward way to connect the *iAM-SUM* to a web browser, free of possible network conflicts, is to establish a static peer-to-peer connection between the setup computer and the *iAM-SUM*. A 10/100/1000 MHz Ethernet switch may be used in between, but is not required.

Figure 4-1 shows an example of suitable address settings for the host computer in a Windows control panel. For Peer-to-Peer the IP address of windows should be in 169.254.1.x domain. The exact IP address is found on the **System IP Address** line of the **System Details** screen of the *iAM-SUM*.

Figure 4–1: Host IP Settings

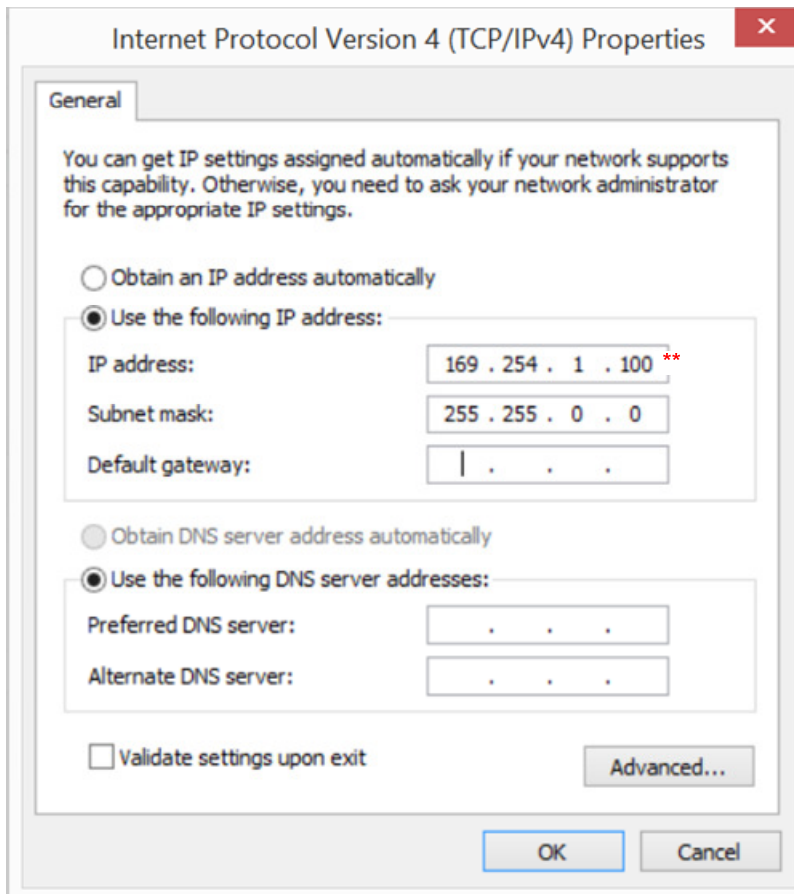

** The actual IP address to enter here is located on the System IP Address line of the System Details screen.

Close the control panel and reboot the host computer after making an IP address change to be sure the change takes effect. **Either reconnect to the installed network or continue with this direct connection to access the *iAM-SUM* Web GUI.**

Network Connection

When connected to a network, the *iAM-SUM* address will need to be changed to another address in order to be compatible with the address assignments for that particular network. Immediately after the host setup is complete, change the *iAM-SUM*'s address. Make the corresponding address, mask and gateway changes in the *iAM-SUM* **Network Setup** page. Refer to the **Network Setup** section which follows.

Otherwise set the *iAM-SUM* to DHCP address mode by checking the box for 'Use DHCP?' in Network Setup and have your IT administrator assign rights and settings for operation on the network. Allow enough time for your network's DHCP server to recognize a new network device and assign an address after booting.

The *iAM-SUM* uses link local addressing for its internal network, so no accommodation for this need be made in the network.

Network Setup

Make network **IP Address** changes for the local *iAM-SUM* **Management (MGMT) Port** here.

Figure 4–2: Set IP Addresses

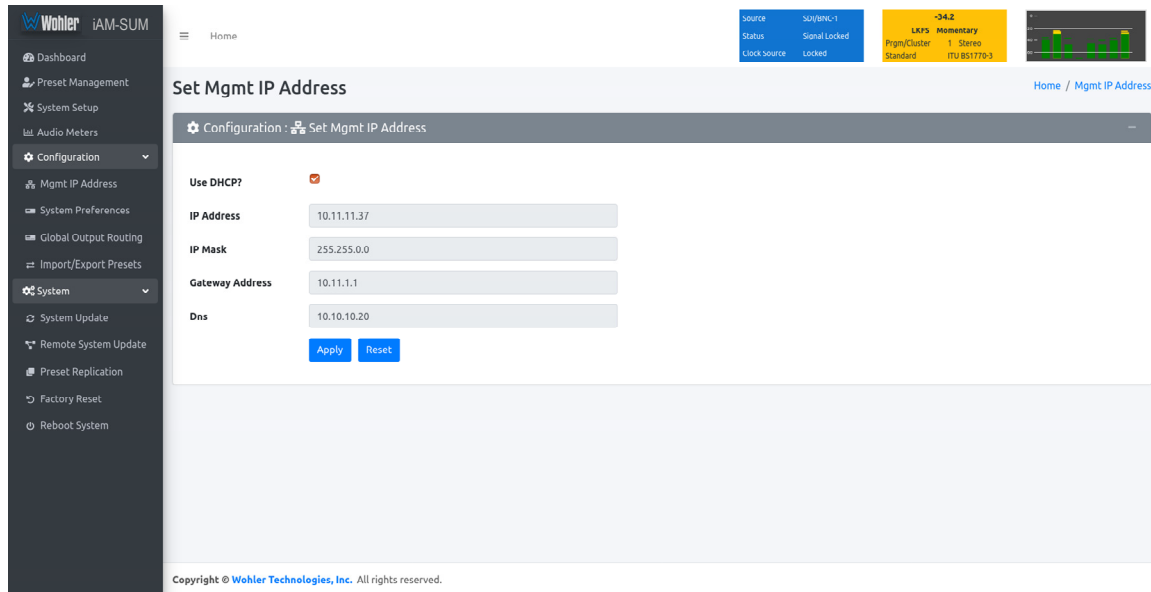

The procedure for changing the IP Address information is as follows:

1. **Use DHCP?** Check this box if your network has a DHCP server and you want to use dynamic addressing. Otherwise, you must enter static IP address entries in the four fields which follow.
2. **IP Address:** Enter the network address. Leading zeroes are not required.
3. **IP Mask:** This should usually be 255.255.255.0 unless your network can work across multiple subnets.
4. **Gateway Address:** This should usually be the same domain and subnet address numbers as the IP Address, but with the last octet being .1.
5. **DNS-nameserver:** A default value is shown for reference only. DNS is not normally required for basic static IP network configurations to work. Your IT administrator will specify a value to work with mixed static/dynamic network setups.
6. **Apply:** When you have made all of the necessary entries, press **Apply** to apply the changes.
7. **Reset:** If you should start to make changes and then change your mind about making them, press **Reset** to return the settings back to where they were.

Dashboard

Throughout the Web GUI, pages are a click or two away using the list of selections on the left side. The **Dashboard** page shows all of the available Preset configurations at a glance. The *iAM-SUM* allows you to assign Presets to particular groups. In Figure 4-3, two groups, Operator-1 and Operator-2 are shown.

Figure 4-3: Dashboard Preset Overview

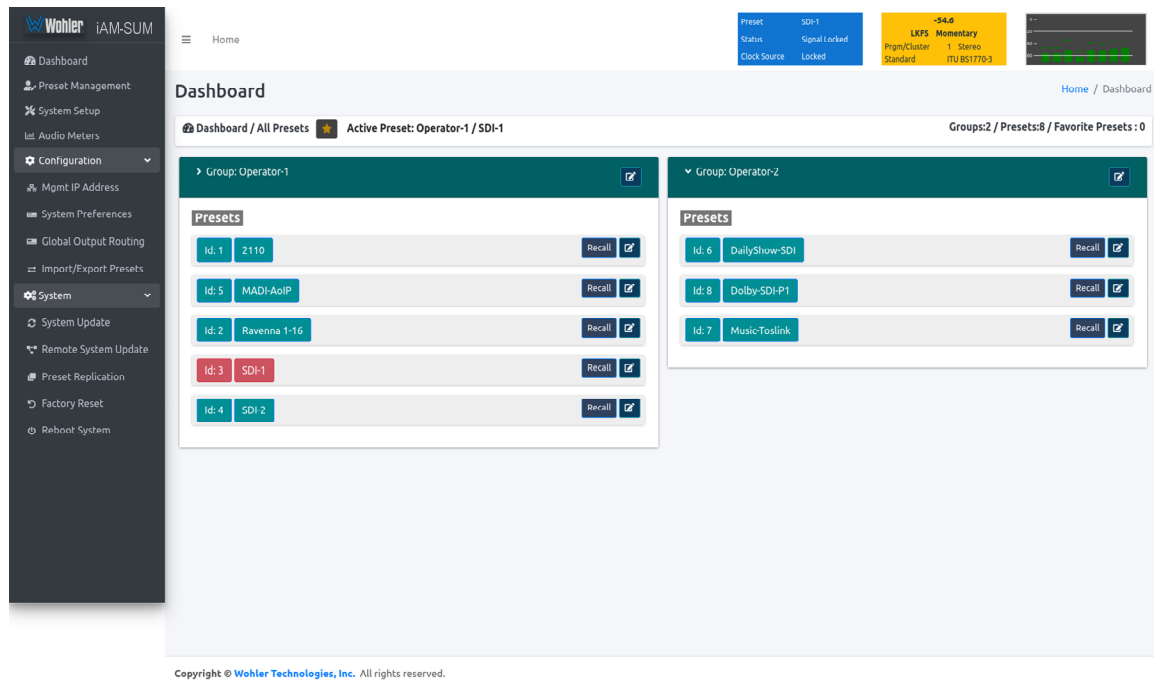

To view all of the Presets within a group, click on that group.

In Figure 4-4, it can be seen that there are five Presets in the Operator-1 group and no Presets in the Operator-2 group. The currently selected active Preset for local operation is shown in red. In Figure 4-4, this is the Preset named SDI-1.

Figure 4-4: Dashboard Preset Recall / Edit

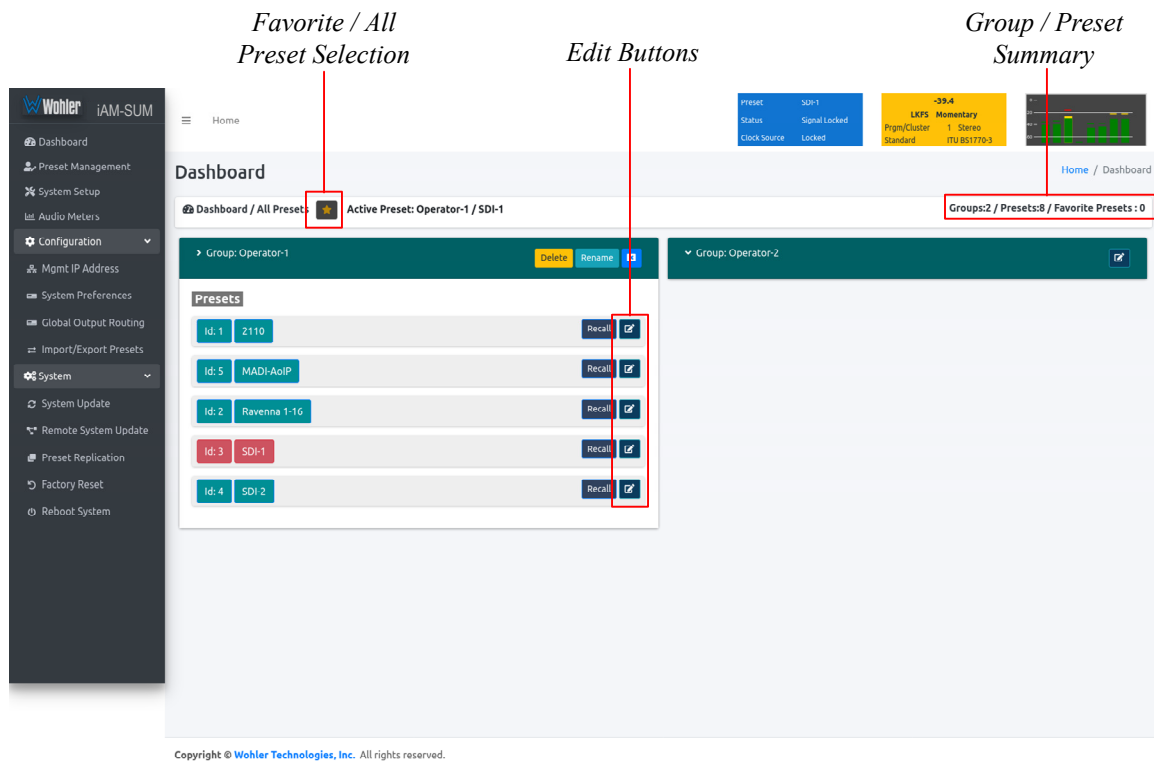

A Group / Preset Summary is shown in the upper right of the screen. This enables you to see the total number of Groups, Presets and Favorite Presets in the iAM-SUM.

Use the  button, as shown in Figure 4-4, to toggle between Favorite Presets or All Presets.

Click the **Recall** button to recall a Preset. To Edit a Preset, click the **Edit** icon, as shown in Figure 4-4, to the right of the associated **Recall** button.

After clicking the **Preset Edit** button, the screen shown in Figure 4-5 will appear. Clicking a **Group Edit** button will cause the screen in Figure 4-6 to appear.

Figure 4–5: Dashboard Preset Edit

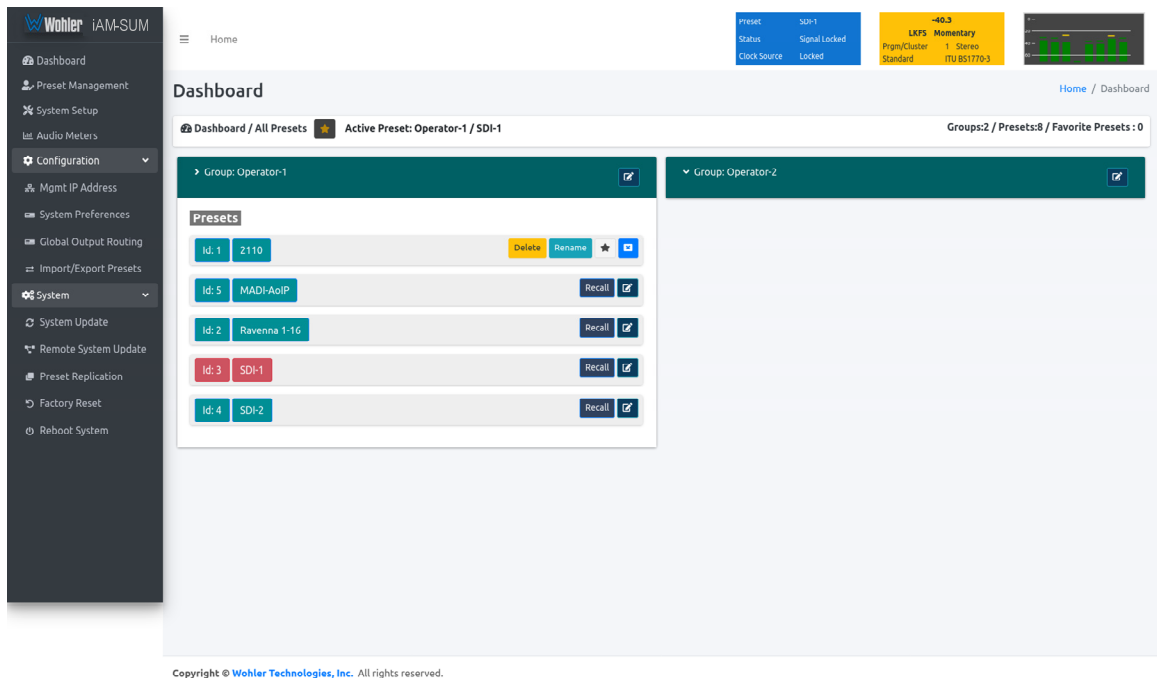

The Edit options for a Preset are:

1. Delete: Remove the Preset from the system. **Do Not delete the currently active Preset.**
2. Rename: Rename the Preset, but keep all of its other characteristics.
3. Make Favorite: Make this Preset a favorite. This can be done for frequently used Presets.

Figure 4–6: Dashboard Group Edit

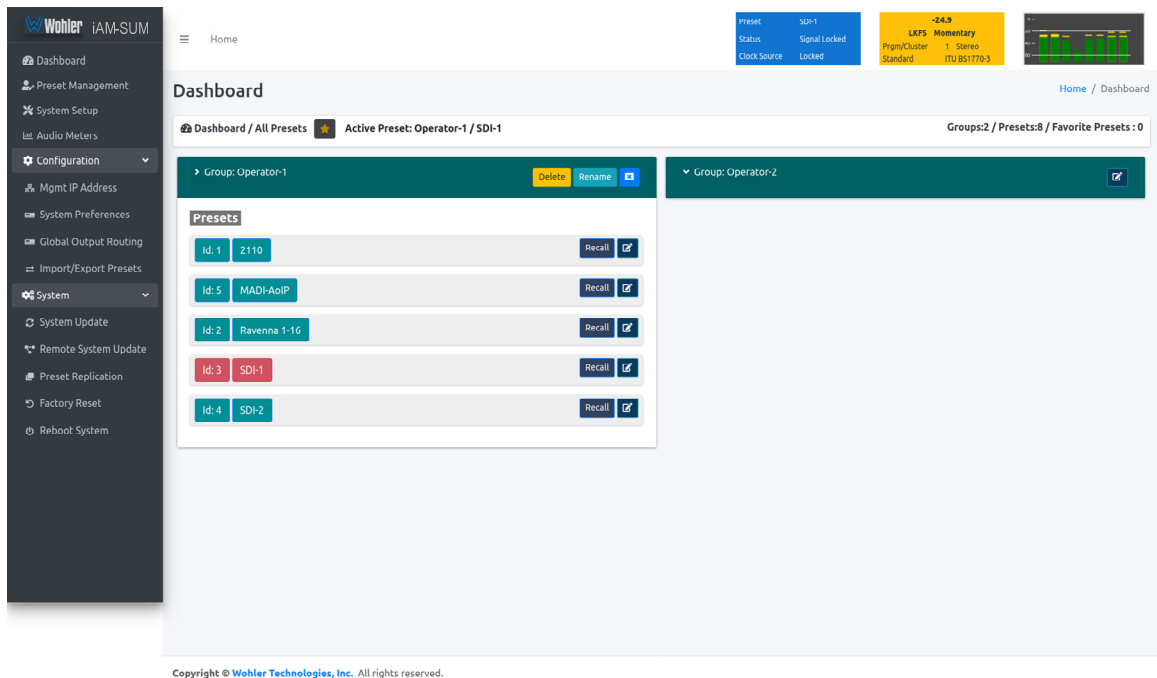

Copyright © Wohler Technologies, Inc. All rights reserved.

The Edit options for a Group are as follows:

1. Delete: Delete the Group and all of the Presets it contains.
2. Rename: Rename the Group, but keep all of its other characteristics.

Audio Meters

Click on **Audio Meters** to remotely display the audio meters of the *iAM-SUM*. This display is shown in Figure 4-7. Also displayed is the name of the source that the meters are displaying. In Figure 4-7, this is SDI/BNC-1.

Figure 4-7: Audio Meters Display



System Preferences

Click on **System Preferences** to find the System Audio Clock Reference, Loudness Configuration, and Phase Indicator Configuration tabs. These are as shown in Figures 4-8, 4-9, and 4-10.

System Audio Clock Reference

The System Audio Clock Reference setting provides a way to set the global clock source for the unit. This setting will be used whenever a source is selected using the **Source Select** knob or the **Source Select Menu**. If the System Audio Clock Reference is set to **None**, then the currently selected source acts as the Clock Reference. This tab is shown in Figure 4-8.

This System Audio Clock Reference setting can be overridden by the optional System Clock Reference setting in the Preset Management menu when the Preset is chosen.

Figure 4-8: System Audio Clock Reference Tab

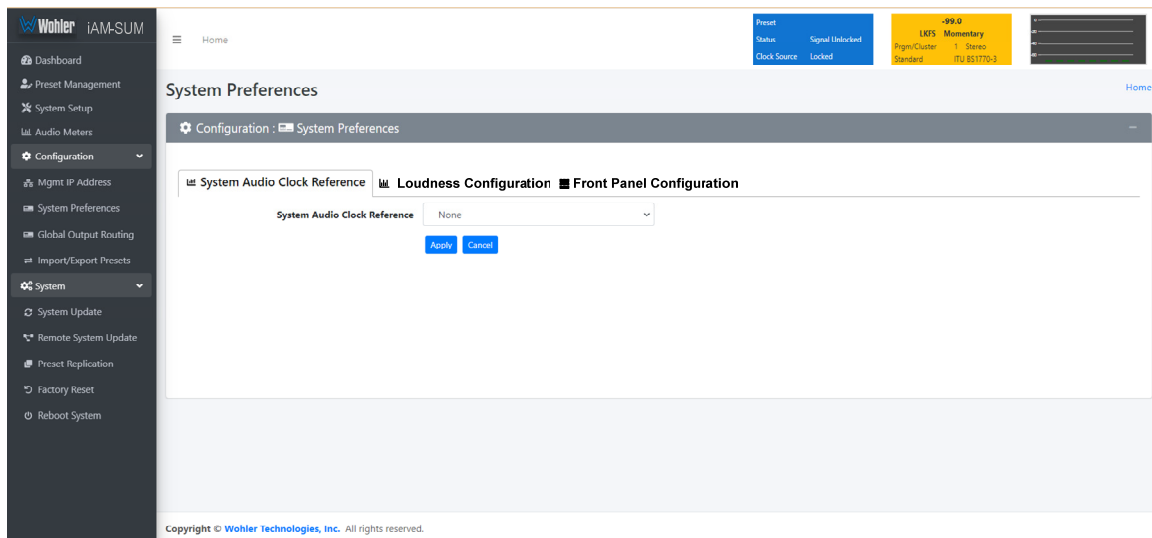

Loudness Configuration Tab

The Loudness Configuration tab allows you to make settings which will determine how Loudness is to be calculated on the Loudness Meter. This tab is shown in Figure 4-9.

Figure 4-9: Loudness Configuration Tab

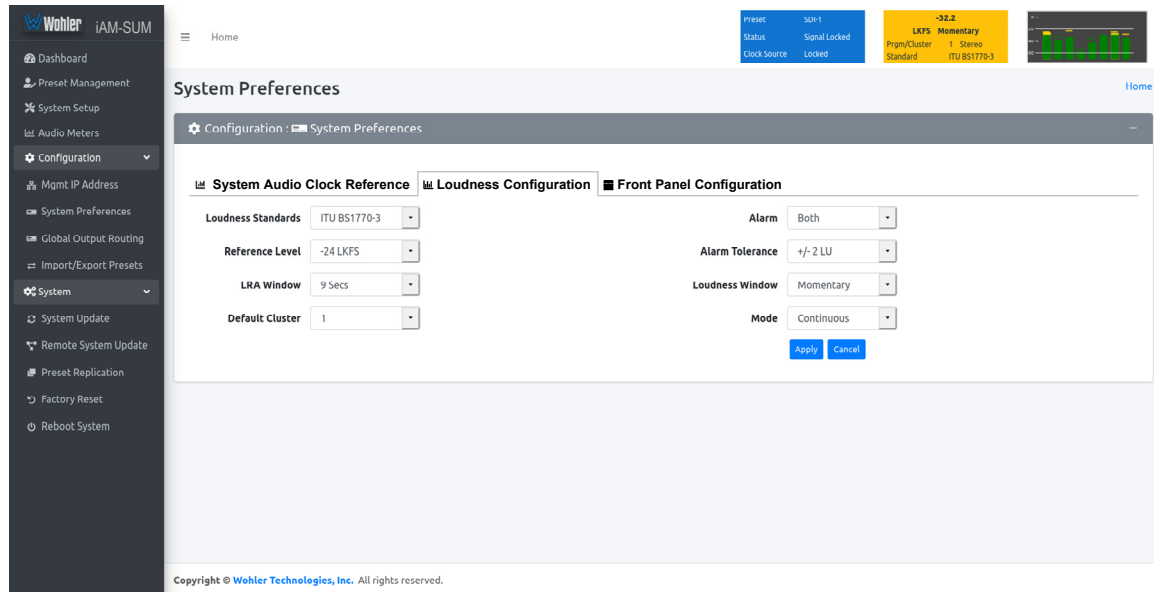

The following settings can be made on this tab:

1. **Loudness Standard:** This is the loudness standard by which the loudness calculation is made.
2. **Reference Level:** This is the set point in the loudness measurement about which the determination is made as to whether an alarm should be displayed.
3. **LRA Window:** This is a moving window of time over which the loudness measurement is made.
4. **Default Cluster:** When a Metering Screen is entered, this is the number of the cluster that will initially be monitored for Loudness.
5. **Alarm:**
 - a. **Over:** The Alarm indication will only appear when Loudness has exceeded the **Reference Level** by the **Tolerance** amount.
 - b. **Under:** The Alarm indication will only appear when Loudness is below the **Reference Level** by the **Tolerance** amount.
 - c. **Both:** The Alarm indication will only appear when Loudness has exceeded or is below the **Reference Level** by the **Tolerance** amount.
 - d. **Off:** The Alarm indication will not appear.
6. **Alarm Tolerance:** This is the range over which a normal loudness indication is given. Above or below this range will result in color changes in the graph.
7. **Loudness Window:** This may be set to **Momentary**, **Short**, or one of 22 values, ranging from one second to two hours.
8. **Monitoring Mode:**

- a. **Manual:** Touch the Manual button to enable Manual Mode. This allows you to measure the loudness of a specific program or segment of a program, such as a commercial. In this mode, the **Start** and **Stop** button on the Loudness Meter screen can be manually used to begin and end a loudness measurement interval. The reading for that interval is then held on the Loudness Meter.
- b. **Continuous:** Touch the **Continuous** button to enable Continuous Mode. In this mode, loudness readings are continually made. The **Stop** button on the Loudness Meter screen is not active.

Note: Further and more detailed descriptions of all of the above Loudness terms may be found in the ITU-R BS.1770-3 loudness standard.

When you have finished making the settings click **Apply** to save them or click **Cancel** to discard them.

Front Panel Configuration Tab

To prevent accidental or unauthorized changing of critical settings in the local product menus, it is possible to restrict access. The Front Panel Configuration Tab entry screen is shown in Figure 4-10. This provides an entryway to the Front Panel Configuration Tab shown in Figure 4-12. To proceed, you must enter the correct Passcode. If no Passcode has been set, the default Passcode is 0-0-0-0.

Figure 4-10: Front Panel Configuration Tab – Passcode Entry

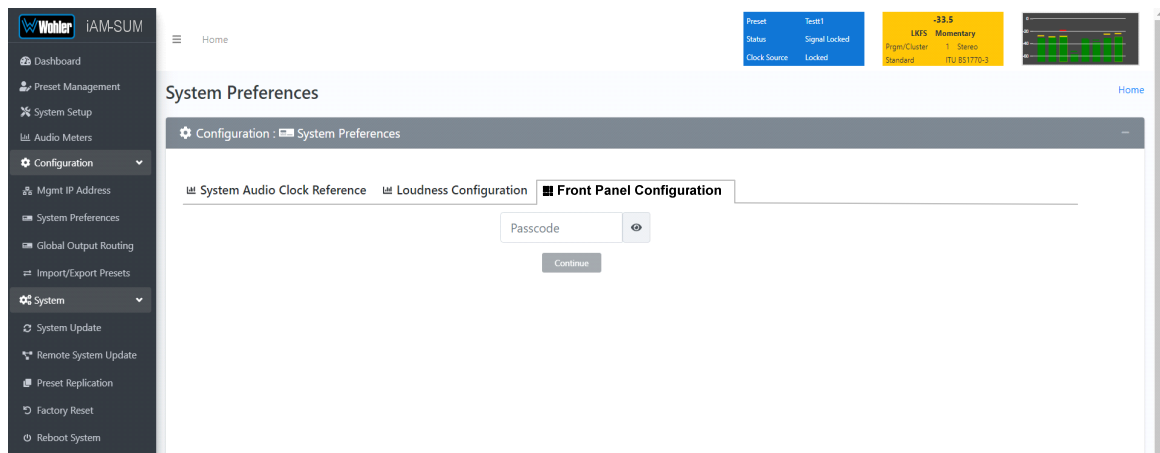

If an incorrect Passcode is entered, the screen shown in Figure 4-11 appears. Click the **Continue** button to try again. If you have forgotten the Passcode, this can be remedied by performing a Factory Reset. Unfortunately, this will also erase all of the menu settings. You may also contact Wohler Technical Service for help.

Figure 4-11: Unrecognized Passcode

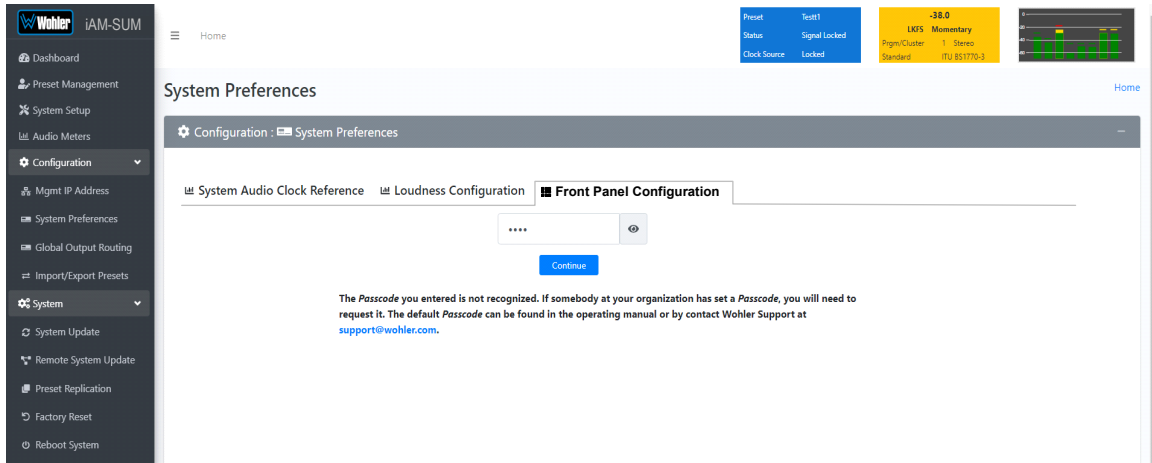

When you have successfully entered the Passcode, the Passcode Settings screen will appear, as shown in Figure 4-12.

Figure 4-12: Front Panel Configuration Tab

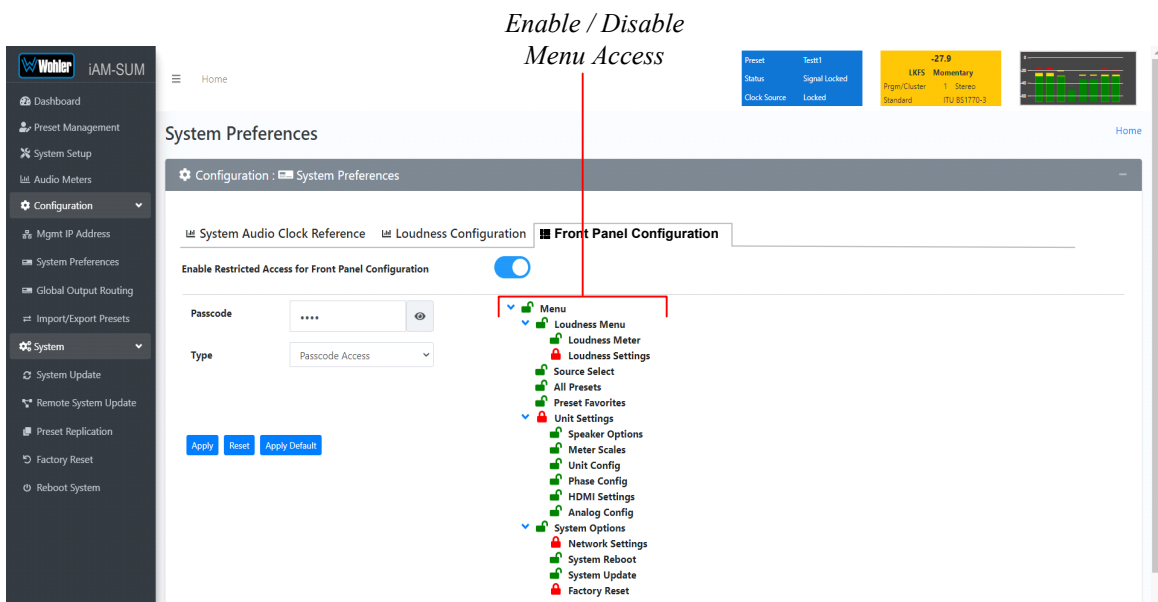

The functions on this screen are as follows:

Enable Restricted Access for Front Panel Configuration: This switch will turn ON or OFF protection or blocking of any local product menus, except for the Passcode Settings menu, which is always Passcode protected.

Passcode: You may enter a new Passcode in this field. The Passcode can be any 4-digit number. Be sure to save the Passcode in a safe place for future reference.

Type: Select the type of disabled button appearance on the local product menus using the **Type** button. The choices are:

Passcode Access: The Passcode protected function buttons include a small orange padlock icon within the buttons. This is shown in the left image of Figure 4-13. These buttons can only be accessed using the correct Passcode.

No Access: If the function buttons are protected by No Access, the buttons are grayed out and non-functional, as shown in the right side of Figure 4-13. These buttons cannot be accessed.

Apply Default: Clicking this button returns the settings in this screen to the factory default values. The Passcode becomes 0-0-0-0.

Reset: Clicking this button undoes any settings you have made on this tab.

Enable / Disable Menu Access: This section provides a nested chart of the local menus that exist in the product. You may set which menus are affected by restrictions. Click any menu shown to change it between affected (red icon) and unaffected (green icon).

Apply: When you have completed the desired settings in this tab, click **Apply** to put them into effect.

Figure 4-13: Examples of Local Menu Protection

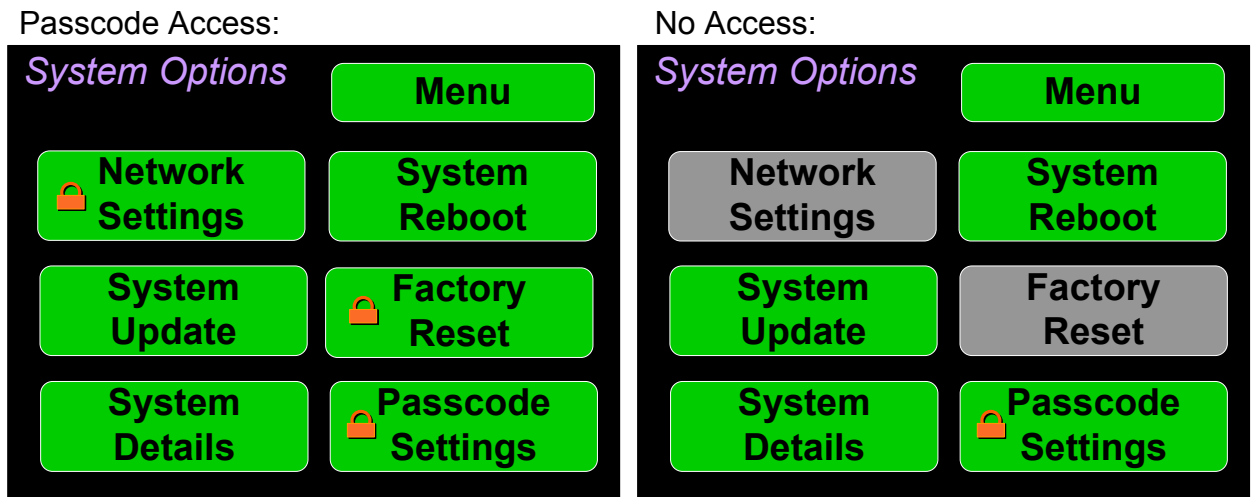

Preset Management

Presets are monitoring configurations that can be composed of channels from multiple sources and displayed on the meters in any order. Presets should be set up to allow operators to quickly shift between setups for monitoring. The **Preset Management** screen contains selections of all of the details for a Preset, and is largely arranged in a matrix format connecting input channels to monitoring channels. The screen is shown in Figure 4-14.

Figure 4-14: Configure Presets

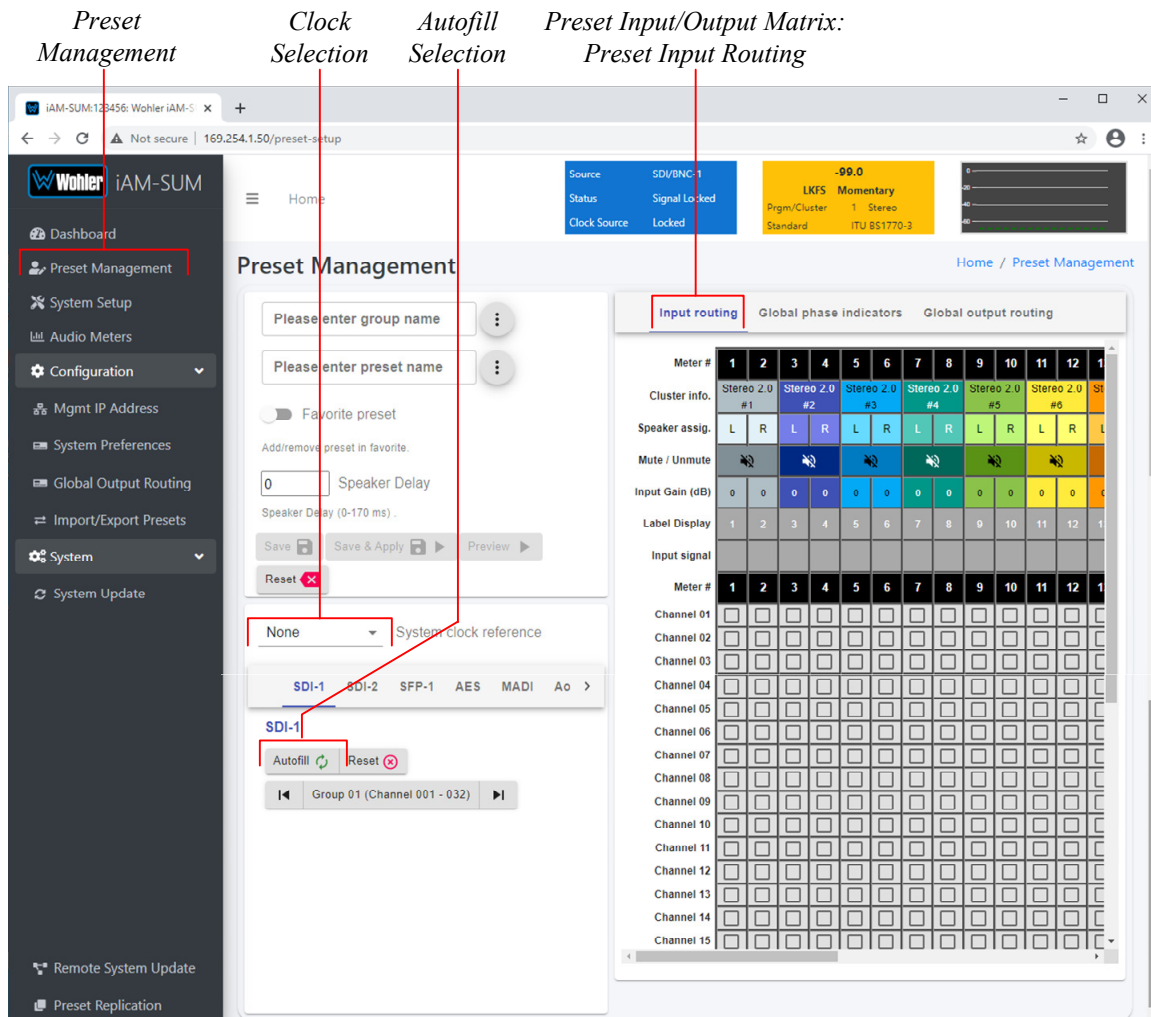

1. **Preset Configuration:** You may create a new Preset, adjust an existing Preset, or create a new Preset from an existing Preset:
 - **To create a new Preset,** enter the name for the new Preset in the field to the left of the word **Preset**. Then make all of the settings needed and save it.
 - **To make changes to an existing Preset,** select it from the pull down list, make the needed changes and save it.
 - **To create a new Preset starting with an existing Preset,** first select the existing Preset from the pull down list. Next, enter the name for the new Preset and save it. Then make the needed changes and

save it.

Presets may be created for any licensed inputs, even if the SFP module for an input is not plugged into its respective socket at the time. This makes it easy to swap SFP input modules without having to recreate presets after the insertion or removal of an SFP module. Note that if a licensed SFP module is not detected, such as when one is removed to be swapped, its monitoring inputs will be muted. Likewise, if the required license has not been entered for an SFP module that is inserted, its monitoring inputs will also be muted. Refer to the **Licenses** section in this chapter to install software licenses.

2. **System Clock Reference:** There must be a system clock reference for monitoring to take place. Select a reference from the pull down list. The best choice is a stable, always present clock source locked to house sync. Second to that, use the selected input as the clock. Generally speaking, **Internal** is not the best choice.
3. **Speaker Delay:** If desired, an audio delay may be inserted ahead of the monitor speakers. This delay may range from 0 to 170 mS. Typically, delay is used to align the monitored audio with a video monitored signal.
4. **Input Selection:** Audio from any of the input sources may be applied to the monitoring scheme in any way. For example, you may have 6 channels from an SDI stream, along with 2 AES channels, and along with 2 analog channels assigned your choice of meters. A **Preset Input/Output Matrix** is provided on the lower right side of the screen to allow you to assign each channel. Simply select each input source, one at a time, and then check the boxes in the **Matrix** to apply each input channel number to a metered channel number. They do not have to be applied in any specific order. The order of assignment should be chosen to make it easy for the operator to understand. If there are more than 8 channels in a source, the desired group of 8 can also be selected from the box in the lower left of the screen.
5. **Autofill Selection:** If you simply want to map all 8 input channels to all 8 meters in the same order, click the **Autofill** button. The **Preset Input/Output Matrix** will automatically fill out. To remove all mapping, click the **Reset** button that is adjacent to the **Autofill** button.
6. **Cluster Definition and Naming:** Channel Clusters are a series of channels that are all associated with monitoring the same signal. For example, a Stereo Cluster consists of two channels that together monitor a stereo signal. A Surround 5.1 Cluster consists of 6 channels that together monitor a 5.1 surround sound signal. Clicking a **Cluster Info** box opens a **Cluster** selection box.

In the **Cluster** box, you can select the type of Cluster from a pull down selection. The available **Cluster Type** selections are:

- Mono 1.0: The channel will appear within a single-channel cluster.
- Stereo 2.0: The channels will appear within a two-channel cluster.
- Surround 5.1: The channels will appear within a 6-channel cluster.
- Surround 7.1: The channels will appear within an 8-channel cluster.
- Custom: You may define a 0 to 8 channel cluster.

Multichannel clusters will expand to the right and overwrite any clusters on

overlapping meter positions.

By default, all odd numbered channels will map to the left speakers and all even numbered channels will map to the right speakers. You may change this using the crosspoint selections in the Input/Output Matrix.

A default name will be chosen and it will appear on the metering screen. You may name the Cluster anything you want by simply changing the words within the **Cluster Name** field.

When finished, click **Update**. To undo your change, click **Reset**. To undo all of the Cluster changes for the 8 channels, click **Reset All**. Click **X** to close the box.

7. **Speaker Assign:** Speaker assignments are made automatically when a cluster is set. However, it can be that in an actual signal, the channel assignments may be different than what the automatic assignment assumes. A speaker assignment adjustment is provided for each channel, should you need to override the automatic settings. **It is important to accurately assign the function of each channel so that the Loudness calculations will be accurate.** Clicking a **Speaker Assign** button on a channel opens a box that lets you change the current setting. Click **X** to close the box.
8. **Mute/Unmute:** A **Mute/Unmute** control is provided for each channel, although the adjustment will affect all channels in the Cluster. This allows the operator to just see the meters for certain channels and not hear the audio. This is an alternate action control.
9. **Input Gain (dB):** The Input Gain Trim of each input channel may be adjusted from -60dB to +12dB. The default setting is 0dB. The Input Trims may also be adjusted from the controls on the front panel of the iAM-MIX and these changes will appear on this screen.
10. **Label Display:** The default Label Display on each channel on the iAM-MIX screen is the consecutive number of each channel's appearance on the display. It may be changed on this screen within the limits of the space for it on the iAM-MIX screen.
11. The **Output Routing** tab is shown in Figure 4-15 when the OPT-OUTPUT-ROUTING capability was not purchased and licensed. This tab shows how signals from the inputs are routed to the outputs. It allows you to view, but not change this default routing.

Figure 4-15: Default Output Routing

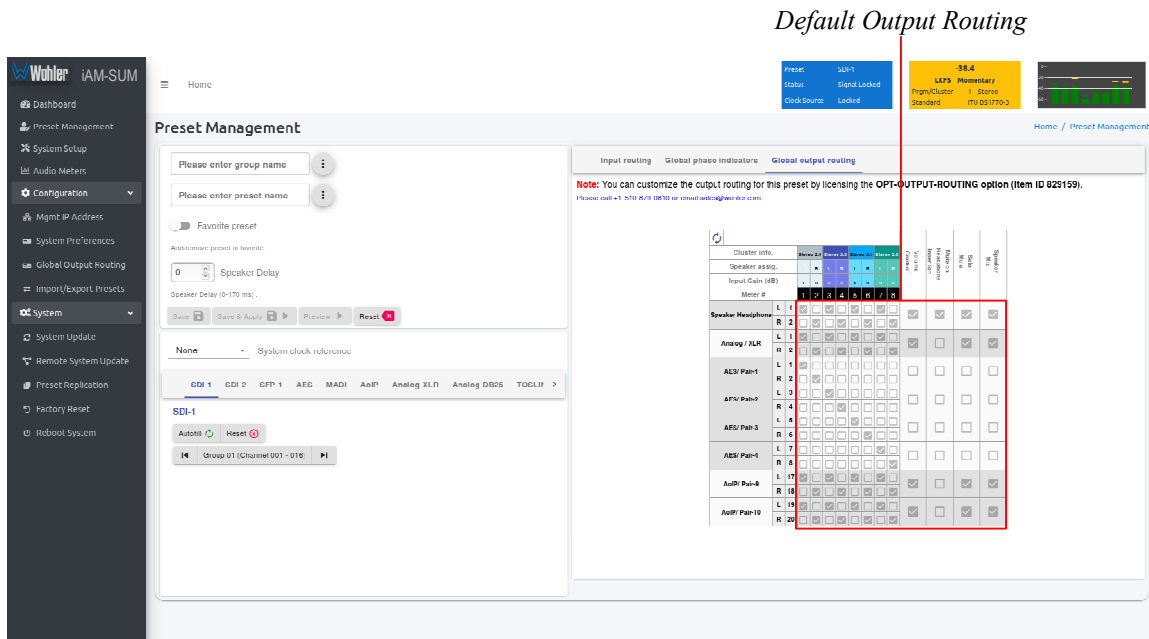

However, if the OPT-OUTPUT-ROUTING license is installed, this tab allows you to determine exactly which input channels are routed to which outputs. It then appears as shown in Figure 4-16. This very flexible capability allows you to route signals according to Preset or as a default for the whole system. Refer to the **Global Output Routing** section in this chapter to learn the function of each of the checkboxes and of the matrix in this tab.

To set up a different input to output routing scheme for the Preset you are creating, click the **Global Output Routing** tab and uncheck the **Apply Global Output Routing** checkbox. You may then adjust the output routing as you desire on this tab and it will only apply to this Preset.

Figure 4-16: Output Routing Preset Tab

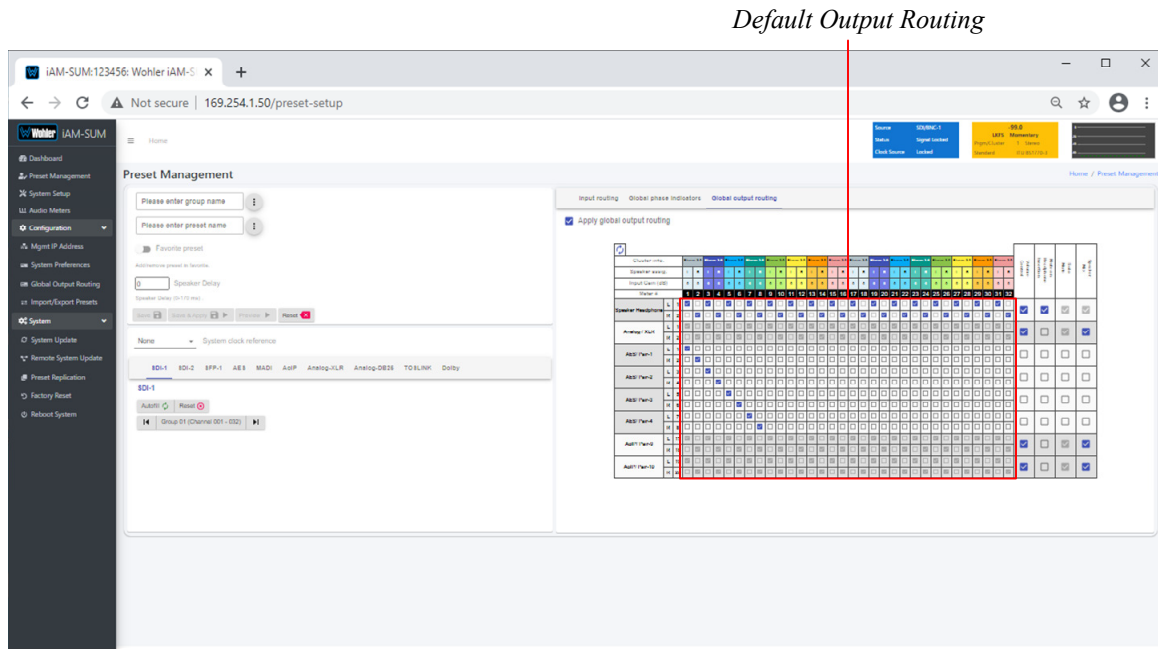

12. When you have finished creating a Preset or making changes to a Preset, either click the **Save** button to save the Preset, click the **Save & Apply** button to save the Preset and make it the current Preset, or click the **Reset** button to discard the changes just made. These selections are shown in Figure 4-16.

Output Routing

The **Output Routing** licensed feature (OPT-OUTPUT-ROUTING) allows channels to be routed or combined and routed in custom ways to various destination outputs. **Output Routing** is applied to:

1. Signals monitored using "Input Source select" from the Front Panel,
2. Presets that have been created to apply the Output Routing.

Any change to the routing will affect the Presets that have "Apply Output Routing" selected. For example, multiple channels of a 7.1 channel program can be combined and directed to the left or right internal speakers. Six or eight channels could be directed to the AES outputs, which could feed an external surround sound system. Contact Wohler Sales to purchase the license for the OPT-OUTPUT-ROUTING feature.

If **Output Routing** is not licensed, then any of the inputs can be monitored in stereo or mono only through the internal speakers. The headphone jack, the analog XLR outputs, and the first AES output will follow whatever is directed to the speakers.

When licensed, select **Global Output Routing** under **Configuration**. This will display the **Global Output Routing** screen. This screen contains a matrix of checkboxes which are an easy way for you to set up the wide variety of input to output routing and mixing capabilities. The **Global Output Routing** screen is

shown in Figure 4-17.

Figure 4-17: Global Output Routing Option

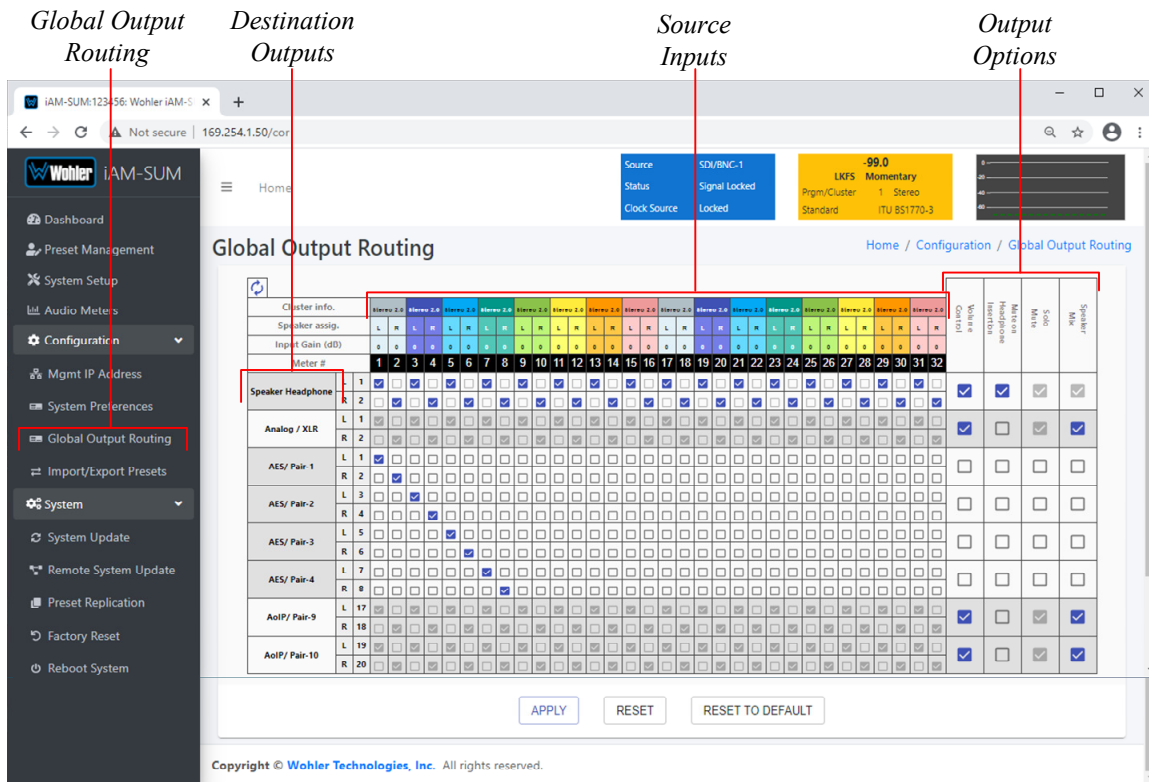

Destination Outputs

On the left of the **Global Output Routing** screen are listed the Destination Outputs. These are the outputs to which any input can be routed. They are as follows:

1. **Speaker/Headphone:** Selected inputs will be sent to the left and right speakers. The default routing is set as per the Speaker Assignment, left channels are sent to the left speaker and right channels are sent to Right speaker.
2. **Analog XLR:** Selected inputs will be mixed to the left and right channels and played through the two Analog XLR Outputs.
3. **AES/Pair-1:** Selected inputs will be mixed to the left and right channels and played through the AES Pair 1 Output.
4. **AES/Pair-2:** Selected inputs will be mixed to the left and right channels and played through the AES Pair 2 Output.
5. **AES/Pair-3:** Selected inputs will be mixed to the left and right channels and played through the AES Pair 3 Output.
6. **AES/Pair-4:** Selected inputs will be mixed to the left and right channels and played through the AES Pair 4 Output. The four AES outputs can be used together to output, for example, 5.1 or 7.1 surround channels to an external surround sound monitor system.

7. **AoIP/Pair-9 (DANTE / RAVENNA)**: Selected inputs will be mixed to AoIP transmit channels 17 and 18. Note that configuration for channels 1 – 16 is not supported. Use a Dante Controller or Anneman/Zman web interface to route these channels appropriately.
8. **AoIP/Pair-10 (DANTE / RAVENNA)**: Selected inputs will be mixed to Channel 19 and Channel 20. Use a Dante Controller or Anneman/Zman web interface to route the remaining pairs appropriately.

Source Inputs

The source inputs which may be routed are described in this section.

1. **Cluster Information**: Cluster information show type of cluster and cluster name.
2. **Speaker Assignment**: Speaker assignment can be used to configure to which speakers the audio is routed to. The possible options are:
 - L** Left
 - R** Right
 - C** Center
 - LFE** Low Frequency Effects
 - Ls** Left Surround
 - Rs** Right Surround
 - Bsl** Back Surround Left
 - Bsr** Back Surround Right
 - S** Mono Surround
3. **Input/Output Matrix**: By checking the various boxes in this matrix, any input channels can be freely routed to any output channels. This flexible channel assignment is called a **Free Mix**. However, when the **Speaker Mix** box is checked in the **Output Options** section, the associated row within the matrix is automatically set to the speaker mix and the checkboxes are grayed out indicating that you may not change them with a **Free Mix** assignment.

Output Options

The optional settings in this section allow for customization.

1. **Speaker Mix**: This option selects whether an output has the **Speaker Mix** or a **Free Mix** as set in the Routing Input section. The Speaker/Headphone output is always in the **Speaker Mix**.
2. **Solo/Mute**: This setting determines whether or not the outputs are affected by solos and mutes. The Speaker/Headphone output is always affected by solos and mutes. Note also, that all outputs in **Speaker Mix** mode also are affected by solos and mutes.
3. **Mute on Headphone Insertion**: This option controls whether the outputs should be muted upon a headphone insertion. This setting can be adjusted

even for outputs whether they are in **Speaker Mix** or **Free Mix** modes.

4. **Volume Control:** This setting determines whether each output pair is adjusted by the **Volume Control** knob. Speaker/Headphone outputs are always affected by the volume control knob, as are any outputs that are in **Speaker Mix** mode.

Typical Questions Regarding Output Routing

The questions and thoughts in this section are commonly asked by people when setting up the licensed Output Routing capability.

What signal outputs can be controlled using the Output Routing feature?

All the outputs on the *iAM-SUM* can be controlled using the Output Routing feature. This includes – Internal Speakers, Analog XLR outputs, all 4 pairs of AES outputs on HD-15, and AoIP Pair 9 and Pair 10.

How do the outputs behave if I do not purchase OPT-OUTPUT-ROUTING license?

If Output routing license is not purchased, the outputs are configured as follows:

1. **Speakers:** All monitored channels are always available on the internal speakers. The left and right speaker assignment is determined by the **Speaker Assignment**. Audio on the speakers is controlled by the **Volume** and **Balance** knobs and is muted whenever a headphone is inserted into the **Headphone** jack.
2. **Analog XLRs:** These outputs follow the same configuration as the internal speakers. They are controlled by the **Volume** and **Balance** knobs and are muted whenever a headphone is inserted into the **Headphone** jack. These outputs also follow the solo/mute selections on the Audio Meter screen.
3. **AES Pairs 1 through 4:** The first 8 channels appear on these outputs in numeric order. They are pre-fade, so they are unaffected by the **Volume** and **Balance** knobs or headphone insertion. They are also unaffected by the solo/mute selections on the Audio Meter screen.
4. **AoIP Pairs 9 and 10:** These outputs follow the same configuration as the internal speakers. They are controlled by the **Volume** and **Balance** knobs and are muted whenever a headphone is inserted into the **Headphone** jack. These outputs also follow the solo/mute selections on the Audio Meter screen.

What is the difference between Global Output Routing and Output Routing in Presets?

Both are used to configure the unit outputs. Global Output Routing is applied by default when you select a source or when creating presets and when you don't

change the Output Routing unique to any Preset. Changes to either of these are disabled if the OPT-OUTPUT-ROUTING license is not purchased.

How do I route whatever is being monitored to the XLR and AES outputs?

Using **Global Output Routing** (optional licensing upgrade), you may route any signals to the XLR & AES outputs. You may route signals to the XLR outputs using the **Analog/XLR** checkboxes and route signals to the AES outputs by using the **AES/Pair 1 to Pair 4** checkboxes.

Analog / XLR	L 1	<input type="checkbox"/>	<input type="checkbox"/>	<input type="checkbox"/>	<input checked="" type="checkbox"/>	<input checked="" type="checkbox"/>	<input type="checkbox"/>	<input checked="" type="checkbox"/>	<input checked="" type="checkbox"/>	<input checked="" type="checkbox"/>	<input checked="" type="checkbox"/>	<input checked="" type="checkbox"/>	<input type="checkbox"/>
	R 2	<input type="checkbox"/>	<input type="checkbox"/>	<input type="checkbox"/>	<input checked="" type="checkbox"/>	<input checked="" type="checkbox"/>	<input type="checkbox"/>	<input checked="" type="checkbox"/>	<input checked="" type="checkbox"/>	<input checked="" type="checkbox"/>	<input checked="" type="checkbox"/>	<input checked="" type="checkbox"/>	<input type="checkbox"/>
AES/ Pair-1	L 1	<input checked="" type="checkbox"/>	<input checked="" type="checkbox"/>	<input type="checkbox"/>	<input type="checkbox"/>	<input type="checkbox"/>	<input type="checkbox"/>	<input type="checkbox"/>	<input type="checkbox"/>	<input type="checkbox"/>	<input type="checkbox"/>	<input type="checkbox"/>	<input type="checkbox"/>
	R 2	<input type="checkbox"/>	<input checked="" type="checkbox"/>	<input checked="" type="checkbox"/>	<input type="checkbox"/>	<input type="checkbox"/>	<input type="checkbox"/>	<input type="checkbox"/>	<input type="checkbox"/>	<input type="checkbox"/>	<input type="checkbox"/>	<input type="checkbox"/>	<input type="checkbox"/>

As shown in the above example, signals appearing on Audio Meter channels 1 through 4 are routed to AES Pair 1 and signals from Audio Meter channels 5 to 8 are routed to the Analog XLR outputs.

How do I have a downmixed pre-fade output on AES Pair-1 combined with a post-fade output on the Analog XLRs?

To downmix a pre-fade output on AES Pair-1, uncheck the **Volume Control** checkbox for that AES pair. For a Post-fade output on the Analog XLRs, check **Volume Control** checkbox.

Cluster info.		Stereo 2.0		Stereo 2.0		Stereo 2.0		Stereo 2.0		Volume Control
Speaker assign.		L	R	L	R	L	R	L	R	
Meter #		1	2	3	4	5	6	7	8	
Speaker Headphone	L 1	<input checked="" type="checkbox"/>	<input type="checkbox"/>	<input checked="" type="checkbox"/>	<input type="checkbox"/>	<input checked="" type="checkbox"/>	<input type="checkbox"/>	<input checked="" type="checkbox"/>	<input type="checkbox"/>	<input checked="" type="checkbox"/>
	R 2	<input type="checkbox"/>	<input checked="" type="checkbox"/>	<input type="checkbox"/>	<input checked="" type="checkbox"/>	<input type="checkbox"/>	<input checked="" type="checkbox"/>	<input type="checkbox"/>	<input checked="" type="checkbox"/>	<input checked="" type="checkbox"/>
Analog / XLR	L 1	<input type="checkbox"/>	<input type="checkbox"/>	<input type="checkbox"/>	<input type="checkbox"/>	<input type="checkbox"/>	<input type="checkbox"/>	<input type="checkbox"/>	<input type="checkbox"/>	<input checked="" type="checkbox"/>
	R 2	<input type="checkbox"/>	<input type="checkbox"/>	<input type="checkbox"/>	<input type="checkbox"/>	<input type="checkbox"/>	<input type="checkbox"/>	<input type="checkbox"/>	<input type="checkbox"/>	<input checked="" type="checkbox"/>
AES/ Pair-1	L 1	<input checked="" type="checkbox"/>	<input checked="" type="checkbox"/>	<input type="checkbox"/>	<input checked="" type="checkbox"/>	<input checked="" type="checkbox"/>	<input type="checkbox"/>	<input checked="" type="checkbox"/>	<input type="checkbox"/>	<input type="checkbox"/>
	R 2	<input type="checkbox"/>	<input checked="" type="checkbox"/>	<input type="checkbox"/>	<input checked="" type="checkbox"/>	<input type="checkbox"/>	<input checked="" type="checkbox"/>	<input type="checkbox"/>	<input checked="" type="checkbox"/>	<input type="checkbox"/>

Volume Control:
On - Post-fade
Off - Pre-fade

How do I make the XLR outputs follow the Audio Meter screen solos & mutes while the AES Pair-1 does not?

Make the settings shown in the **Solo / Mute** column:

Solo Mute:
On - Outputs follow user Solo/Mute
Off - Outputs do not follow user Solo/Mutes

Cluster info.		Stereo 2.0		Stereo 3.0		Stereo 2.0		Stereo 3.0		Volume Control	Insertion	Mute on Headphone	Solo Mute
Speaker assign.	Meter #	L	R	L	R	L	R	L	R				
Speaker Headphone	L 1	<input checked="" type="checkbox"/>	<input type="checkbox"/>	<input checked="" type="checkbox"/>	<input type="checkbox"/>	<input checked="" type="checkbox"/>	<input type="checkbox"/>	<input checked="" type="checkbox"/>	<input type="checkbox"/>	<input checked="" type="checkbox"/>	<input checked="" type="checkbox"/>	<input checked="" type="checkbox"/>	<input checked="" type="checkbox"/>
	R 2	<input type="checkbox"/>	<input checked="" type="checkbox"/>	<input type="checkbox"/>	<input checked="" type="checkbox"/>	<input type="checkbox"/>	<input checked="" type="checkbox"/>	<input type="checkbox"/>	<input checked="" type="checkbox"/>	<input type="checkbox"/>	<input checked="" type="checkbox"/>	<input type="checkbox"/>	<input type="checkbox"/>
Analog / XLR	L 1	<input type="checkbox"/>	<input type="checkbox"/>	<input type="checkbox"/>	<input type="checkbox"/>	<input type="checkbox"/>	<input type="checkbox"/>	<input type="checkbox"/>	<input type="checkbox"/>	<input checked="" type="checkbox"/>	<input type="checkbox"/>	<input checked="" type="checkbox"/>	<input type="checkbox"/>
	R 2	<input type="checkbox"/>	<input type="checkbox"/>	<input type="checkbox"/>	<input type="checkbox"/>	<input type="checkbox"/>	<input type="checkbox"/>	<input type="checkbox"/>	<input type="checkbox"/>	<input type="checkbox"/>	<input type="checkbox"/>	<input type="checkbox"/>	<input type="checkbox"/>
AES/ Pair-1	L 1	<input checked="" type="checkbox"/>	<input type="checkbox"/>	<input checked="" type="checkbox"/>	<input type="checkbox"/>	<input checked="" type="checkbox"/>	<input type="checkbox"/>	<input checked="" type="checkbox"/>	<input type="checkbox"/>	<input type="checkbox"/>	<input type="checkbox"/>	<input type="checkbox"/>	<input type="checkbox"/>
	R 2	<input type="checkbox"/>	<input checked="" type="checkbox"/>	<input type="checkbox"/>	<input checked="" type="checkbox"/>	<input type="checkbox"/>	<input checked="" type="checkbox"/>	<input type="checkbox"/>	<input checked="" type="checkbox"/>	<input type="checkbox"/>	<input type="checkbox"/>	<input type="checkbox"/>	<input type="checkbox"/>

The setting shown above determines that outputs will follow the Audio Meter screen solos & mutes for the XLR outputs because the checkbox is checked. It is not checked for the AES outputs, so they will not be affected by the solo & mute choices. This feature requires the optional OPT-OUTPUT-ROUTING output routing license.

How do I route only specific monitored channels to the Analog XLR outputs?

When the optional OPT-OUTPUT-ROUTING license is purchased, you may route specific channels as shown below. Here Audio Meter channels 1, 3, 5, and 7 are routed to the left analog XLR output and Audio Meter channels 2, 4, 6, and 8 are routed to the right analog XLR output. Unchecked channels are not routed. Make sure the **Speaker Mix** selection is turned off to enable this selection.

Analog / XLR		L 1	L 2	L 3	L 4	L 5	L 6	L 7	L 8	R 1	R 2	R 3	R 4	R 5	R 6	R 7	R 8
L 1		<input checked="" type="checkbox"/>	<input type="checkbox"/>	<input checked="" type="checkbox"/>	<input type="checkbox"/>	<input checked="" type="checkbox"/>	<input type="checkbox"/>	<input checked="" type="checkbox"/>	<input type="checkbox"/>	<input type="checkbox"/>	<input type="checkbox"/>	<input type="checkbox"/>	<input type="checkbox"/>	<input type="checkbox"/>	<input type="checkbox"/>	<input type="checkbox"/>	<input type="checkbox"/>
R 2		<input type="checkbox"/>	<input checked="" type="checkbox"/>	<input type="checkbox"/>	<input checked="" type="checkbox"/>	<input type="checkbox"/>	<input checked="" type="checkbox"/>	<input type="checkbox"/>	<input checked="" type="checkbox"/>	<input type="checkbox"/>	<input type="checkbox"/>	<input type="checkbox"/>	<input type="checkbox"/>	<input type="checkbox"/>	<input type="checkbox"/>	<input type="checkbox"/>	<input type="checkbox"/>

The optional Global Output Routing feature works great. But what if we don't want to create any Presets and want to monitor audio only using Source Select? How would I configure different outputs for Source Select choices?

Use the **Global Output Routing** settings to determine how the outputs are configured for source select options.

The **Global Output Routing** feature allows channels to be routed or combined and routed to various destinations. For example, channels 1 to 8 can be routed to AES outputs:

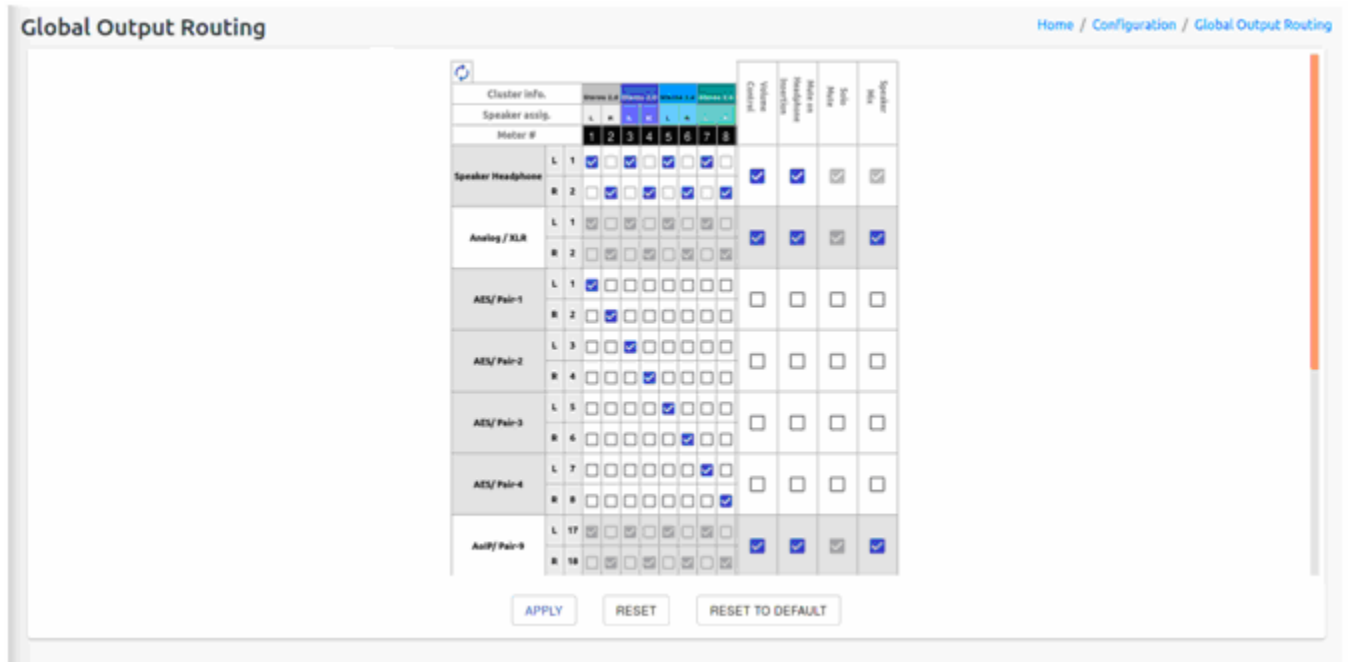

How do I keep the internal speakers muted and have audio only on the analog XLR outputs?

When the optional OPT-OUTPUT-ROUTING license is purchased, in the **Global Output Routing** configuration, do not select any **Speaker Headphone** checkboxes for any meter channels as shown below, and then select the desired meters for Analog XLR. In this way, the internal speakers will always be muted, but the audio will appear on the Analog XLR outputs (for amplified external speakers). Make sure that the **Speaker Mix** checkbox selection is unchecked for Analog/XLR.

Cluster info.		Meter 1	Meter 2	Meter 3	Meter 4	Meter 5	Meter 6	Meter 7	Meter 8	Volume Control	Mute on Headphone Insertion	Solo Mute	Speaker Mix
Speaker assign.		L	R	L	R	L	R	L	R				
Meter #		1	2	3	4	5	6	7	8				
Speaker Headphone	L	<input checked="" type="checkbox"/>	<input checked="" type="checkbox"/>	<input checked="" type="checkbox"/>	<input checked="" type="checkbox"/>	<input checked="" type="checkbox"/>	<input checked="" type="checkbox"/>	<input checked="" type="checkbox"/>	<input checked="" type="checkbox"/>	<input checked="" type="checkbox"/>	<input checked="" type="checkbox"/>	<input checked="" type="checkbox"/>	<input checked="" type="checkbox"/>
	R	<input checked="" type="checkbox"/>	<input checked="" type="checkbox"/>	<input checked="" type="checkbox"/>	<input checked="" type="checkbox"/>	<input checked="" type="checkbox"/>	<input checked="" type="checkbox"/>	<input checked="" type="checkbox"/>	<input checked="" type="checkbox"/>	<input checked="" type="checkbox"/>	<input checked="" type="checkbox"/>	<input checked="" type="checkbox"/>	<input checked="" type="checkbox"/>
Analog / XLR	L	<input checked="" type="checkbox"/>	<input checked="" type="checkbox"/>	<input checked="" type="checkbox"/>	<input checked="" type="checkbox"/>	<input checked="" type="checkbox"/>	<input checked="" type="checkbox"/>	<input checked="" type="checkbox"/>	<input checked="" type="checkbox"/>	<input checked="" type="checkbox"/>	<input checked="" type="checkbox"/>	<input checked="" type="checkbox"/>	<input type="checkbox"/>
	R	<input checked="" type="checkbox"/>	<input checked="" type="checkbox"/>	<input checked="" type="checkbox"/>	<input checked="" type="checkbox"/>	<input checked="" type="checkbox"/>	<input checked="" type="checkbox"/>	<input checked="" type="checkbox"/>	<input checked="" type="checkbox"/>	<input checked="" type="checkbox"/>	<input checked="" type="checkbox"/>	<input checked="" type="checkbox"/>	<input type="checkbox"/>

How do I ensure that the outputs are automatically muted when the Headphone jack is inserted?

When the optional OPT-OUTPUT-ROUTING license is purchased, in the **Global Output Routing** configuration, if the **Mute on Headphone Insertion** checkbox is ON then the outputs get automatically muted when a headphone is inserted into the Headphone jack.

As shown below, if a headphone is inserted then the output on the Analog XLRs will be muted, while the audio on AES Pair 1 will remain on.

Mute on Headphone Insertion:
On: Outputs are muted when Headphone Jack is inserted
Off: Outputs are not muted when Headphone Jack is inserted.

Cluster info.		Stereo 2.0		Stereo 2.0		Stereo 2.0		Stereo 2.0		Volume Control	Mute on Headphone Insertion	Solo Mute	Speaker Mix
Speaker assig.		L	R	L	R	L	R	L	R				
Meter #		1	2	3	4	5	6	7	8				
Speaker Headphone	L 1	<input type="checkbox"/>	<input type="checkbox"/>	<input type="checkbox"/>	<input type="checkbox"/>	<input type="checkbox"/>	<input type="checkbox"/>	<input type="checkbox"/>	<input type="checkbox"/>	<input checked="" type="checkbox"/>	<input checked="" type="checkbox"/>	<input checked="" type="checkbox"/>	<input checked="" type="checkbox"/>
	R 2	<input type="checkbox"/>	<input type="checkbox"/>	<input type="checkbox"/>	<input type="checkbox"/>	<input type="checkbox"/>	<input type="checkbox"/>	<input type="checkbox"/>	<input type="checkbox"/>	<input checked="" type="checkbox"/>	<input checked="" type="checkbox"/>	<input checked="" type="checkbox"/>	<input checked="" type="checkbox"/>
Analog / XLR	L 1	<input checked="" type="checkbox"/>	<input type="checkbox"/>	<input checked="" type="checkbox"/>	<input type="checkbox"/>	<input checked="" type="checkbox"/>	<input type="checkbox"/>	<input checked="" type="checkbox"/>	<input type="checkbox"/>	<input type="checkbox"/>	<input checked="" type="checkbox"/>	<input type="checkbox"/>	<input type="checkbox"/>
	R 2	<input type="checkbox"/>	<input checked="" type="checkbox"/>	<input type="checkbox"/>	<input checked="" type="checkbox"/>	<input type="checkbox"/>	<input checked="" type="checkbox"/>	<input type="checkbox"/>	<input checked="" type="checkbox"/>	<input type="checkbox"/>	<input checked="" type="checkbox"/>	<input type="checkbox"/>	<input type="checkbox"/>
AES/ Pair-1	L 1	<input checked="" type="checkbox"/>	<input type="checkbox"/>	<input type="checkbox"/>	<input type="checkbox"/>	<input type="checkbox"/>	<input type="checkbox"/>	<input type="checkbox"/>	<input type="checkbox"/>	<input type="checkbox"/>	<input type="checkbox"/>	<input type="checkbox"/>	<input type="checkbox"/>
	R 2	<input type="checkbox"/>	<input checked="" type="checkbox"/>	<input type="checkbox"/>	<input type="checkbox"/>	<input type="checkbox"/>	<input type="checkbox"/>	<input type="checkbox"/>	<input type="checkbox"/>	<input type="checkbox"/>	<input type="checkbox"/>	<input type="checkbox"/>	<input type="checkbox"/>

What are AoIP-Pair 9 and AoIP Pair 10?

AoIP-Pair 9: Selected inputs will be mixed to AoIP transmit channels 17 and 18. Note that configuration for channels 1 - 16 is not supported. Use a Dante Controller or Zman web interface to route these channels appropriately.

AoIP-Pair 10: Selected inputs will be mixed to Channel 19 and Channel 20. Again, use a Dante Controller or Zman web interface to route the remaining pairs appropriately.

How do I ensure that my outputs are pre-faded but follow the solo-mutes on the web interface? This will allow us to monitor only the unmuted/solo Audio Meter channels on amplified stereo speakers connected to the Analog XLR's.

In the **Output Routing** setting, for the Analog XLR outputs, keep the **Volume Control** checkbox unchecked and the **Solo/Mute** checkbox checked. This ensures that the Volume Control is **not** applied to the outputs, while the Solos/Mutes **are**.

Cluster info.		Stereo 2.0		Stereo 2.0		Stereo 2.0		Stereo 2.0		Volume Control	Mute on Headphone Insertion	Solo Mute	Speaker Mix
Speaker assig.		L	R	L	R	L	R	L	R				
Meter #		1	2	3	4	5	6	7	8				
Speaker Headphone	L 1	<input type="checkbox"/>	<input type="checkbox"/>	<input type="checkbox"/>	<input type="checkbox"/>	<input type="checkbox"/>	<input type="checkbox"/>	<input type="checkbox"/>	<input type="checkbox"/>	<input checked="" type="checkbox"/>	<input checked="" type="checkbox"/>	<input checked="" type="checkbox"/>	<input checked="" type="checkbox"/>
	R 2	<input type="checkbox"/>	<input type="checkbox"/>	<input type="checkbox"/>	<input type="checkbox"/>	<input type="checkbox"/>	<input type="checkbox"/>	<input type="checkbox"/>	<input type="checkbox"/>	<input checked="" type="checkbox"/>	<input checked="" type="checkbox"/>	<input checked="" type="checkbox"/>	<input checked="" type="checkbox"/>
Analog / XLR	L 1	<input checked="" type="checkbox"/>	<input type="checkbox"/>	<input checked="" type="checkbox"/>	<input type="checkbox"/>	<input checked="" type="checkbox"/>	<input type="checkbox"/>	<input checked="" type="checkbox"/>	<input type="checkbox"/>	<input type="checkbox"/>	<input checked="" type="checkbox"/>	<input type="checkbox"/>	<input type="checkbox"/>
	R 2	<input type="checkbox"/>	<input checked="" type="checkbox"/>	<input type="checkbox"/>	<input checked="" type="checkbox"/>	<input type="checkbox"/>	<input checked="" type="checkbox"/>	<input type="checkbox"/>	<input checked="" type="checkbox"/>	<input type="checkbox"/>	<input checked="" type="checkbox"/>	<input type="checkbox"/>	<input type="checkbox"/>

Preset Replication

Preset Replication allows you to copy presets from a master unit to multiple *iAM-SUM* units. This can save a lot of setup time if multiple units all need basically the same setup.

To start Preset Replication, click on the **Preset Replication** tab on the master unit. This will start the unit discovery process and will list all the *iAM-SUM* units that you currently have on your network. The discovery process will continue for a period of 2 minutes. However, you may stop the discovery process sooner if you believe all the units in the network have been discovered. Simply click the **Stop Scan** button.

Figure 4-18: Preset Replication Scanning Screen

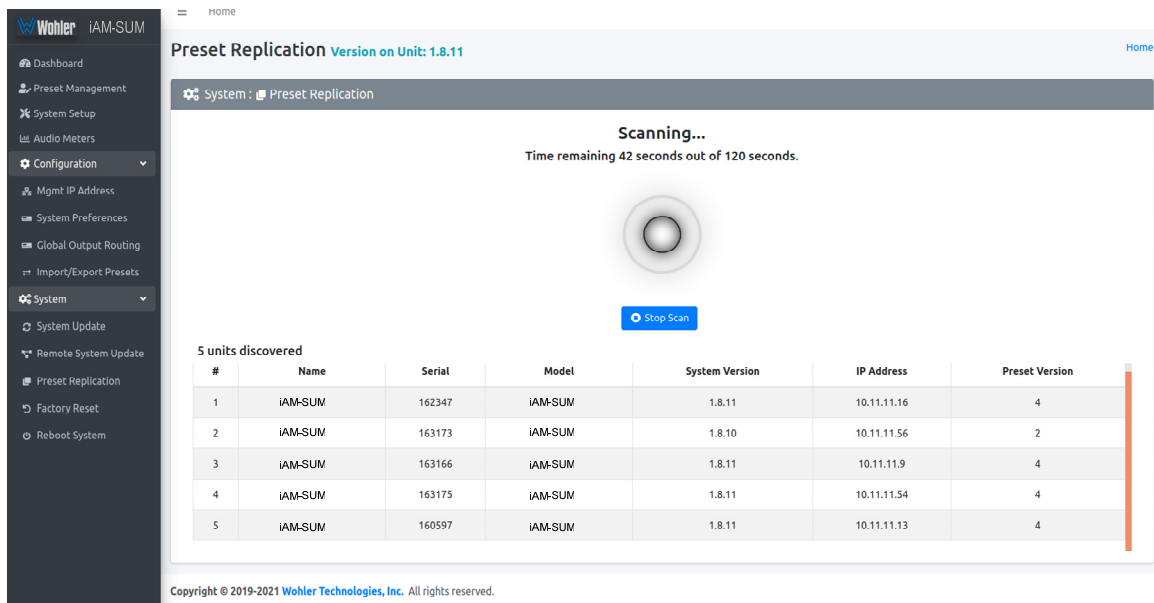

Once all the units are discovered you may either copy the presets that are currently created on the Master unit or can use an external preset file that you want to copy to any or all of the Target units. **Note that any and all of the Presets that may already be contained in each Target unit will be erased by copying the new Presets.**

Figure 4-22: Preset Replication Target Selection Screen

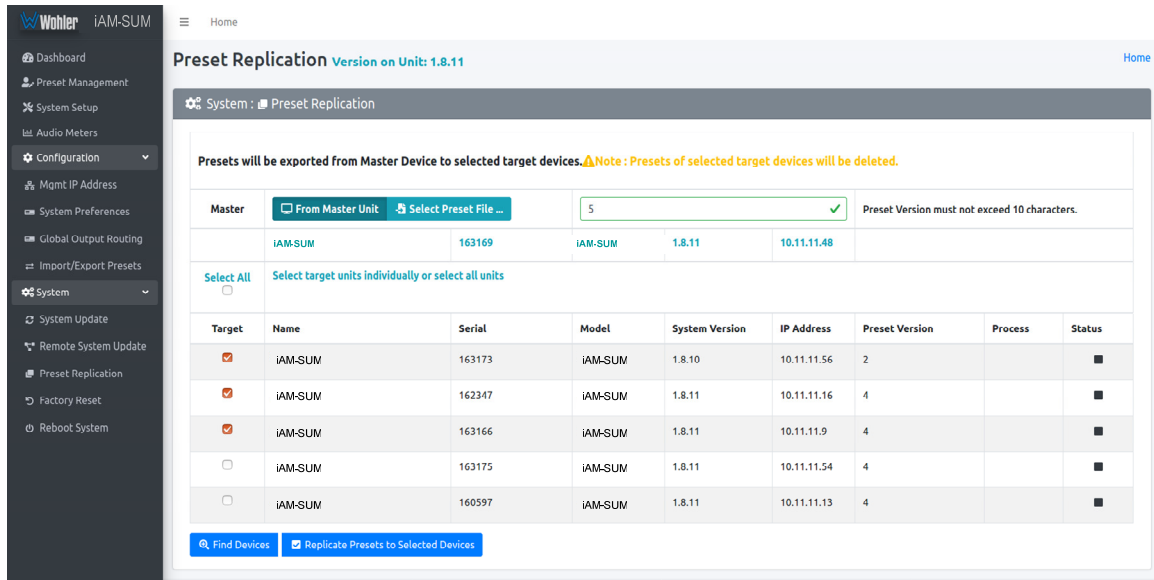

Click either **From Master Unit** or **Select Preset File**. This determines the source of the Presets to be copied. Preset Files would be files that you have previously stored in the computer running the Web GUI.

You may add a descriptive name or version to the Presets being copied. This may aid in remembering what tag or version of the presets are available on the unit. The Preset name or version may be up to 10 characters in length.

Next, select the Target units from the list of units shown by checking or unchecking each of the **Target** boxes at the left. Alternatively, you may click **Select All** to select all of the units. Then select the **Replicate Presets to Selected Devices** button. The progress of the Preset replication for each unit, as the Presets are being copied, will be displayed in the **Process** column. When all of the Presets have been copied to each of the selected units, you may leave this screen.

Import/Export Presets

Use the **Import / Export Presets** page to manage the Preset database in the *iAM-SUM*. You may export the Preset database onto the computer hard drive for security backup purposes or as a means to transfer it to another *iAM-SUM*. Likewise, it can be used to import a Preset database from the computer hard drive into the *iAM-SUM*. In this way, a Preset configuration may be only devised once and then duplicated into all of the *iAM-SUM* units in a system, saving significant effort.

The *iAM-SUM* will create Preset Tags for the each set of Presets. Refer to Figure 4-20. You may also change these Preset Tags, using the Preset Change Field. They allow you to quickly resolve questions about which Presets on various units are the most up to date. They will also allow you to determine whether Presets have been modified. If the Preset Tag displayed contains the suffix "-dirty" then at least one Preset has been changed in some way.

While exporting the file, the Preset Tag is appended to the filename, this allows you to store multiple Preset files with different file name. For example, if the Preset Tag is v1.0.0 then for *iAM-SUM* the default filename would be "**wohler_presets_iAM-SUM-v1.0.0.pdb**" Do not change the file suffix and prefix (marked in red). However, you may change the Preset Tag to any number or text to suit your requirements.

Figure 4-20: Database Export

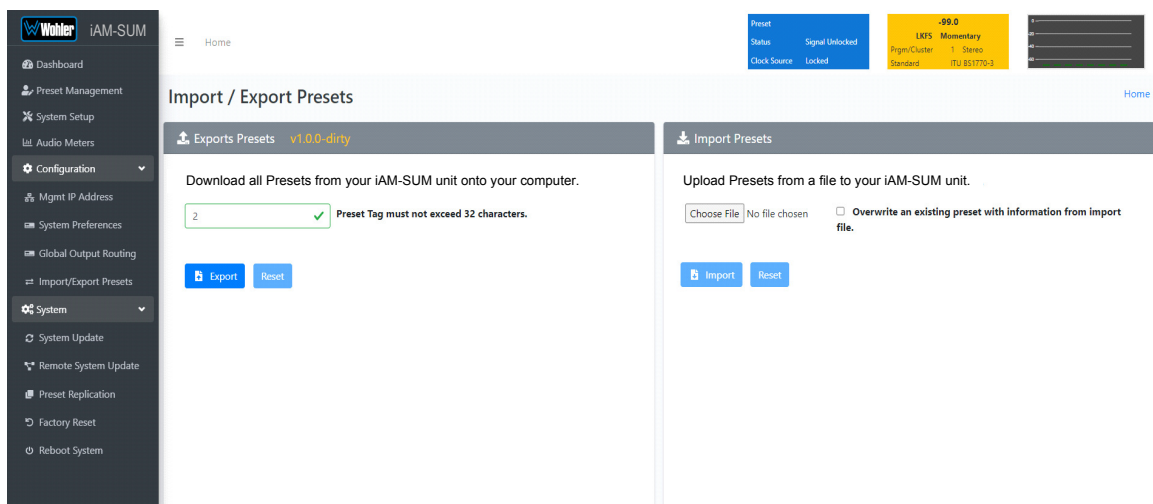

Export Configuration

Use the following steps to save the Preset configuration in the *iAM-SUM* to the computer hard drive:

1. If you need to, revise the Preset Tag name, observing the advice in the advice in the previous section.
2. Click the **Export** button on the **Import / Export Presets** page, as shown in Figure 4-20.
3. A small **Verify** window will appear:

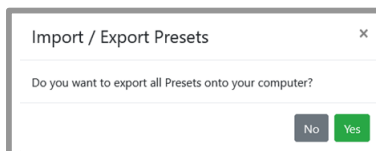

4. Click **Yes** to proceed with writing the Preset data to the hard drive. The copying will proceed. After the Preset data has been written, the screen in Figure 4-21 will appear, explaining what has been exported in an Export Presets Summary. It will also note whether there were any errors in the process. If there were any errors, repeat these steps to try again.

Figure 4-21: Database Export

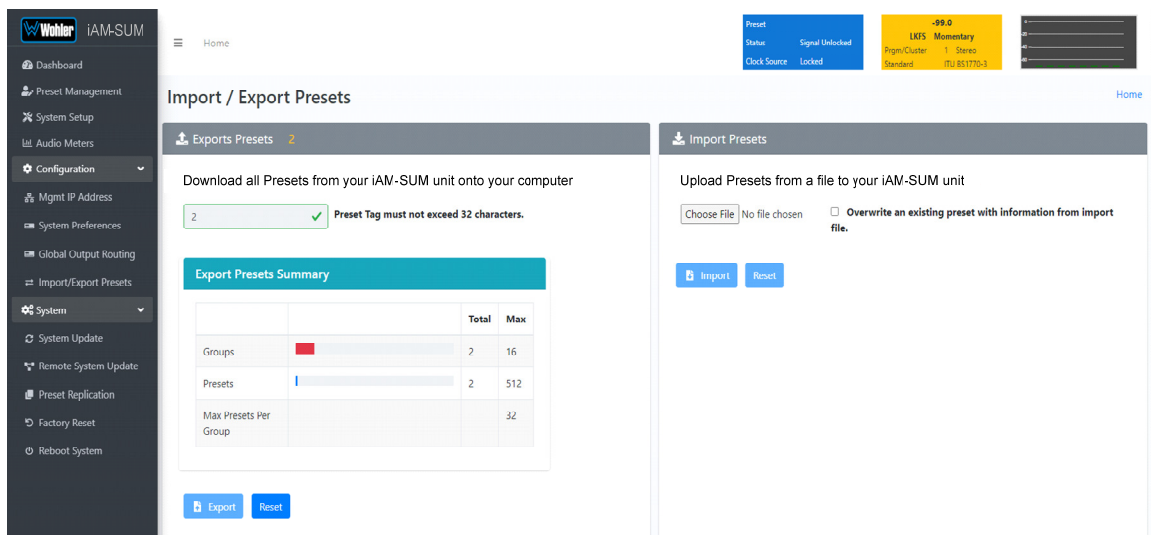

Import Configuration

Use the following steps to copy the Preset configuration into the iAM-SUM:

1. Click the **Choose File** button as shown in Figure 4-21 and select the Preset Tag you would like to import.
2. If you want to allow existing Presets to be overwritten with imported Presets of the same name, check the **Overwrite an existing Preset** box. It is a good idea to do this.
3. Click the **Import** button. The copying will proceed. When complete, the screen in Figure 4-22 will appear, explaining what has been imported in an Import Presets Summary. It will also note whether there were any errors in the process. If there were any errors, repeat these steps to try again.

Figure 4–22: Database Import

The screenshot displays the iAM-SUM web interface for managing presets. The left sidebar contains navigation options such as Dashboard, Preset Management, System Setup, Audio Meters, Configuration, Mgmt IP Address, System Preferences, Global Output Routing, Import/Export Presets, System, System Update, Remote System Update, Preset Replication, Factory Reset, and Reboot System. The main content area is titled 'Import / Export Presets' and is divided into two panels.

The 'Exports Presets' panel (left) is titled 'Exports Presets 2' and contains the instruction: 'Download all Presets from your iAM-SUM unit onto your computer.' Below this is a text input field containing the number '2' with a green checkmark icon to its right. A warning message reads: 'Preset Tag must not exceed 32 characters.' At the bottom of this panel are 'Export' and 'Reset' buttons.

The 'Import Presets' panel (right) is titled 'Import Presets' and contains the instruction: 'Upload Presets from a file to your iAM-SUM unit.' It features a 'Choose File' button, the text 'No file chosen', and an unchecked checkbox labeled 'Overwrite an existing preset with information from import file.' Below this is an 'Import Presets Summary' table.

	Total	Current	Max
Groups	0	2	16
Presets	0	2	512
Max Presets Per Group			32
Skipped Presets	2		

At the bottom of the 'Import Presets' panel are 'Import' and 'Reset' buttons.

System

Click on **System** to find three tabs, each containing important information about the *iAM-SUM*. These tabs are explained in the following three sections.

System Information

This tab displays a variety of information about the *iAM-SUM*. It is shown in Figure 4-23. This information could be useful to view if you are contacting Wohler Technical Service.

Figure 4-23: System Information Tab

The screenshot displays the *iAM-SUM* web interface. On the left is a sidebar menu with 'System Setup' highlighted. The main area shows the 'System Setup' page with three tabs: 'System Information', 'SFP Information', and 'Licenses'. The 'System Information' tab is selected, showing two sections: 'Software Information' and 'Unit Information'.

Software Information	
System Status	Valid
System Version	0.0.2
919476	
Type	Mainboard
State	Valid
Version	0.0.2
Revision	C-1
FPGA Version	0x21060302
MAC Address	00:0a:35:00:01:88

Unit Information	
Serial Number	123456
System IP Address	10.11.11.37
MAC Address	00:0a:35:00:01:88
Name	<input type="text" value="iAM-SUM"/>

Buttons: Apply, System Log Information

SFP Information

This tab displays a variety of information about the module inserted into the SFP slot on the rear panel of the *iAM-SUM*. It is shown in Figure 4-24. This information could be useful to view if you need to ascertain what module, if any, is installed, or if you are contacting Wohler Technical Service.

Figure 4-24: SFP Information Tab

The screenshot shows the *iAM-SUM* System Setup interface. The sidebar menu on the left has 'System' highlighted. The main content area is titled 'System Setup' and has three tabs: 'System Information', 'SFP Information', and 'Licenses'. The 'SFP Information' tab is active and shows a dropdown for 'SFP Slot 1'. Below this, there is a 'Hardware Information' table with the following data:

Hardware Information	
Description	Software-defined, non-MSA, SDI host
Short Description	Software-Defined
Approved	True
Vendor Name	EMBRIONIX
Vendor Part Number	EB22LC2B-SN
Vendor Revision	10Z
Wohler Part Number	790047

Note: SFP Information, as shown in lower half of Figure 4-24, can be used to retrieve the 2110 or 2022 SFP Module network configurations. This is useful if the customer forgets the IP address assigned to these SFP modules.

Licenses

This tab displays the license number for each of the modules or features in the *iAM-SUM*. It is shown in Figure 4-25. You will use this tab to enter any new license numbers that you purchase. Contact Wohler Sales to obtain new license numbers. If you need help, Wohler Technical Service will be happy to assist you in installing these numbers.

Figure 4-25: Licenses Tab

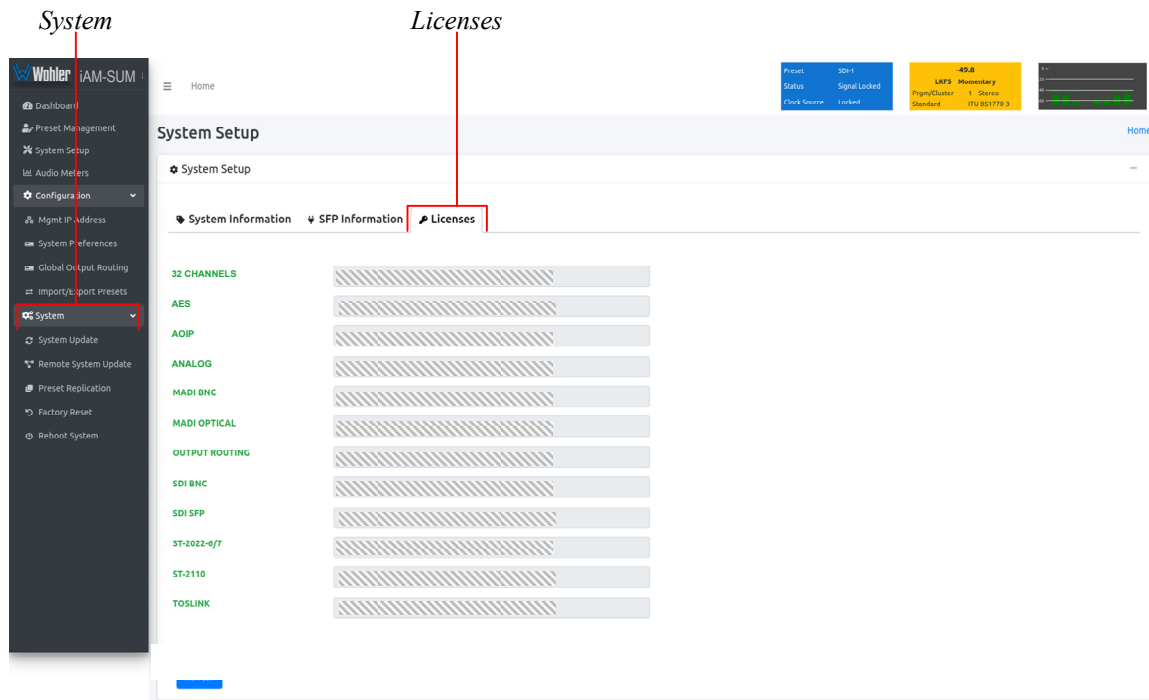

The example above shows an *iAM-SUM* with license keys for inputs and license keys for SFP modules installed.

To enter the license key provided to you by Wohler Customer Service, use the following steps:

1. Click the field to the right of the input or module desired.
2. Enter the license key in the box.
3. Repeat Steps 1 and 2 for any other license keys that you want to enter.
4. Click the **Refresh** button to save the information. Each new license will be immediately available for use.

Factory Reset

The **Factory Reset** function should be used with caution. It deletes all of the settings you have programmed into the system. It returns the system to the way it was when received new from the factory. After using this function, you will need to reprogram everything from the start.

Figure 4–26: Factory Reset

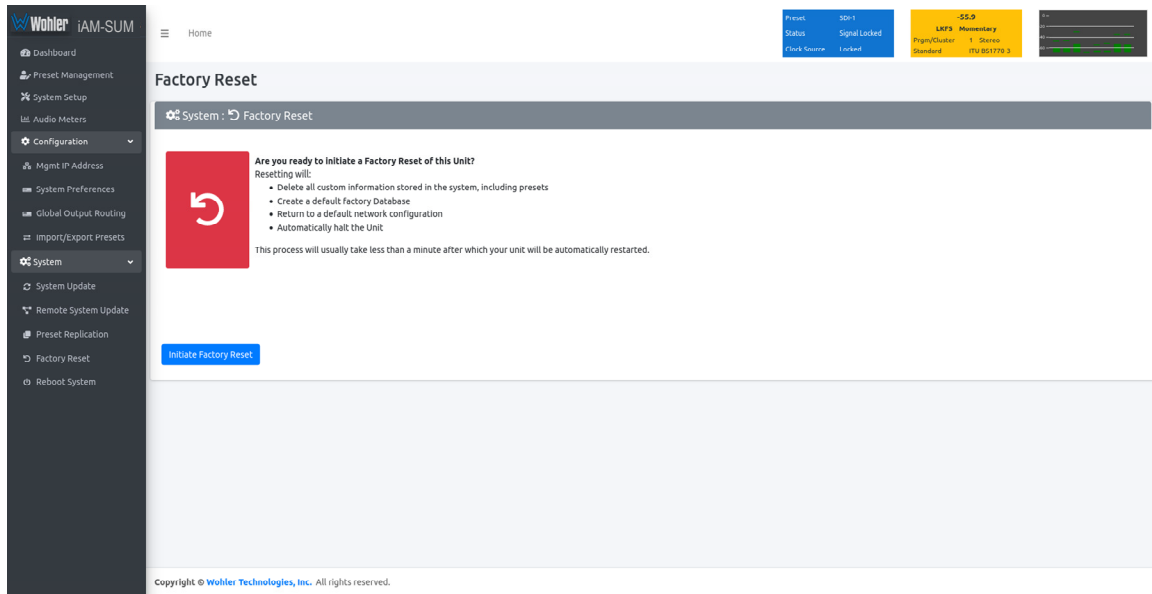

If you have any doubt as to whether you should perform a Factory Reset, **do not** click the **Initiate Factory Reset** button. Contact Wohler Technical Service for advice.

Note: **Factory Reset** will also reset your IP address to the default one. After a Factory Reset, the IP Settings will need to be updated. The default IP address for the unit is determined based upon the Mac address. It is 169.254.1.xx where xx is the last octet of the management Mac address. For example, if the Mac address is b4:ed:54:d0:04:28 then the IP address would be 169.254.1.40 (40 is the decimal equivalent for the last octet of Mac address 28.)

Reboot System

The **Reboot System** page allows you to reboot an *iAM-SUM* remotely. The **Reboot System** page is shown in Figure 4-27. This function is normally only used upon request from Wohler Technical Service to troubleshoot or correct an issue.

The **Reboot System** function should be used with a bit of caution. It puts the *iAM-SUM* out of service for several minutes while it is rebooting, and this may unexpectedly interfere with the use of the product by the remote operator.

Figure 4-27: Reboot System

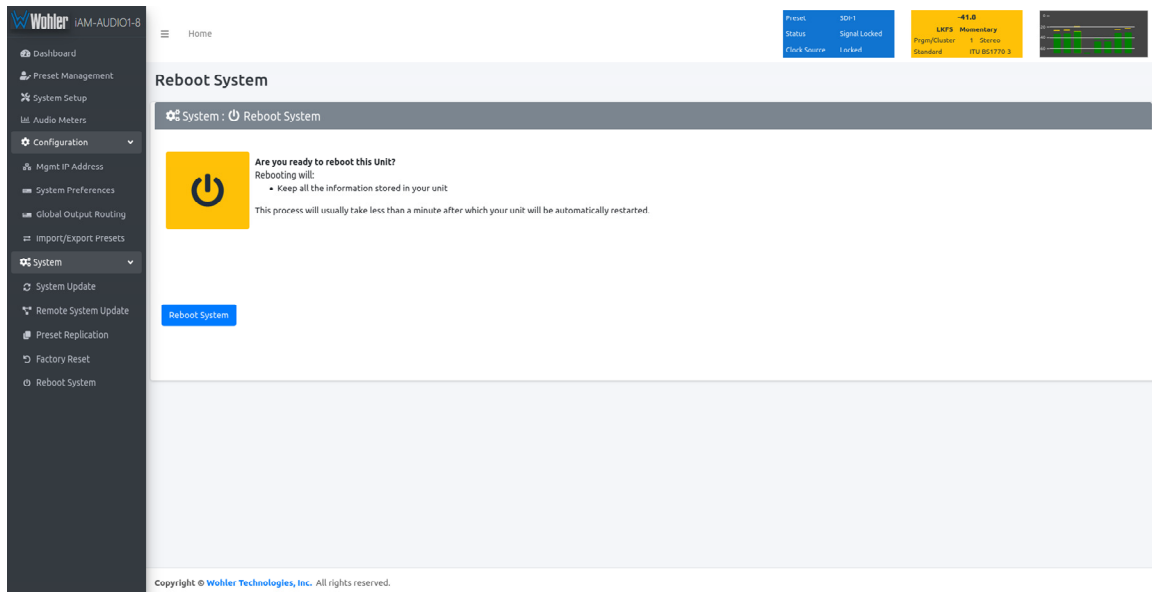

If you have any doubt as to whether you should reboot the remote *iAM-SUM*, **do not** click the **Reboot System** button. Contact Wohler Technical Service for advice.

APPENDIX A: Software Upgrades

Introduction

This chapter describes how to download a software update file to your computer, transfer it to a USB flash drive and install the updated into an *iAM-SUM*.

Download the Software

The *iAM-SUM* software update can be found at <http://www.wohler.com>, under Product Downloads on the Products > *iAM-SUM* page, in Support > Downloads > Drivers & Software, or contact Wohler Customer Support for more information.

Unzip the downloaded update files to reveal two files. One will have a suffix of **.wx** and the other will have a suffix of **.md5sum**. Both files are needed for the upgrade.

Update Methods

There are several software update methods. Select one of them, depending upon your needs:

1. Local update from the front panel of the *iAM-SUM*: This straightforward method does not require the use of the Web GUI. A flash drive containing the update is plugged into the front panel USB socket and the update is then accomplished using the self-contained menu system. If this method seems most suitable, then refer to the [Local Update from the Front Panel](#) section of this chapter.
2. Remote update using the Web GUI with a flash drive connected to the *iAM-SUM*: It may be more convenient to update the product using a flash drive plugged into its front panel USB socket, but controlled remotely via the Web GUI. To update the product this way, refer to the [Updating via the Web GUI](#) section of this chapter.
3. Remote update without a flash drive: This method allows you to update a networked *iAM-SUM* remotely without plugging a flash drive into its front panel USB socket. To update the product this way, refer to the [Updating an *iAM-SUM* Remotely](#) section of this chapter.
4. Update multiple units remotely at once: This method allows you to update multiple networked *iAM-SUM* units at once, without plugging flash drives into their front panel USB sockets. To update products this way, refer to the [Updating Multiple *iAM-SUM* Units Remotely](#) section of this chapter.

Local Update from the Front Panel

Use the following steps to update the *iAM-SUM* software:

1. Copy the unzipped Wohler Update Package file(s) from your computer to the root directory (not inside of a folder) of a USB flash drive. It must be FAT32 file type, and does not need to be empty. Refer to the [Download the Software](#) section of this chapter for the specifics of download and file transfer to the USB flash drive.
2. Insert the USB flash drive with *iAM-SUM* update package(s) into the front panel USB jack.
3. From the **Menu** screen, touch **System Options**. The screen shown in Figure A-1 will appear.

Figure A-1 - System Options Screen

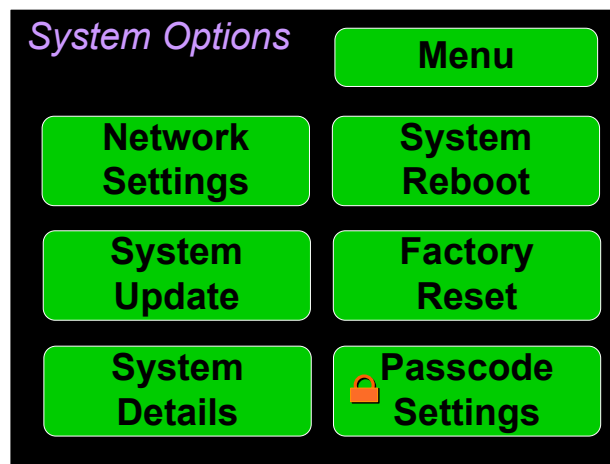

4. In the **System Options** menu, touch **System Update**. The **Software Upgrade** screen will appear, as shown in Figure A-2.

Figure A-2 - Software Upgrade Screen

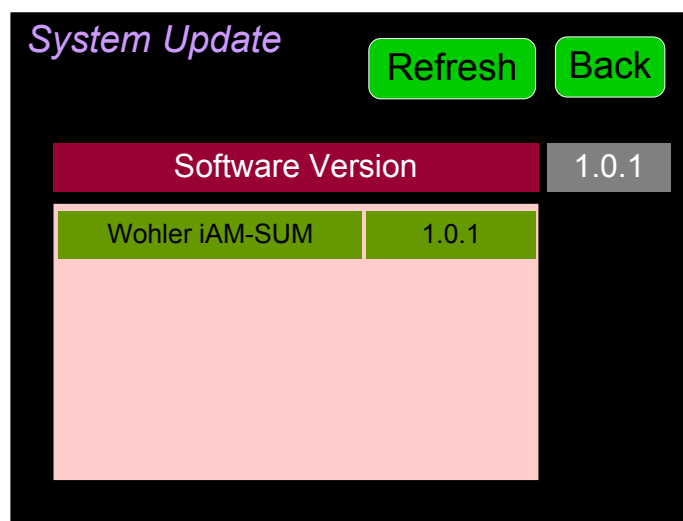

- The new software version that is in the flash drive will be shown in the **Software Version** screen. To cancel the upgrade at this point for any reason, touch **Back**. To proceed, touch the software version entry in the **Software Version** screen. A screen will appear, as shown in Figure A-3.

Figure A-3 - Upgrade Verify

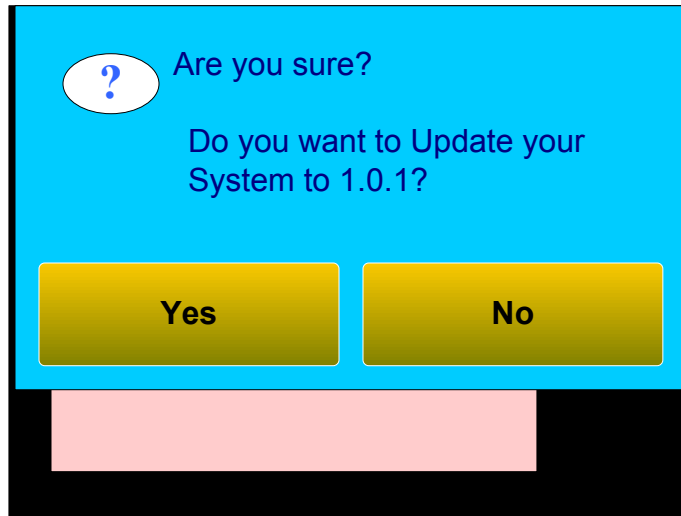

- To proceed, touch **Yes**. To back out, touch **No**. After you touch **Yes**, the screens will change, as shown in Figure A-4. The left screen will display "Software Upgrade in Progress" until the upgrade is complete.

Figure A-4 - Upgrading System

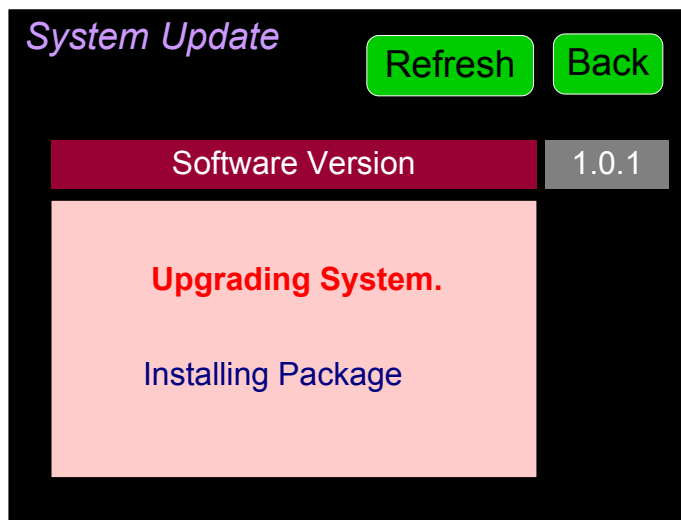

After the software update starts, the text on the left screen will change periodically to indicate the progression of the upgrade. The upgrade will take 5 minutes or more, after which the *iAM-SUM* will restart. After the system has completed its restart cycle and is once again operational, you may then remove the flash drive.

Important:

Do not interrupt or remove power to the iAM-SUM, or remove the USB drive during the installation process. Doing so could crash the iAM-SUM software.

Updating via the Web GUI using a Flash Drive

Use the following steps to update the iAM-SUM software:

1. Copy the unzipped Wohler Update Package file(s) from your computer to the root directory (not inside of a folder) of a USB flash drive. It must be FAT32 file type, and does not need to be empty. Refer to the [Download the Software](#) section of this chapter for the specifics of download and file transfer to the USB flash drive.
2. Connect to the iAM-SUM with the Wohler Web GUI. Navigate to the **System | System Update** menu, as shown in Figure A-5.

Figure A-5 – System Update Menu

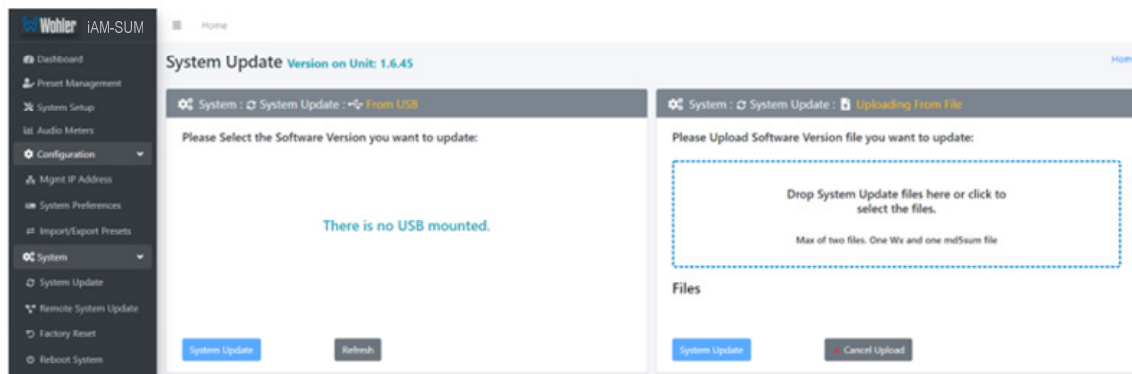

3. Click on the **Refresh** button.
4. Available software update(s) are shown as in Figure A-6. Click the one you want, followed by clicking the **System Update** button.

Figure A-6 – Available Software Updates

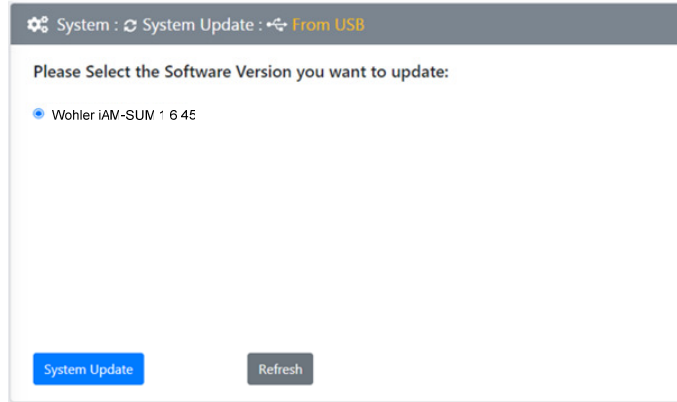

5. After clicking the System Update button, a verification screen displays as shown in Figure A-7. If you agree that the correct update version has been selected, click the **Yes** button.

Figure A-7 – System Update Verification

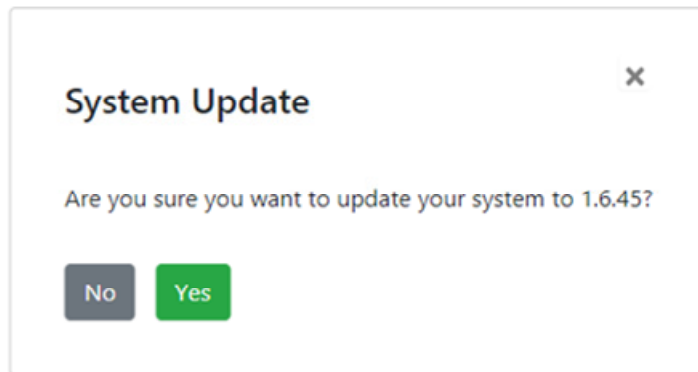

6. Next, the update begins, showing the screen in Figure A-8. The circle in the center of the screen, along with status messages below it, will indicate the progress of the update.

Figure A-8 – Software Upgrade in Progress

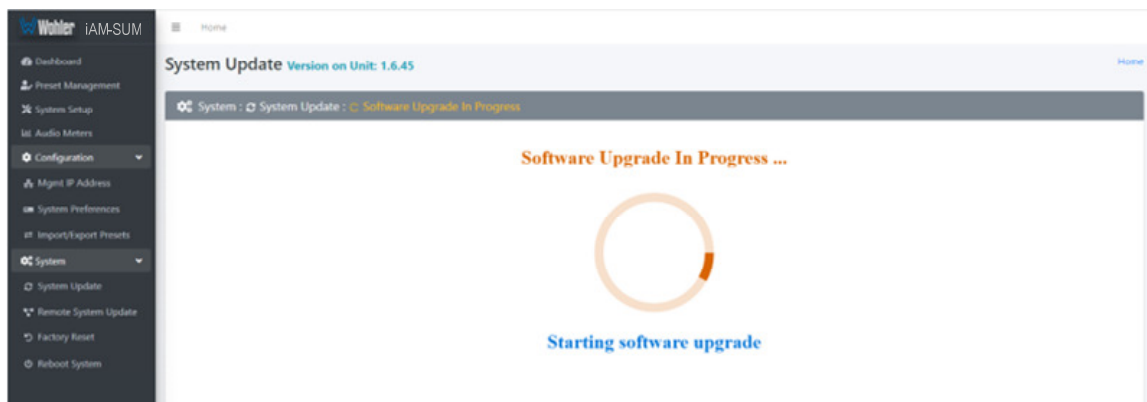

7. At this point, wait for the update to complete. It may take several minutes, but **it is critical not to disturb the iAM-SUM or the Web GUI** until the update process is complete. When it is complete, the iAM-SUM will restart.

Updating an iAM-SUM Remotely

Use the following steps to update the iAM-SUM software:

1. The Software Update files you downloaded earlier must be in the same computer that is running the Web GUI. Connect to the iAM-SUM with the Wohler Web GUI. Navigate to the **System | System Update** menu. Click within the large blue dotted line rectangle at the right of the screen. A file selection window will open, as shown in Figure A-9.

Figure A-9 – System Update Menu

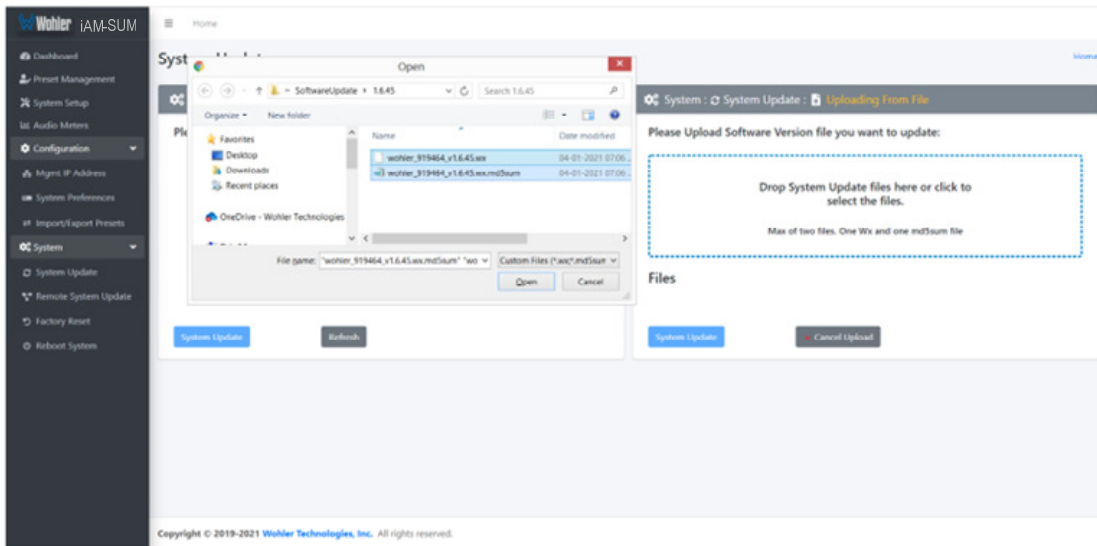

2. Click the two update files. One will have a suffix of **.wx** and the other will have a suffix of **.md5sum**. If you make a mistake and click the wrong file(s), click the **Cancel Upload** button and try again. When the files have uploaded, the **System Update** button will be enabled. Click it. If there is a problem with the files as this point one of the screens shown in Figures A-10 or A-11 will appear. In that case follow the directions on the screen to retry. If there are no problems, the update will proceed and the screen shown in Figure A-8 will appear.

Figure A-10 – Invalid System File Version

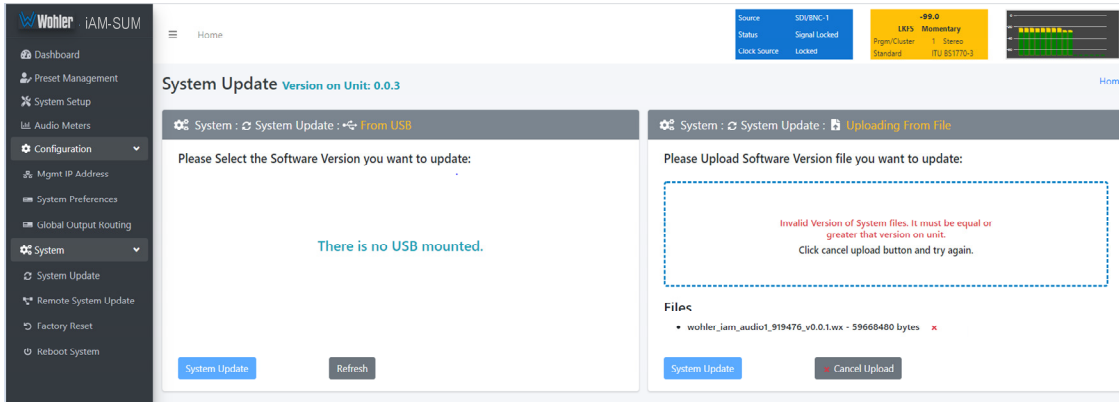
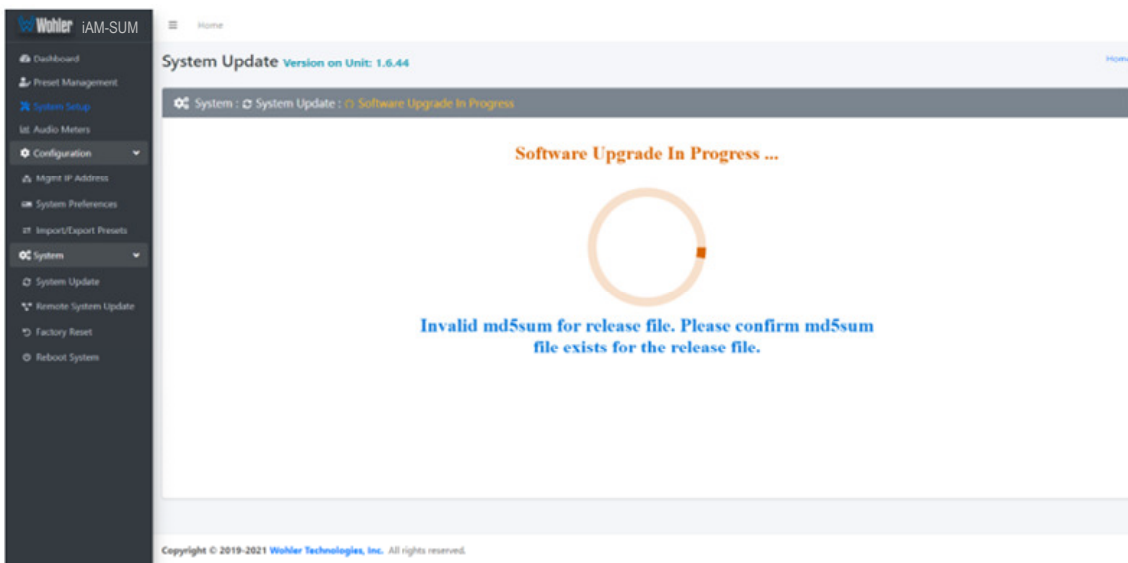

Figure A-11 – Invalid Checksum



3. At this point, wait for the update to complete. It may take several minutes, but **it is critical not to disturb the iAM-SUM or the Web GUI** until the update process is complete. When it is complete, the iAM-SUM will restart.

Updating Multiple Units Remotely

Use the following steps to update one or more *iAM-SUM* units remotely by transferring the software from a previously updated *iAM-SUM*:

1. If any of the *iAM-SUM* units that you intend to update remotely may be in use, contact the people using them and let them know what you will be doing. The *iAM-SUM* units being updated will be temporarily out of service.
2. Use the Wohler Web GUI to connect to an *iAM-SUM* already containing the latest update. This will be referred to as the **Master Unit**. Navigate to the **System | System Update | Remote System Update** menu. The screen shown in Figure A-12 will appear and the Web GUI will scan the network for any active *iAM-SUM* units.

Figure A-12 – Scanning for *iAM-SUM* Units

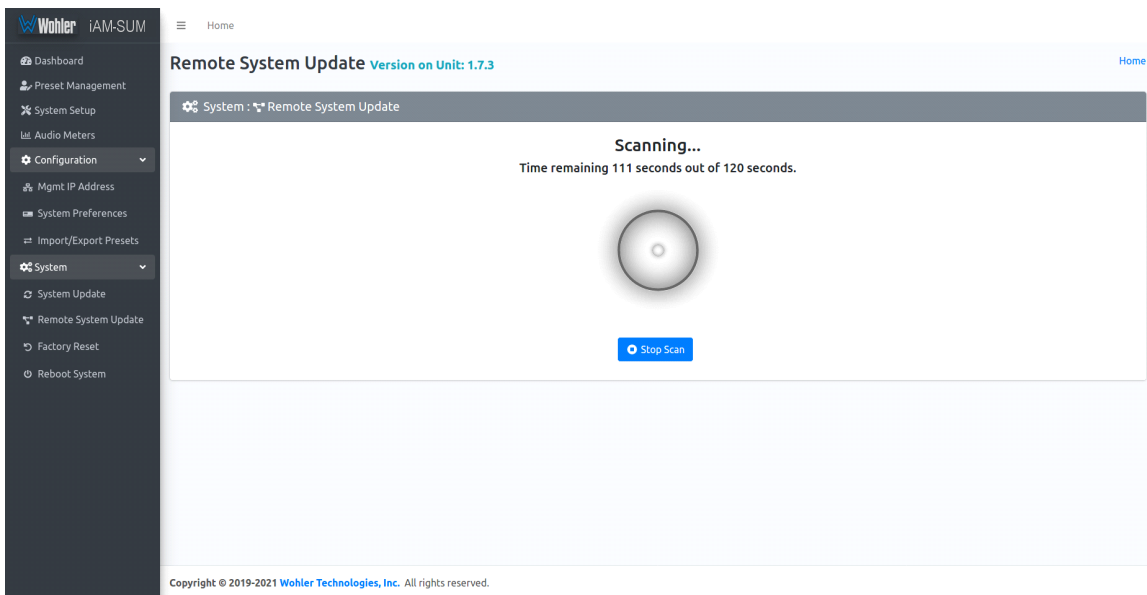

Note: The scanning process will take 2 minutes. Progress is shown on the screen. If for some reason you would like to stop the scan prematurely, click the **Stop Scan** button.

Important: **Do not** run the scanning or updating process from **more than one Master Unit** at a time, to avoid problems. Although you may be updating multiple units at the same time, never attempt this process from more than one **Master Unit**.

3. When the scanning is complete, a list of found *iAM-SUM* units will be shown as in Figure A-13. Click either **Select All** or click only the **Target** units that you want to update.

Figure A-13 – List of Found iAM-SUM Units

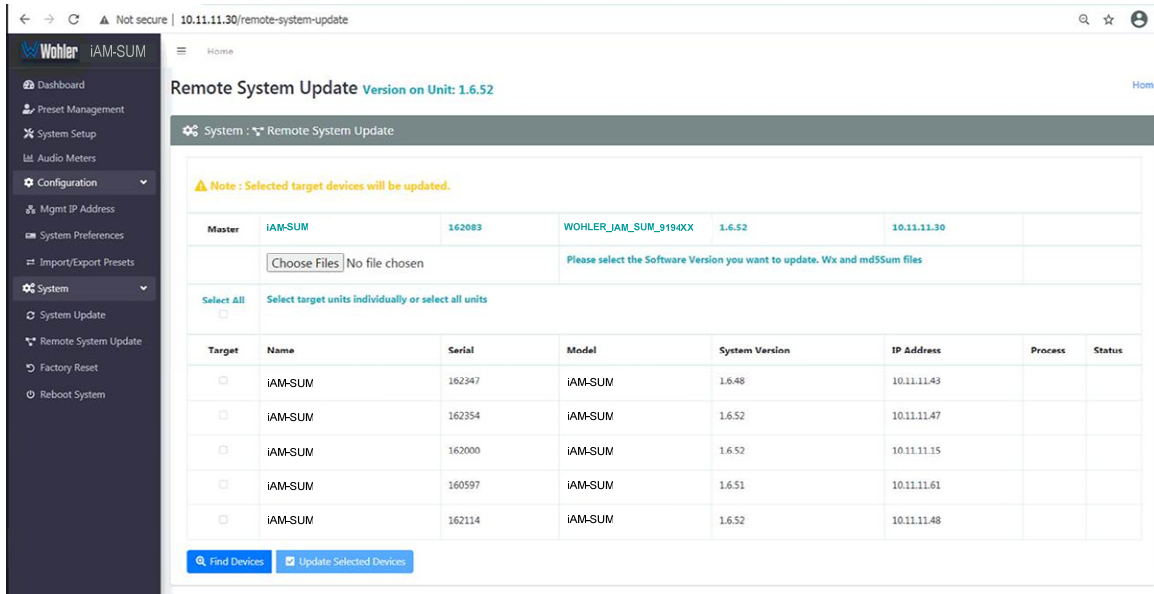

- Then click **Update Selected Devices**. The window shown in Figure A-14 will appear.

Figure A-14 – Apply System Package

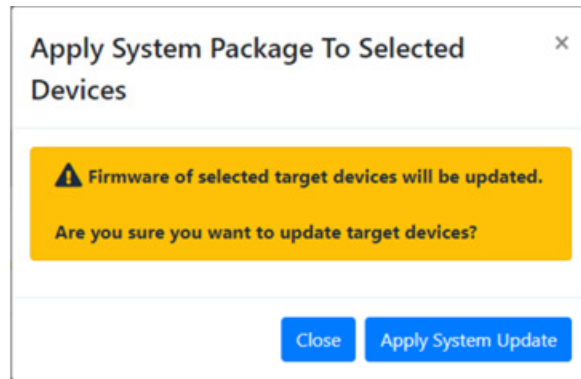

- Click **Apply System Update**. The screen shown in Figure A-15 will appear. This screen contains a table showing the update progress of each of the iAM-SUM units being updated.

Figure A-15 – System Update Progress

The screenshot shows the 'Remote System Update' page in the iAM-SUM web interface. The page title is 'Remote System Update Version on Unit: 1.1.14'. A note states: 'Selected target devices will be updated.' Below this, there is a table with columns: Master, Name, Serial, Model, System Version, IP Address, Process, and Status. The table lists one target device with the following details:

Target	Name	Serial	Model	System Version	IP Address	Process	Status
<input type="checkbox"/>	iAM-SUM	162159	WOHLER_IAM_SUM_919476	1.1.13	192.168.0.188		■

At the bottom of the table, there are two buttons: 'Find Devices' and 'Update Selected Devices'.

- At this point, wait for each update to complete. It may take several minutes, but **it is critical not to disturb any of the iAM-SUM units or the Web GUI** until the update process is complete. When it is complete, each iAM-SUM will restart.

APPENDIX B: Dante Network Setup

Introduction

Installing the *iAM-SUM* into an existing and functioning Dante network is virtually plug and play. The *iAM* rear panel AoIP jack supports 1Gb/s and 100Mb/s Ethernet devices in Dante Audio over IP network configurations.

The AoIP option on the *iAM-SUM* supports Hitless and has 2 RJ-45 interfaces, a primary interface and a secondary interface.

Additionally, an SFP slot is provided to receive the AoIP signal using network fiber SFPs. These are 1G SFP slots. The SFP slot always acts as a primary interface.

On *iAM-SUM*, the AoIP source can be selected through the Source Select option.

The *iAM-SUM* is set up at the Wohler factory to be used as a slave rather than a master within the Dante network. Other devices or software, such as a **Dante Controller**, are expected to be responsible for most device configurations and all audio routing.

Please refer to the ***Dante Controller User Guide*** or other control device documentation for specific network and device setup information. The next section provides a guide to configuring the card and AOiP port.

What is in the *iAM-SUM* for Dante?

The Dante AOIP option consists of an Audinate Brooklyn II card directly connected to the AOIP port. This port is dedicated to the card and should not be confused with the Wohler unit Management port. These two ports must be on two different subnets, one for the AOIP network and the other for access to the Wohler Web GUI for management of the Wohler unit itself. Either one can be configured to have static or DHCP addresses. The Wohler Web GUI indicates the presence of the Dante card and the AOIP license but does not provide access to the various configuration parameters internal to the card. The speed of the AOIP port is 1G default or 100Mbps.

The Audinate® Brooklyn II card has a simple process to set its initial IP address. The initial factory setting for the card's AOIP port is DHCP. When connected to a DHCP based Dante network and the unit powered on, the Dante card sets the DHCP server provided address as its default address.

Therefore, if the Dante network has a DHCP server, the unit can be inserted into the network and can be configured further using the Audinate application, Dante Controller, running on a host on the same DHCP based subnet.

If the Dante network is static based or if DHCP fails, the card sets a static Link Local arbitrary address in the format 169.254.x.y, where x and y are each in the range 0 to 255. The mask is set to 255.255.0.0 to provide a ~65000 entry address space.

The Dante Controller host must also have a Link Local address to communicate with the card over the unit's AOIP port. Connect the AOIP port directly to a host (e.g. laptop) running the Dante Controller, where the host address is preconfigured to an

arbitrary Link Local address (169.254.x.y, mask 255.255.0.0). The connection can be direct cable or through a switch. The Dante Controller **Device Info** tab shows the card's default static address, speed, etc. By double clicking its entry line, additional settable parameters on the card can be reconfigured to be compatible with the Dante network addressing and other parameters as necessary. When the unit is rebooted on the Dante network, the card will be seen by the Dante Controller used to manage the overall network.

If the Dante Controller **Device Info** tab detects the card but does not allow modification and full presentation of card internals, the **Card ID** will be shown in red, e.g. Wohler-xxxxxx where xxxxxx is the last 6 hex digits of the card MAC address as shown in B-1. This usually indicates that the IP address of the card is not in the same subnet as the Dante Controller host. By double clicking the ID, a **Device View** screen will appear as also shown in Figure B-1 with further details about the two incompatible addresses. Change the address of the host or move the unit to another host with an address compatible with the Dante card.

Figure B-1 – Dante Controller Device Info Tab

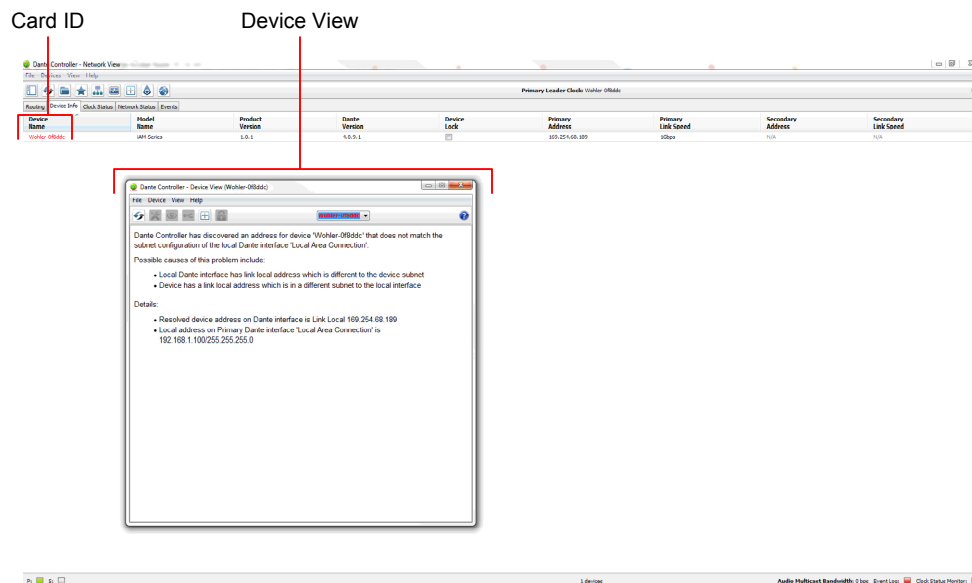

Up to 8 of the 64 AoIP receive channels can be monitored at once in the *iAM-SUM*. The *iAM-SUM* transmits up to 8 channels. 1 to 8 are the monitored channel in prefade mode. The remaining four are reserved for future use. Currently they are mapped to channels being monitored on meter 1 to 4 in post-fade mode. The eight *iAM-SUM* monitored channels are transmitted to the Dante network.

The *iAM-SUM* Dante™ AoIP is configured by the *iAM-SUM* to receive up to 64 channels and transmit 8 channels of Dante AoIP at 48 kHz or 44.1 kHz audio sample rates. 48 kHz is the *iAM* default rate.

Sample rate selection is left up to the Dante™ Controller device or software. *All devices connected to each other through a Dante network must be set to the same sample rate.* Slight ticking may be heard in the *iAM-SUM* monitor when monitoring different input types at different sample rates or if sources are asynchronous.

Dante™ Device Setup

The *iAM1-SUM* default **Dante Device Name** is “Wohler- ...” followed by the last 6 digits of the Dante port MAC address, as shown in Figure B-2. This name can be changed by the Dante Controller to appear that way on the network, but that will not change the *iAM-SUM* unit name appearing on GUI pages and *iAM-SUM* **Remote Metering** or **Discovery** pages.

Figure B-2: *iAM-SUM* Name

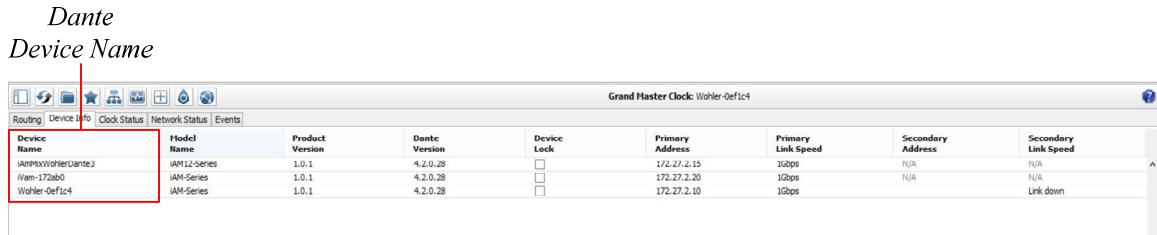

During initial setup, you may want to manually change the *iAM* unit **Name** in the [System Setup](#) page to match the reassigned **Dante Device Name** for consistency. Refer to Figure B-3.

Figure B-3: Rename *iAM*

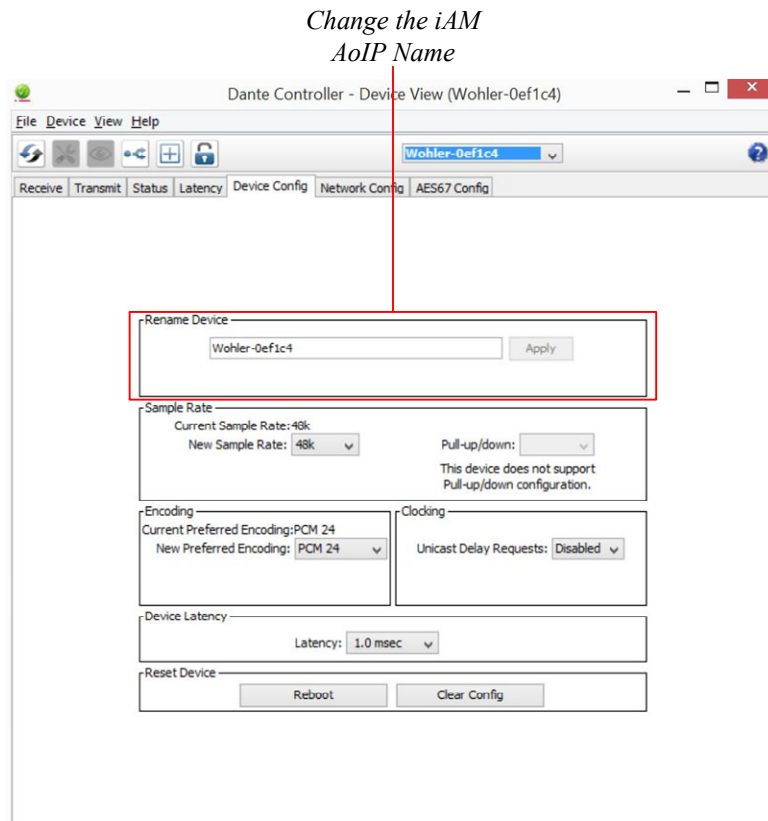

Other changes such as **Latency** settings can be made by the Dante Controller through the **Device View** menus. Some changes may require remote rebooting of

the Brooklyn II card to take effect, temporarily interrupting audio and publishing the new information to the network.

Important:

Only 44.1 kHz and 48 kHz audio sample rates are currently supported by the *iAM-SUM*. The Brooklyn II card would accept a Dante Controller command to operate at other rates, without giving an indication it will not be implemented.

Dante Clock Selection

While the Brooklyn’s internal clock is highly accurate, the *iAM-SUM* does not have provisions for external sync clocks, such as those that are GPS or media reference (video genlock or audio word clock) based. So it is generally not the best candidate to be the PTP Master Clock (commonly called the “grandfather clock”) for the network. It can be set as the preferred master if no better clock source exists. Refer to Figure B-4.

The *iAM* Brooklyn Dante card will serve as a temporary fallback clock source if preferred masters are interrupted. It functions as an accurate slave clock synchronized to the master clock on the network when not operating as the master.

Figure B-4: Clock Selection

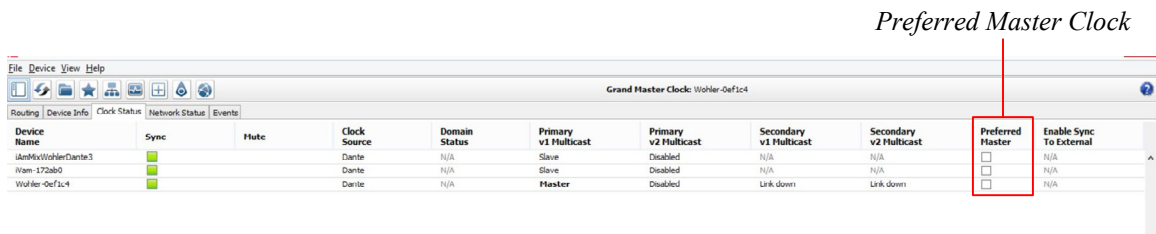

Channel Names

The factory default channel names are set to "01 to 64" for 64 received channels and "Monitor Ch 1" to "Monitor Ch 8" for first 8 transmitted channels. The next 4 transmitted channels are set to "Mix Ch 1" to "Mix Ch 4".

Note: To change channel names please refer Dante controller user manual.

AES67

The *iAM-SUM* Brooklyn II can be configured for AES67 operation. Refer to Figure B-5. AES67 operation with Dante is limited to eight or less receive and transmit channels at 48 kHz sample rates.

24 bit linear (L24) encoding and 1 msec packet time are fixed default transmit parameters.

16 bit (L16) or 24 bit (L24) encoding and 125/250/333/100 µsec packet times can be received.

The **Device View - AES67 Config** menu enables/disables AES67.

Figure B-5: AES67 Enable/Disable

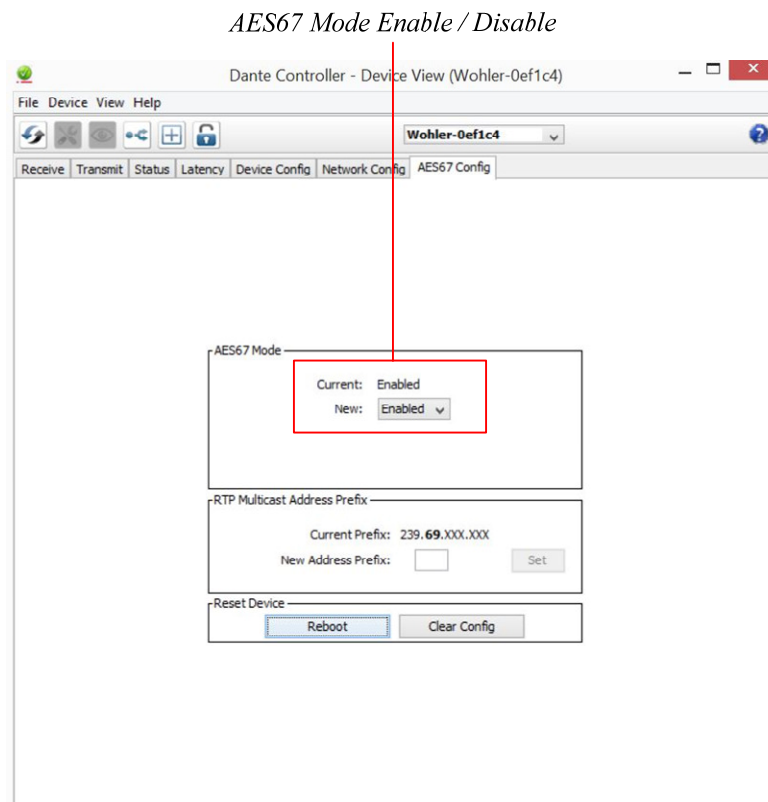

Further, Dante AES67 discovery and operational protocol requires manual assignments for static multicast transmit and receive IP addresses per Dante protocols for discovery and IGMP network operation. Destination addresses in range 239.nnn.0.0 – 239.nnn.255.255, port 5004 or nnn can be configured using the Dante Controller. The default is 69. The destination and receive address range must match. Provisions for this are in **Dante Controller Device View - Network Config**. Refer to Figure B-6.

Figure B-6: Device View - Network Config

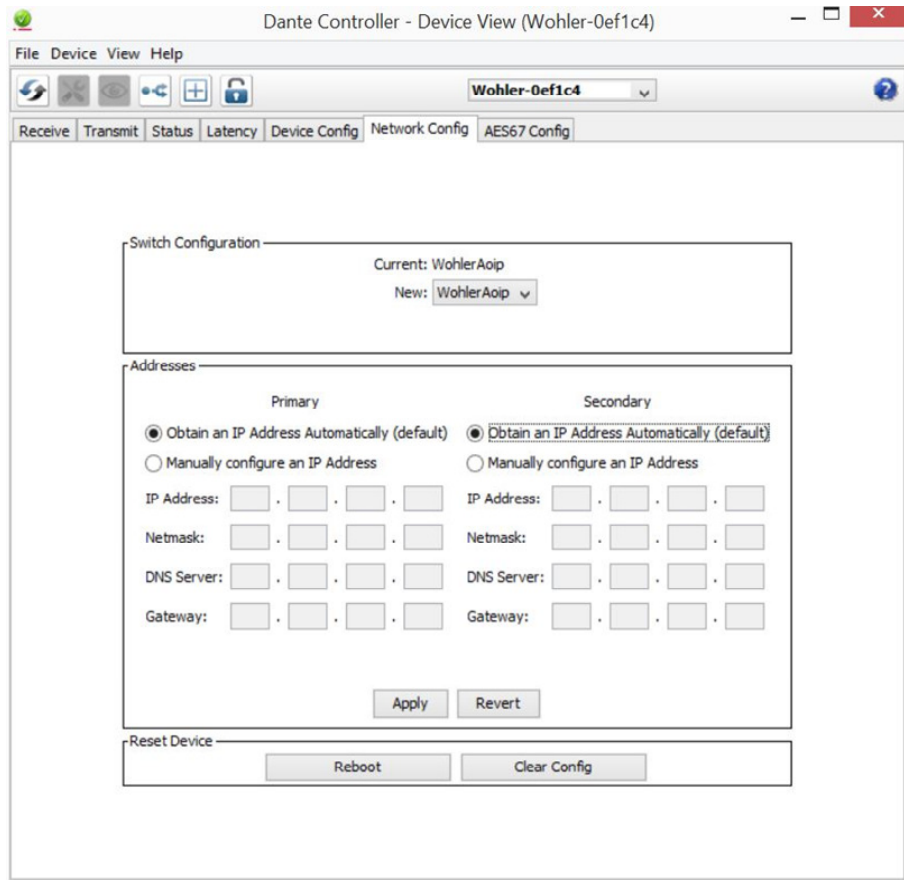

The channels to be multicast are selected in the File menu-**Create Multicast Flows** window shown in Figure B-7.

Figure B-7: Multicast

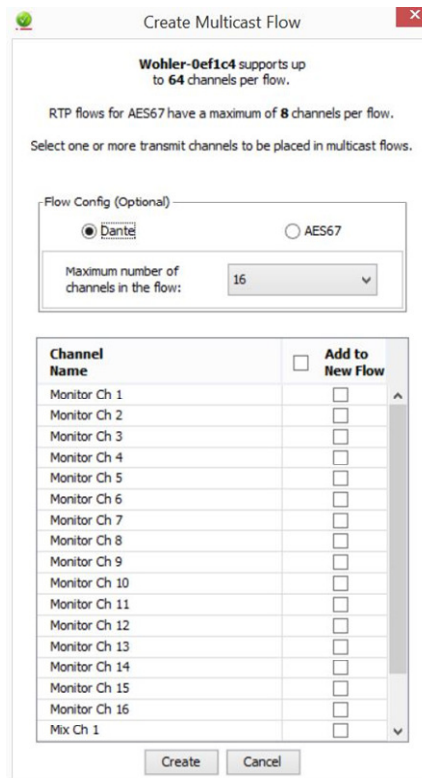

Device Lock

Audinate recently added a feature whereby a remote controller can send a command to lock Dante network device configurations. The *iAM-SUM* does not implement the Device Lock command at this time.

Dante Firmware Upgrades

Wohler *iAM-SUM* monitors ship with current Brooklyn II firmware as of the option installation date. The version information is found in the **Dante Controller Device View-Status** page. *iAM* software/firmware is tested with the latest Dante code release. Therefore it is strongly recommended that *iAM-SUM* and Dante software/firmware be updated at the same time to ensure compatibility and support of the latest features.

Use the Audinate **Dante Firmware Update Manager** Windows or OS X application to update the Dante firmware over the Dante network. Follow the application's installation and usage guide plus any applicable technical notes available.

Additional Information

The following links are provided for those who need more information about the Dante controller or the Dante Firmware update manager.

<https://my.audinate.com/products/firmware-update-manager>

<https://www.audinate.com/products/software/dante-controller>

<https://dev.audinate.com/GA/dante-controller/userguide/pdf/latest>

Dante™ Legal Disclosures

TRADEMARK ATTRIBUTION: Products covered in the manual include licence from Audinate Pty Ltd under US Patents 7747725, 8005939, 7978696, 8171152, European Patent 2255541, Chinese Patent ZL200780026677.0 and other patents pending or issued, see www.audinate.com/patents or such other legend as Audinate may stipulate from time to time to the Manufactured Product and any packaging and marketing materials therefor.

APPENDIX D: Ravenna (ZMAN) Setup

Introduction

Installing the *iAM-SUM* into an existing and functioning Ravenna network using the Merging ZMAN Card is virtually plug and play. The *iAM* rear panel AoIP jack supports 1Gb/s and 100Mb/s Ethernet devices in Ravenna Audio over IP network configurations.

iAM-SUM channel source selections are made by choosing **Input Type 'AoIP'** in the [Configuration-Configure Presets](#) page regardless of which AoIP option is installed.

Note: In addition to the *iAM-SUM* configuration, the Merging ZMAN Card needs to be configured using its own configuration tool. The menus in this configuration tool are shown in this Appendix.

What is in the *iAM-SUM* for Ravenna?

The AES67 enabled Merging ZMAN Card supports the following features:

RAVENNA-Compatible Talker/Listener

- 1) RFC 3551 – RTP Profile for Audio and Video Conferences
 - a) L16 16-bit linear format defined in RFC 3551 clause 4.5.11
 - b) L24 24-bit linear format defined in RFC 3190 clause 4
 - c) AM824 24-bit Audio as defined in IEC61883-6
 - d) Multicast and unicast session support
 - e) 48 kHz and 96 kHz audio sampling rates
 - f) 1 to 8 audio channels per stream
 - g) Up to 64 streams
- 2) Media clock support
 - a) 48 kHz and 96 kHz
- 3) Hitless Stream Redundancy
- 4) IGMP v3 support
- 5) Session Announcement Protocol (SAP) support

AVB Ethernet Features

AVB uses the concept of streams and channels. A stream is a connection from one talker to one or more listeners. One stream can be made up of 1-60 audio channels. The Ravenna option supports the following AVB features:

- 1) AVB 1722 AVTP with multiple subtypes:
 - a) IEC 61883-6 MBLA
 - b) AM824, 24-bit Audio Encapsulation
 - c) Support up to 64 streams
 - d) Up to 8 channels per stream

- e) 512+512 Channels of audio
- f) 48kHz and 96kHz sampling rates
- 2) IEEE 802.1Q/SRP
- 3) IEEE 1722.1/AVDECC control
- 4) IEEE 802.1AS/gPTP
- 5) Compatible with Apple OS X devices, such as MacBooks and MacMini computers
- 6) Media clock per the AVnu specification
- 7) Hitless stream redundancy

Configuring the AOIP Merging Option Card

This appendix provides basic information about configuring the Merging ZMAN card by invoking the card's internal configuration application. The Merging card can be configured through a connection to the Ethernet AOIP Port using a browser on the Ravenna network and by using the Merging Aneman Windows application. Aneman is available for free download at:

<https://www.merging.com/support/downloads#aneman>

The *iAM-SUM* can be configured using its Front Panel controls or its web interface through its Management port. Details specific to the *iAM-SUM* can be found in Chapters 2 and 4 of this manual.

For a Quick Start, set the Source Select menu item on the Front Panel to AOIP to configure *iAM-SUM* to receive/source a Ravenna Stream over its AOIP port. The Source Select Menu control also allows selection of a range of channels in groups of 8 channels 1-8 ... 57-64. More details including definition of Presets and individual channel parameters are available by reference to other chapters of this manual.

The Merging Ravenna card runs specific firmware from Merging and augmented by Wohler for use within the *iAM-SUM*. The card will not function correctly if the user downloads and installs firmware from any source besides Wohler. The Wohler augmentation includes the ability to support 64 channels.

The Merging card is pre-configured to DHCP mode to obtain its IP address automatically from the Ravenna network. The Ravenna network should be a separate address space from the *iAM-SUM* Management port. For example, the *iAM-SUM* might be connected to a 10.11.11 subnet and the Ravenna network devices connected together on a 10.15.15 subnet. Aneman and a suitable browser must be resident on a host workstation on the same Ravenna subnet to access the Merging card. For this Appendix, the Ravenna network address will be referred to as <Ravenna subnet>. The Merging card address will then be <Ravenna subnet>.x where x is the specific address of the card on the subnet.

Power the *iAM-SUM* and verify the Ethernet connector LEDs are lit and/or blinking. It may take a few minutes for the card to be fully recognized on the Ravenna network after powering the *iAM-SUM*.

For Aneman access, the card parameters including its IP address should appear in a panel at the bottom of the screen. In Aneman, make sure Devices under Menu item View is enabled. Do not proceed until the card shows on Aneman. Right click

on that line and select Web Services: Advanced (or Ravenna) to bring up the Merging Ravenna configuration page. Also, the ICON of the card will appear in the main part of the Aneman screen. Double Clicking on the ICON also will load the Configuration screen.

For browser access, the URL is <Ravenna subnet>.x/advanced/index.html. This brings up the Merging Ravenna configuration page. Each tab is explained in the following sections.

Getting Started | General Settings

This tab is shown in the following figure.

Figure D-1: Getting Started | General Settings

General settings | PTP | Session sources | Session sinks | Ins/Outs | Debug

Audio Configuration

Sample rate: 48 kHz
Frame size (@1FS): 48 smpl AES67(1ms)

Session Sinks Global

Safety Playout Delay (@1FS): 0
SSM (requires IGMP v3):

Device Name

This is the unique zeroconf device name. Other devices see this device name.

Network Interface

Type: Zeroconf
Address: 169.254.80.179
Netmask: 255.255.0.0
Gateway: 0.0.0.0

Apply

Note: changing the network settings require a reboot of the device.

The elements of this tab are as follows:

1. **Device Name:** Enter a useful Device Name for the card, which will show up on other Ravenna devices on the subnet.
2. **Sample Rate:** (44100-48000- 88200-96000-176400-192000-352800-384000)
3. **Frame size (@1Fs):** current frame size (64 - AES67/48 - 32 -16 - 12 -6).
4. **Safety Playout Delay (@1Fs):** The value is described at 1Fs (44.1-48 kHz) in samples. For example, if the value is 10, the additional playout delay will be 20 at 2Fs (88.2-96 kHz), 40 at 4FS (176.4-192 kHz)
5. **SSM Source-Specific Multicast:** If needed, configure the network switch for IGMP V3.
6. **Network Interface:** Note the address of the card and its type (Zeroconf, DHCP, Static). (If necessary, the address can be changed to another type such as a Static address which must include a Network Mask and Gateway.)

Getting Started | PTP

This tab is shown in the following figure. This configuration page refers to how your Ravenna network is synchronized to clocks.

Figure D-2: Getting Started | PTP

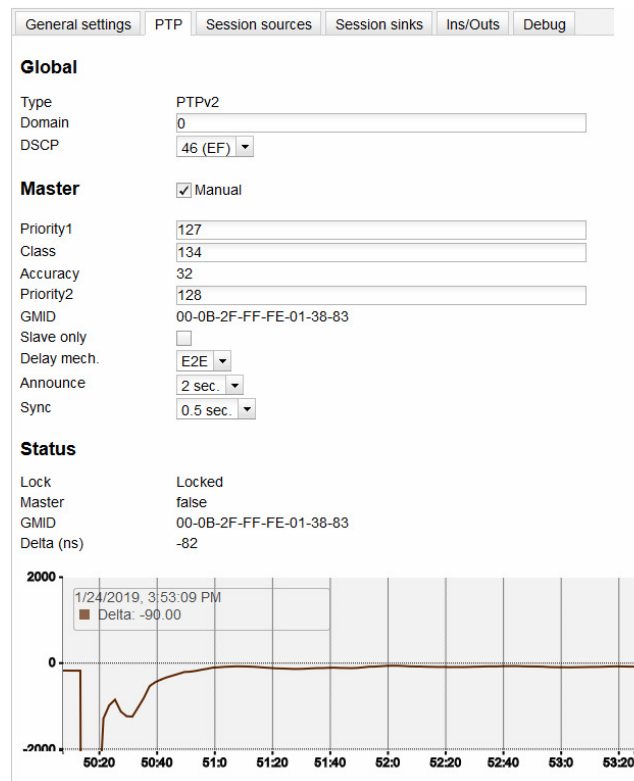

The elements of this tab are as follows:

- Global Settings:** The default value for PTP
 - Domain:** For the Merging Ravenna card this value is 0.
 - DSCP:** 46 for PTP AES67 or 48 for PTP Ravenna.
- Master:** To modify the PTP setting, you must first check the "Manual" checkbox.
 - Priority:** 1 is the main priority value.
 - Class:** This is the Device class. This value should not be modified.
 - Accuracy:** This field cannot be modified.
 - Priority 2:** This is only used if the other parameters do not allow electing a PTP master.
 - GMID:** This is the current GrandMasterID (PTP Master)
 - Slave only:** This forces the Merging device to always be PTP slave.
 - Delay Mech.:** This is PTP Profile related - E2E or P2P
 - Announce:** This is PTP Profile related - PTP announcement interval (1 - 2 - 4 - 8 -16 seconds)
 - Sync:** This is PTP Profile related (0.0625 - 0.125 - 0.25 - 0.5 seconds)

3. Status:

- a. **Lock:** This shows if the device is locked to PTP (Locked -Locking - Unlocked)
- b. **Master:** This is true or false for the current device.
- c. **GMID:** This is the current GrandMasterID (PTP Master)
- d. **Delta (ns):** This is the time delta between the device and the PTP master.

4. **Graph:** The graph is only active for slave devices and shows the device delta against Master PTP clock.

5. PTP Priority Value:

- a. 1 is the highest priority, 255 the lowest one.
- b. Merging card is by default using Priority 127 when set as PTP Master and 255 when PTP slave.

Getting Started | Session Sources

This tab defines which Streams are to be Sourced from this card. It is shown in the following figure.

Figure D-3: Getting Started | Session Sources

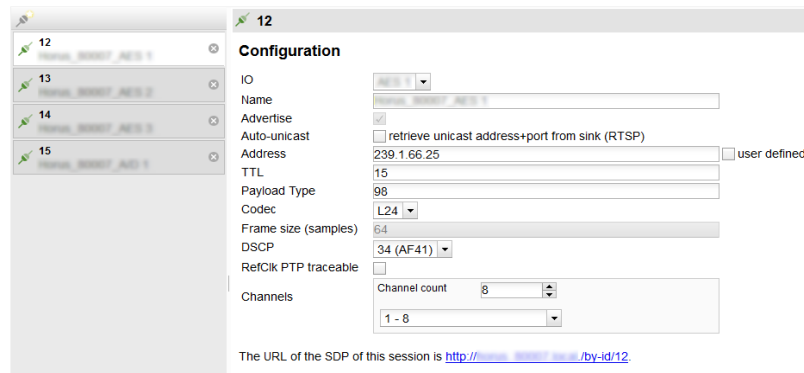

The elements of this tab are as follows:

1. **Create session button:** Create a new session sources by clicking on left ICON.
2. **IO:** Select the physical input (when applicable).
3. **Name:** This is the Source name.
4. **Advertise:** Check to enable source advertising on the network.
5. **Auto-unicast - (RTSP):** Check to automatically retrieve the sink (listener) IP address:port for unicast connection.
6. **Address:** This the stream's multicast address. Note that the user defined checkbox is activated automatically when entering a multicast address manually.
7. **TTL:** Time to Live (also called Hop Limit) - This value should not be modified.

8. **Payload type:** RTP Payload type - This value should not be modified.
9. **Codec:** The possible bit rate values are L24, L16, DSD64, DSD64_32, DSD128, DSD128_32, and DSD256. Note that these values are sampling rate dependent.
10. **Frame size (samples):** This the frame size of the current source.
11. **DSCP:** The audio DSCP should be set to 34 for RTP AES67 or 46 for RTP Ravenna.
12. **RefClk PTP traceable:** This feature is useful when you want to connect a stream through Internet (for example with two PTP Masters (GPS) at each location). This allows making connections with devices locked to different traceable PTP Masters. Refer also to Ignore RefClk GMID - accept source locked to any PTP master, on the Session Sinks tab.
13. **Channels:** This is the number of channels in the stream. The drop-down menu allows selection of specific channel range if the number of channels is less than 8.
14. **The URL of the SDP of this session:** This allows saving of the Session Description into a file, which is useful for specific third party devices if a manual SDP has to be provided.

Getting Started | Session Sinks

This tab defines streams which are sinked in this card. It is shown in the following figure.

Figure D-4: Getting Started | Session Sinks

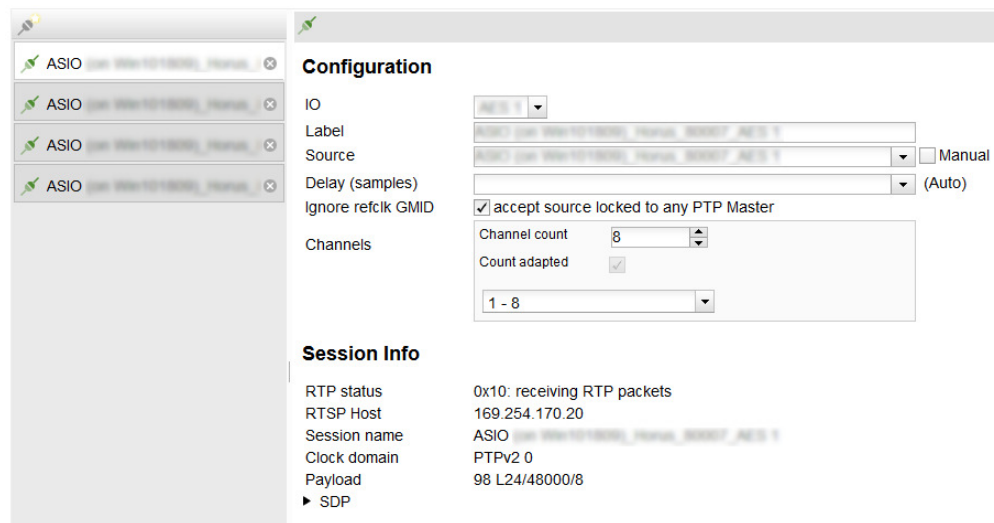

The elements of this tab are as follows:

1. **Create session button:** Create new session sinks by clicking on left ICON.
2. **IO:** Select the physical output (when applicable).
3. **Label:** This is the Sink name.
4. **Source:** This is a drop down menu to select a source (both sap and bonjour advertised sources are automatically listed).

5. **Manual:** This allows manual entry of an SDP.
6. **Delay (samples):** This sets the playback delay. 0 is automatic delay.
7. **Ignore RefClk GMID - accept source locked to any PTP master:** This feature is useful when you want to connect a stream through Internet (for example with two PTP Masters (GPS) at each location. This allows making of connections with devices locked to different traceable PTP Masters. See RefClk PTP traceable on the Session Sources tab.
8. **Channels:** Channel count: The drop-down menu allows selection of specific channel range if the number of channels is smaller than 8.

Getting Started | Session Info

1. **RTP Status:** The following bit positions indicate the connection status:
 - 0x10: receiving RTP packets (OK)
 - 0x01: wrong RTP sequence id
 - 0x02: wrong RTP SSRC
 - 0x04: wrong RTP payload type
 - 0x08: wrong RTP SAC
 - 0x20 stream has been muted
 - 0x40: Horus implementation - an incoming stream is muted

Important Note: The above error numbers are summed. For example, Stream Muted and Wrong Payload together are indicated by 0x24.

2. **Playout Delay:** This is the current playout delay on the selected sink in samples and ms.
3. **RTSP Host:** This is the connected source IP Session name: defined in SDP (usually the same as the source name)
4. **Clock Domain:** This is the PTP clock type and domain
5. **Payload:** Selections are Payload / Codec / Sampling Rate / Number of Channels
6. **SDP:** This displays detailed SDP information on the current stream.

Getting Started | Ins/Outs

This tab allows you to change the name of the specific Inputs and/or Outputs.

Figure D-5: Getting Started | Ins/Outs

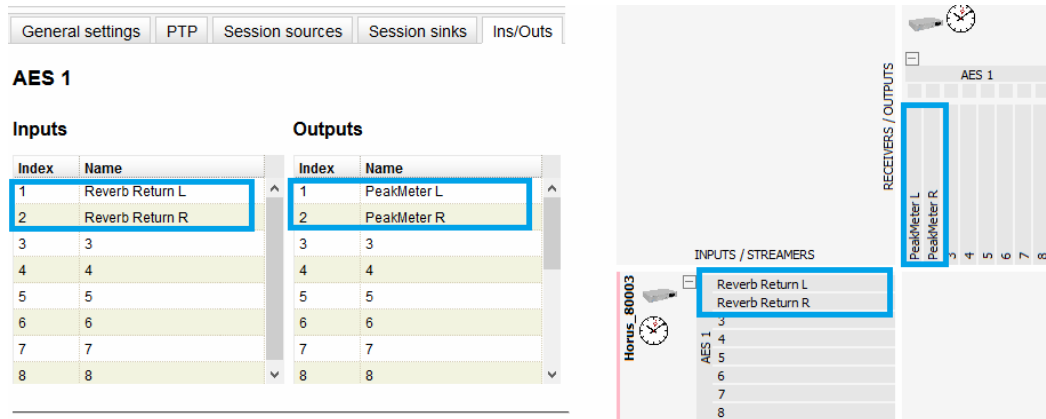

Getting Started | I/O Router

This page allows remapping of incoming channels to different internal channel assignments. For example, Stream channel 1 can be remapped to Merging card Channel 0, and so on.

Figure D-6: Getting Started | I/O Router

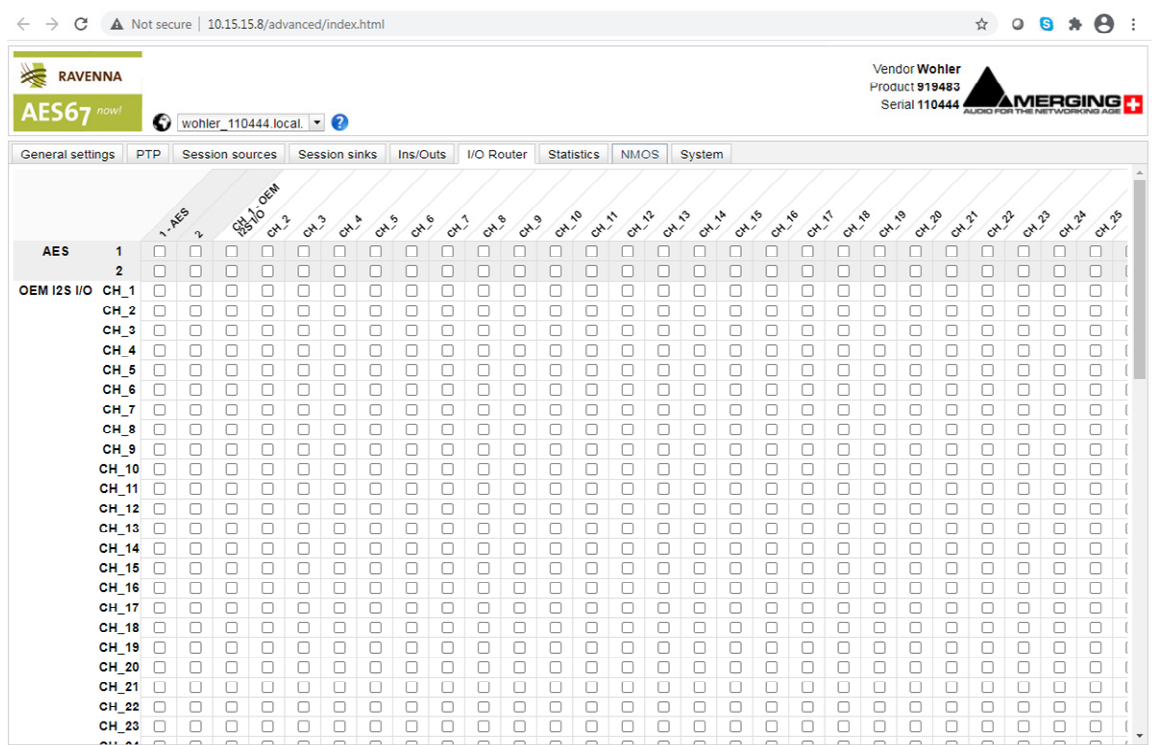

Operation:

Connecting Remote Source to Local Sink

This instruction assumes another Ravenna device is active on the network and sourcing a multicast stream. The Merging Configuration section for Session Sink controls how to configure the card to receive the stream and provide it to the IAM interface for display on meters and speakers, etc. The *iAM-SUM* must be set to receive AOIP from the Source Select Front Panel menu or a browser *iAM-SUM* GUI.

Ravenna Streams can contain up to 8 channels of information. The collections of channels in a specific Stream are termed Flows. For example, to source an SDI 16 channel signal might be accomplished by two Flows, each consisting of 8 channels. A stereo AES Flow consists of one Flow of two channels.

ZMAN Session Sinks

This assumes that 1 or more sources are present on the AOIP Ravenna network. Right Select Advanced on the entry for the Merging ZMAN device in Aneman. This brings up the browser page with tab set to General configuration GUI for the ZMAN card. This is shown in Figure D-1.

Use the following procedure:

1. Select the **Session Sinks** tab and use the **Create Session Sinks** icon (in the upper left corner) to see the available source Flows.
2. Create an entry on the left panel for each source Flow to be configured.
3. Select the desired Flow and set the number of channels in the Flow. Select the desired range to direct the Flow to the internal channels of the *iAM-SUM*.
4. Click the matrix, as shown in Figure D-7, to direct the incoming channels to the desired *iAM-SUM* channels.

For example, a 16 channel SDI source consists of two 8 channel Flows. One could be mapped to channels 1-8 and the other could be mapped to 9-16.

Notice that the Tab I/O Router duplicates the Session Sinks matrix and can be used to map channels from input source assignments to *iAM-SUM* channels also.

Input channels can be mapped to more than one *iAM-SUM* channel by selecting additional matrix elements to map input channels 1-8 to both 1-3 and 5-8.

Figure D-7: Session Sinks Tab

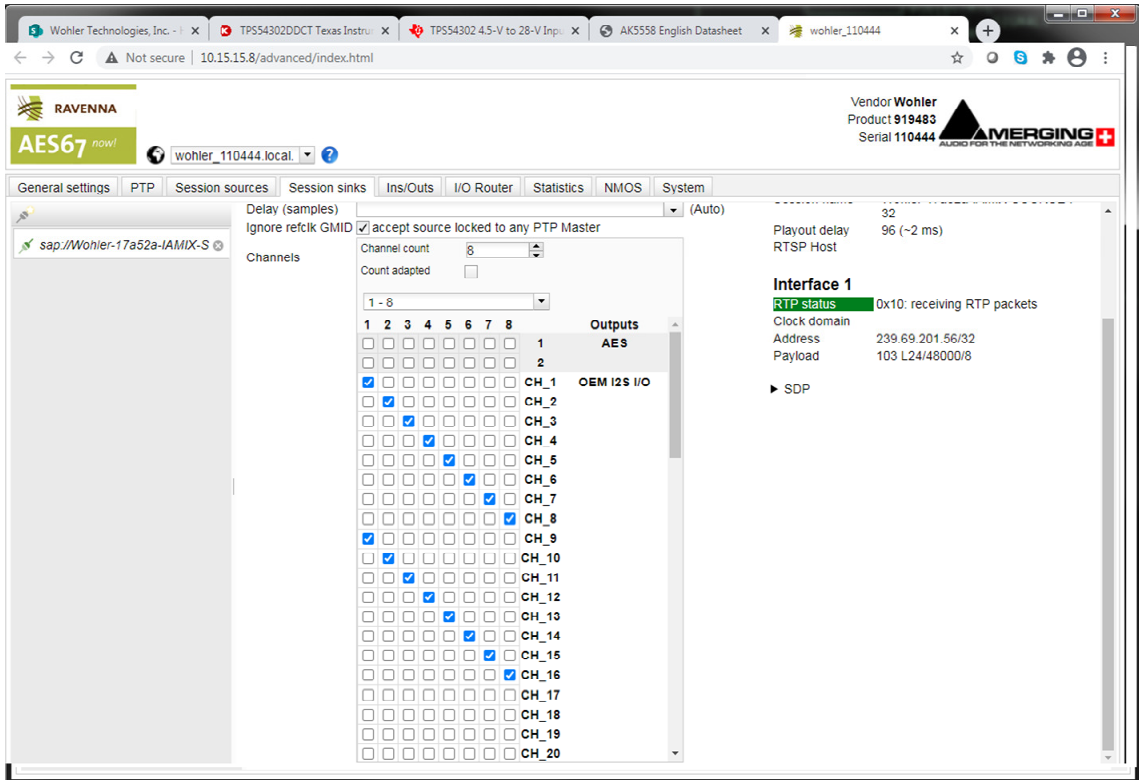

To avoid confusion if monitoring more than one Flow, especially if the various source Flows have overlapping channel numbers, use the matrix to direct Flows to higher channel ranges. For example, for monitoring 2 SDI sources (four 8 channel Flows), assign two flows to 1-8 and 9-16 and the next SDI signal to 17-24 and 25-32. Touch the *iAM-SUM* AOIP selection menu to select the proper range to monitor, up to 57-64.

Select **Apply** to enable the Sink process, which results in the meters and audio becoming available on the *iAM-SUM*.

ZMAN Session Sources

If the ZMAN card is to Source Flows, use the **Session Sources** tab. Refer to Figure D-8. The procedure is similar to defining Sinks with the additional step to provide the Flow a name to appear on other units in the network. Select the channel range with a maximum of 8 channels per Flow.

Figure D-8: Session Sources Tab

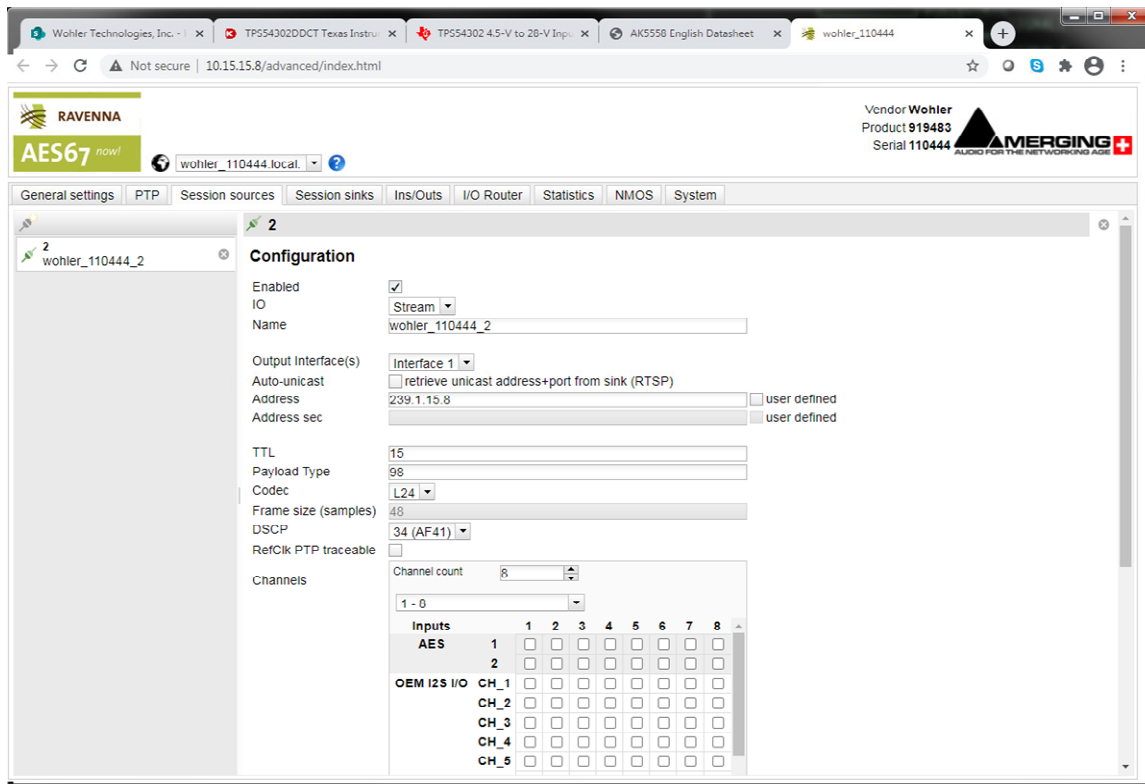

ZMAN Updating

The Zman card is pre-initialized with the correct Wohler firmware load. In case of future upgrades, use the following steps:

1. In Aneman, right click the ZMAN entry on the bottom Devices section, and select Maintenance Mode. This brings up a web page which prompts for the location of the Wohler provided upgrade file. The file should resemble the following:

firmware_1.1.7b43263_18Jun20.wohler

2. Select this file and click Open. On the web, select Update to install the firmware.
3. After successful completion, select Reboot to reboot the ZMAN card.
4. Close the web pages and return to Aneman to set up Sources and Sinks.

APPENDIX E: API Documentation

Introduction

This appendix discusses ways to use the Application Program Interface (API) to allow third party equipment to remotely access options and settings of the *iAM-SUM*. It includes specific code examples for commonly used requests. The API uses JavaScript Object Notation (JSON) as its communication language.

Follow the instructions in the **First Time IP Assignments** section of Chapter 4 to achieve the required network connection.

API: Presets

1. GET Active Presets

Method: GET

/api/cf/presets/current

Example Response:

```
{
  "serial_number": "123456",
  "model": "SUM",
  "version": 1.3,
  "name": "",
  "result": {
    "group": {
      "Id": 1,
      "Name": "G1"
    },
    "preset": {
      "Data": null,
      "Favorite": 0,
      "Id": 2,
      "Name": "SDI_Manual"
    }
  }
}
```

2. GET Preset Configuration

Method: GET

/api/cf/presets/<int:preset ID>

Example Response:

```
{
  "error": null,
  "params": {
    "PresetId": 2
  },
  "result": {
    "GroupId": 1,
    "Favorite": 0,
    "Data": {
      "Name": {
        "Preset": "SDI_Autofill",
        "Program": "",
        "Group": "newGrpNameSdi"
      },
      "MeterSet": {
        "6": {
          "Speaker": "Right",
          "DelayMs": 0,
          "Source": {
            "Slot": 0,
            "Cage": 2,
            "Type": "SDI",
            "ConnectorType": "BNC",
            "Channel": 6,
            "InputNo": 1,
            "InputIndex": 1
          },
          "VolumeDb": 0
        },
        "8": {
          "Speaker": "Right",
          "DelayMs": 0,
          "Source": {
            "Slot": 0,
            "Cage": 2,
            "Type": "SDI",
            "ConnectorType": "BNC",
            "Channel": 8,
            "InputNo": 1,
            "InputIndex": 1
          }
        }
      }
    }
  }
}
```

```

    },
    "VolumeDb": 0
  },
  "13": {
    "Speaker": "Left",
    "DelayMs": 0,
    "Source": {
      "Slot": 0,
      "Cage": 0,
      "Type": "None",
      "ConnectorType": "None",
      "Channel": 0,
      "InputNo": 0,
      "InputIndex": 0
    },
    "VolumeDb": 0
  },
  "14": {
    "Speaker": "Right",
    "DelayMs": 0,
    "Source": {
      "Slot": 0,
      "Cage": 0,
      "Type": "None",
      "ConnectorType": "None",
      "Channel": 0,
      "InputNo": 0,
      "InputIndex": 0
    },
    "VolumeDb": 0
  },
  "3": {
    "Speaker": "Left",
    "DelayMs": 0,
    "Source": {
      "Slot": 0,
      "Cage": 2,
      "Type": "SDI",
      "ConnectorType": "BNC",
      "Channel": 3,
      "InputNo": 1,
      "InputIndex": 1
    },
    "VolumeDb": 0
  },
  "9": {
    "Speaker": "Left",
    "DelayMs": 0,
    "Source": {
      "Slot": 0,
      "Cage": 0,

```

```

        "Type": "None",
        "ConnectorType": "None",
        "Channel": 0,
        "InputNo": 0,
        "InputIndex": 0
    },
    "VolumeDb": 0
},
"10": {
    "Speaker": "Right",
    "DelayMs": 0,
    "Source": {
        "Slot": 0,
        "Cage": 0,
        "Type": "None",
        "ConnectorType": "None",
        "Channel": 0,
        "InputNo": 0,
        "InputIndex": 0
    },
    "VolumeDb": 0
},
"5": {
    "Speaker": "Left",
    "DelayMs": 0,
    "Source": {
        "Slot": 0,
        "Cage": 2,
        "Type": "SDI",
        "ConnectorType": "BNC",
        "Channel": 5,
        "InputNo": 1,
        "InputIndex": 1
    },
    "VolumeDb": 0
},
"4": {
    "Speaker": "Right",
    "DelayMs": 0,
    "Source": {
        "Slot": 0,
        "Cage": 2,
        "Type": "SDI",
        "ConnectorType": "BNC",
        "Channel": 4,
        "InputNo": 1,
        "InputIndex": 1
    },
    "VolumeDb": 0
},
"12": {

```

```

    "Speaker": "Right",
    "DelayMs": 0,
    "Source": {
        "Slot": 0,
        "Cage": 0,
        "Type": "None",
        "ConnectorType": "None",
        "Channel": 0,
        "InputNo": 0,
        "InputIndex": 0
    },
    "VolumeDb": 0
},
"11": {
    "Speaker": "Left",
    "DelayMs": 0,
    "Source": {
        "Slot": 0,
        "Cage": 0,
        "Type": "None",
        "ConnectorType": "None",
        "Channel": 0,
        "InputNo": 0,
        "InputIndex": 0
    },
    "VolumeDb": 0
},
"7": {
    "Speaker": "Left",
    "DelayMs": 0,
    "Source": {
        "Slot": 0,
        "Cage": 2,
        "Type": "SDI",
        "ConnectorType": "BNC",
        "Channel": 7,
        "InputNo": 1,
        "InputIndex": 1
    },
    "VolumeDb": 0
},
"2": {
    "Speaker": "Right",
    "DelayMs": 0,
    "Source": {
        "Slot": 0,
        "Cage": 2,
        "Type": "SDI",
        "ConnectorType": "BNC",
        "Channel": 2,
        "InputNo": 1,
    }
}

```



```

        "InputIndex": 1
    },
    "VolumeDb": 0
},
"15": {
    "Speaker": "Left",
    "DelayMs": 0,
    "Source": {
        "Slot": 0,
        "Cage": 0,
        "Type": "None",
        "ConnectorType": "None",
        "Channel": 0,
        "InputNo": 0,
        "InputIndex": 0
    },
    "VolumeDb": 0
},
"1": {
    "Speaker": "Left",
    "DelayMs": 0,
    "Source": {
        "Slot": 0,
        "Cage": 2,
        "Type": "SDI",
        "ConnectorType": "BNC",
        "Channel": 1,
        "InputNo": 1,
        "InputIndex": 1
    },
    "VolumeDb": 0
},
"16": {
    "Speaker": "Right",
    "DelayMs": 0,
    "Source": {
        "Slot": 0,
        "Cage": 0,
        "Type": "None",
        "ConnectorType": "None",
        "Channel": 0,
        "InputNo": 0,
        "InputIndex": 0
    },
    "VolumeDb": 0
}
},
"DolbyDecoderConf": null,
"Clusters": [
    {
        "Name": "Stereo 2.0 #1",

```

```

        "NumberOfMeters": 2,
        "FirstMeter": 1,
        "Type": "Stereo",
        "MuteOnPresetRecall": true
    },
    {
        "Name": "Stereo 2.0 #2",
        "NumberOfMeters": 2,
        "FirstMeter": 3,
        "Type": "Stereo",
        "MuteOnPresetRecall": true
    },
    {
        "Name": "Stereo 2.0 #3",
        "NumberOfMeters": 2,
        "FirstMeter": 5,
        "Type": "Stereo",
        "MuteOnPresetRecall": true
    },
    {
        "Name": "Stereo 2.0 #4",
        "NumberOfMeters": 2,
        "FirstMeter": 7,
        "Type": "Stereo",
        "MuteOnPresetRecall": true
    },
    {
        "Name": "Stereo 2.0 #5",
        "NumberOfMeters": 2,
        "FirstMeter": 9,
        "Type": "Stereo",
        "MuteOnPresetRecall": true
    },
    {
        "Name": "Stereo 2.0 #6",
        "NumberOfMeters": 2,
        "FirstMeter": 11,
        "Type": "Stereo",
        "MuteOnPresetRecall": true
    },
    {
        "Name": "Stereo 2.0 #7",
        "NumberOfMeters": 2,
        "FirstMeter": 13,
        "Type": "Stereo",
        "MuteOnPresetRecall": true
    },
    {
        "Name": "Stereo 2.0 #8",
        "NumberOfMeters": 2,
        "FirstMeter": 15,

```

```

        "Type": "Stereo",
        "MuteOnPresetRecall": true
    }
],
"DolbyInputSource": {
    "Slot": 0,
    "Cage": 0,
    "Type": "None",
    "ConnectorType": "None",
    "InputNo": 0,
    "Pair": 0
},
"VideoSource": {
    "Slot": 0,
    "Type": "None",
    "InputNo": 0
},
"ConnectorTypeOptions": {
    "0": {
        "MADI": {
            "1": {
                "MADI": {
                    "ConnectorTypeOption": "BNC"
                }
            }
        }
    }
},
"ApplyCdlb": true,
"ApplyCor": true,
"SpeakerDelayMs": 0,
"AudioOutputRouting": null,
"SystemClockSource": {
    "Slot": 0,
    "Cage": 2,
    "Type": "SDI",
    "ConnectorType": "BNC",
    "InputNo": 1,
    "Pair": 1
},
"PhasePairs": 254,
"ApplyCpi": true,
"DolbyDetection": {
    "NonAudio": "Enabled",
    "PaHeader": "Enabled"
},
"ApplyDZMeterScreen": false
},
"PresetId": 2,
"PresetName": "SDI_Autofill",
"GroupName": "newGrpNameSdi"

```

```
}  
}
```

3. GET list of groups/presets

Method: GET

/api/cf/groups

Example Response:

```
{  
  "params": null,  
  "error": null,  
  "result": [  
    {  
      "Presets": [  
        {  
          "Favorite": 0,  
          "Id": 3,  
          "Name": "SDI_Autofill"  
        },  
        {  
          "Favorite": 0,  
          "Id": 2,  
          "Name": "SDI_Manual"  
        }  
      ],  
      "Id": 1,  
      "Name": "G1"  
    }  
  ]  
}
```

4. GET to recall the preset

Method: GET

api/op/presets/<int:presetID>/activate

Example Response:

```
{  
  "params": {  
    "PresetId": 2  
  },  
  "error": null,  
  "result": {  
    "GroupId": 1,  
    "PresetName": "SDI_Manual",  
    "GroupName": "G1",  
  }  
}
```

```
        "PresetId": 2
      }
    }
  }
```

5. POST to delete the group

Method: POST

api/op/group/<int:groupID>/delete

Example Response:

```
{
  "params": {
    "GroupId": 2
  },
  "error": null,
  "result": {
    "GroupId": 2
  }
}
```

6. POST to delete the preset

Method: POST

api/op/preset/<int:presetID>/delete

Example Response:

```
{
  "params": {
    "PresetId": 1
  },
  "error": null,
  "result": {
    "PresetId": 1
  }
}
```

7. POST to rename group

Method: POST

/api/op/group/<int:groupID>/newGrpNameSdi/rename

Example Response:

```
{
  "params": {
    "GroupId": 1,
    "GroupName": "newGrpNameSdi"
  },
}
```

```
    "error": null,
    "result": {
      "GroupId": 1,
      "GroupName": "newGrpNameSdi"
    }
  }
}
```

8. POST to rename preset

Method: POST

/api/op/preset/<int:presetID>/newPresetNameTest/rename

Example Response:

```
{
  "error": null,
  "params": {
    "PresetId": 1,
    "PresetName": "newPresetNameTest"
  },
  "result": {
    "PresetId": 1,
    "PresetName": "newPresetNameTest"
  }
}
```

9. POST to set preset as Favorite

Method: POST

/api/op/preset/<int:presetID>/<favoriteVal>/favorite

Example Response:

```
{
  "error": null,
  "params": {
    "PresetId": 4,
    "Favorite": 1
  },
  "result": {
    "PresetId": 4,
    "Favorite": 1
  }
}
```

10. Source Select

Method: POST

/api/op/sourceselect

1. Body content for SDI/SMPTE-2022-6/ SMPTE-2110

```
{  
  "SourceType": "<String: SDI Input Source>",  
  "ChannelGroup": <Int: 1-2>  
}
```

Note: Allowed SDI input sources are:

```
"Bnc-1.Sdi",  
"Bnc-2.Sdi",  
  
"Sfp-1.Sdi",  
"Sfp-1.Smpte2022",  
"Sfp-1.Smpte2110",
```

e.g.

```
{  
  "SourceType": "Sfp-1.Smpte2022",  
  "ChannelGroup": 2  
}
```

2. Body content for MADI

```
{  
  "SourceType": <String: MADI Input Source>,  
  "ChannelGroup": <Int: 1-8>  
}
```

Note: Allowed MADI input sources are

```
"Madi.Coax" and  
"Madi.Optical"
```

ChannelGroup 1 => Channels 1-8 and

ChannelGroup 2 => Channels 9-16 and so on

e.g.

```
{  
  "SourceType": "Madi.Coax",  
  "ChannelGroup": 6  
}
```

3. Body content for Analog

```
{  
  "SourceType": "Analog.XLR"  
}
```

```
{
  "SourceType": "Analog.DB25"
}
```

4. Body content for Aes

```
{
  "SourceType": "Aes"
}
```

5. Body content for Aoip

```
{
  "SourceType": "Aoip",
  "ChannelGroup": <Int: 1-8>
}
```

Note: ChannelGroup 1 => Channels 1-8 and
ChannelGroup 2 => Channels 9-16 and so on

6. Body content for TOSLINK

```
{
  "SourceType": "Toslink"
}
```

Example Response:

```
{
  "unit_name": "",
  "model": "iAM-SUM",
  "api_version": 1,
  "message": "Input Source Toslink has been applied successfully",
  "serial_number": "123456",
  "status": 200
}
```