

# TASCAM

D01247020A

# US-16x08

## USB2.0 Audio Interface/Mic Preamp

**Reference Manual**

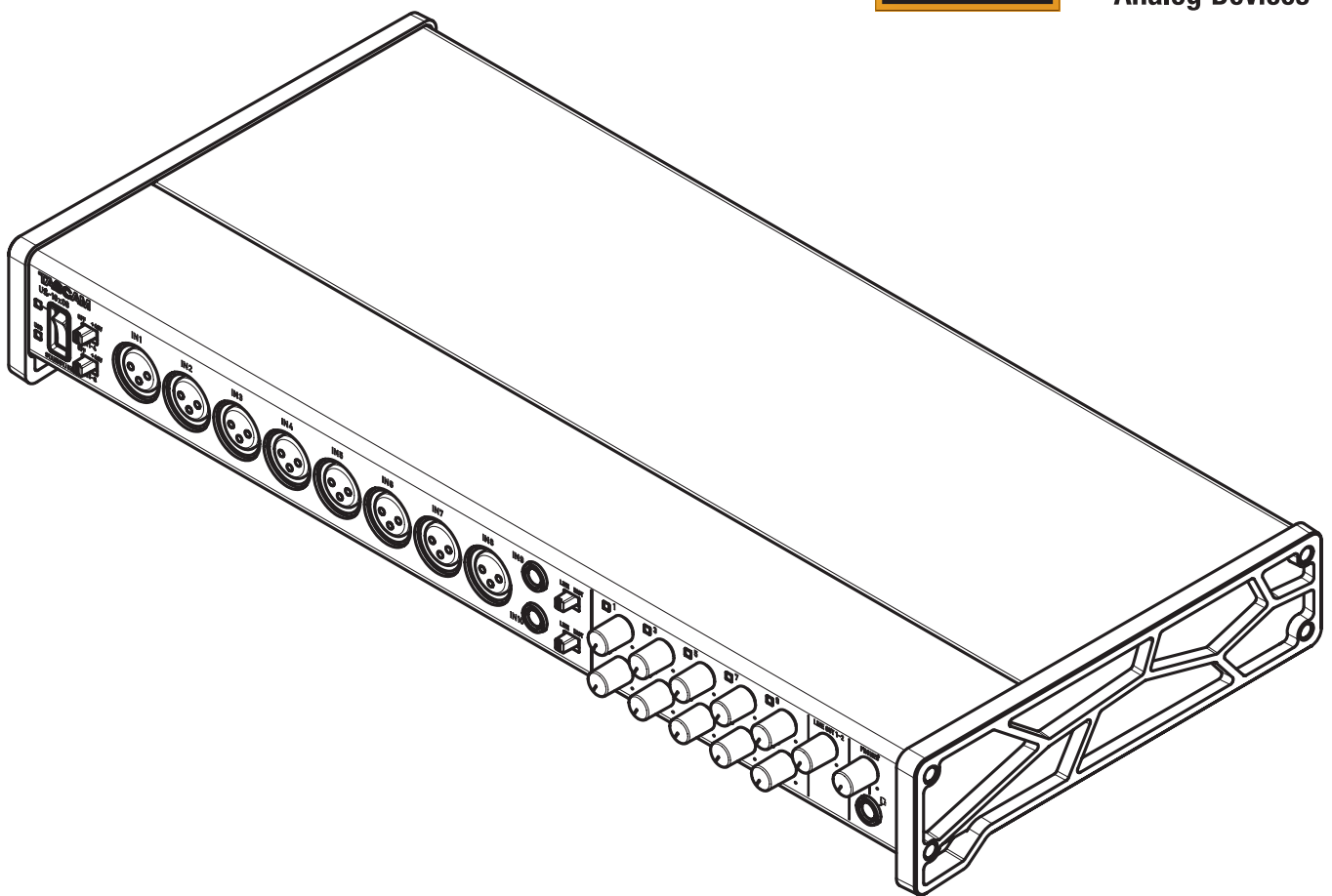

Before connecting this unit to a computer, you must download and install a dedicated driver.

# Contents

<b>1 – Introduction .....</b>	<b>3</b>	Windows 8 .....	23
Features .....	3	Windows 7 .....	23
Conventions used in this manual .....	3	Mac OS X and iTunes.....	24
<b>2 – Names and functions of parts .....</b>	<b>4</b>	iOS .....	24
Front panel .....	4	<b>9 – MIDI Implementation Chart .....</b>	<b>25</b>
Rear panel .....	5	<b>10 – Troubleshooting .....</b>	<b>26</b>
<b>3 – Installation .....</b>	<b>6</b>	Troubleshooting .....	26
System requirements.....	6	<b>11 – Specifications .....</b>	<b>28</b>
Windows.....	6	Specifications .....	28
Mac OS X.....	6	Ratings .....	28
iOS devices .....	6	Analog inputs .....	28
Supported audio drivers .....	6	Analog outputs .....	28
Installing the driver and Settings Panel .....	6	Control input/output ratings .....	28
Installing the driver and Settings Panel for		Audio performance .....	29
Windows.....	6	Computer system requirements .....	29
Installing the Mac OS X Settings Panel.....	7	Windows.....	29
Uninstalling the driver and Settings Panel .....	9	Mac OS X.....	29
Automatic launching of the Settings Panel.....	9	iOS devices .....	29
<b>4 – Preparation.....</b>	<b>10</b>	Supported audio drivers .....	29
Attaching the rackmount angles .....	10	General .....	29
Connecting the power .....	10	Dimensional drawings .....	30
<b>5 – Connections.....</b>	<b>11</b>	Block diagrams.....	31
Examples of connections with other equipment..	11	Level diagrams .....	32
Computer connections.....	12		
Audio connections .....	12		
Microphones.....	12		
Guitar .....	12		
Electronic and audio devices and other			
equipment.....	12		
Analog record players .....	12		
Monitor speakers.....	12		
Headphones.....	12		
MIDI connections.....	12		
Connecting with iOS devices.....	12		
<b>6 – Using the Settings Panel .....</b>	<b>13</b>		
Opening the Settings Panel .....	13		
Settings Panel screen .....	13		
MIXER page .....	14		
INTERFACE page .....	17		
OUTPUT SETTING page.....	18		
Settings Panel pull-down menus.....	19		
View menu.....	19		
SceneMemory menu .....	20		
<b>7 – Mic Preamp Mode .....</b>	<b>22</b>		
Using the unit as a standalone mic preamp.....	22		
<b>8 – Application Guide .....</b>	<b>23</b>		
Windows Media Player.....	23		

---

## Features

---

- Built-in Ultra-HDDA mic preamps with discrete construction that achieves –125dBu EIN
- Support for direct guitar input
- Input specifications that can handle the sound pressures of drum recording easily
- 8 XLR inputs that support +48V phantom power and 6 TRS inputs that can be switched between –10 dBV and +4 dBu
- Standalone mic preamp use also supported
- Support for high resolution recording formats up to 24-bit/96kHz
- USB 2.0 computer connection
- Advanced DSP mixer with four-band equalizer and compressor on each channel
- Driver software that can be installed without connecting the unit
- Angled design provides excellent usability on a desktop
- Tough metal casing can endure even hard use
- Separate controls for line and headphones output volumes
- Supports connection with an iPad or other iOS device
- Operation confirmed with major DAW software (Sonar, ProTools, Cubase, Live, Studio One, GarageBand)
- MIDI input and output enable connection with keyboards and other MIDI devices
- Rack mount adapters and hex key included
- Support for Windows and Mac
- High 56dB input level range supports dynamic mic input
- Balanced analog TRS output jacks suitable for connection to powered monitors
- Standard stereo TRS headphones jack with 70mW per channel output
- Low latency monitoring through the DSP mixer
- Patch bay allows outputs to be assigned freely
- Scene memories can store DSP mixer settings (up to 10 scenes can be stored and renamed)
- 8 balanced analog TRS output jacks
- AC adapter included

### Note about computer operation

If you are unsure about anything related to the basic operation of a computer when it is mentioned in an explanation in this manual, please refer to the computer operation manual.

This product incorporates a Blackfin® processor made by Analog Devices, Inc.
--

---

## Conventions used in this manual

---

The following conventions are used in this manual.

- Switches, connectors and other physical parts of this unit are written using a bold font like this: **PHONES** knob.
- Information shown on the computer display is written like this “OK”.
- As necessary, additional information is provided under TIP, NOTE and CAUTION headings.

### TIP

*These are tips about how to use the unit.*

### NOTE

*These provide additional explanations and describe special cases.*

### CAUTION

*Failure to follow these instructions could result in injury, damage to equipment or lost recording data, for example.*

# 2 – Names and functions of parts

## Front panel

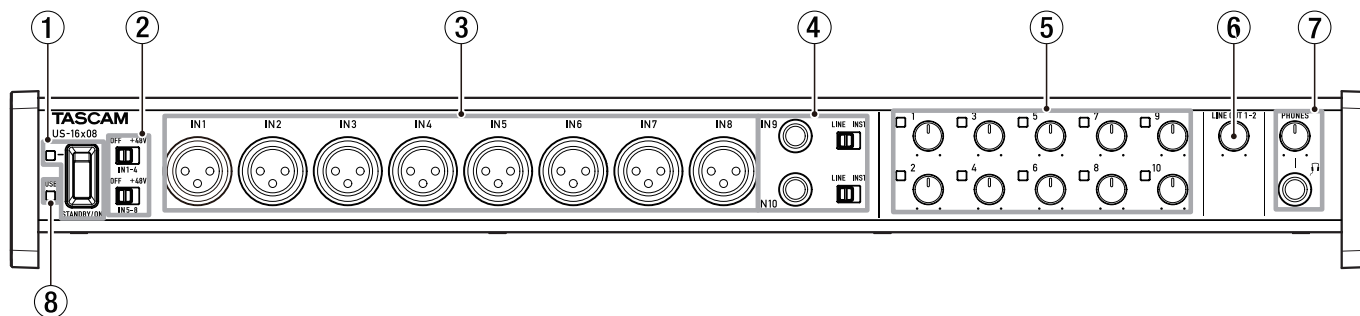

### ① STANDBY/ON switch and indicator

Press to turn the unit on and to put it into standby. The **STANDBY/ON** indicator lights green when the unit is on.

### ② Phantom power switches

Use these switches to provide **+48V** phantom power to the IN 1–4 and IN 5–8 jacks.

These switches each turn phantom power on/off for 4 channels at a time. Phantom power is supplied when a switch is set to **+48V**.

### CAUTION

- *Before using these switches to turn phantom power on (+48V) or OFF, set the PHONES and LINE OUT 1-2 knobs to their minimum values. Failure to do so could cause a loud noise that might damage other equipment or harm people.*
- *Do not connect or disconnect mics when a switch is set to +48V.*
- *Do not supply phantom power to an unbalanced dynamic mic.*
- *Supplying phantom power to some ribbon mics will break them. If you are unsure, do not supply phantom power to a ribbon mic.*

### ③ IN 1-8 (BALANCED) jacks

These are analog XLR input jacks. You can adjust their input gains with the gain knobs.

(1: GND, 2: HOT, 3: COLD)

### ④ IN 9-10 (balanced/unbalanced) jacks and LINE/INST switches

These are standard analog TRS input jacks.

The **LINE/INST** switches enable support for both line input, including audio equipment and keyboards, and high impedance input, including direct input of guitars.

You can adjust their input gains with the gain knobs.

(Tip: HOT, Ring: COLD, Sleeve: GND)

### ⑤ Gain knobs and overload indicators

Use the 1–10 gain knobs to adjust the gain of **IN 1-10** independently.

These can set the gain for **IN 1-8** between  $-12$  dBu and  $-68$  dBu and for **IN 9-10** between  $+4$  dBu and  $-42$  dBu (between  $-12$  dBV and  $-57$  dBV during guitar input).

The overload indicators to the upper left of each of the 1–10 gain knobs light just before an input is about to distort (when the signal exceeds  $-1$  dBFS).

### ⑥ LINE OUT 1-2 knob

Use this knob to adjust the output level of the **LINE OUT 1-2** jacks on the back of the unit.

### ⑦ PHONES jack and knob

Use this standard stereo jack to connect stereo headphones. The sound output is the same as the signals output from the **LINE OUT 1-2** jacks.

Use the **PHONES** knob to adjust the headphone output level.

### ⑧ USB indicator

This lights orange when the USB connection is working.

### CAUTION

*Before connecting headphones, minimize the volume with the PHONES knob. Failure to do so might cause sudden loud noises, which could harm your hearing or result in other trouble.*

## 2 – Names and functions of parts

### Rear panel

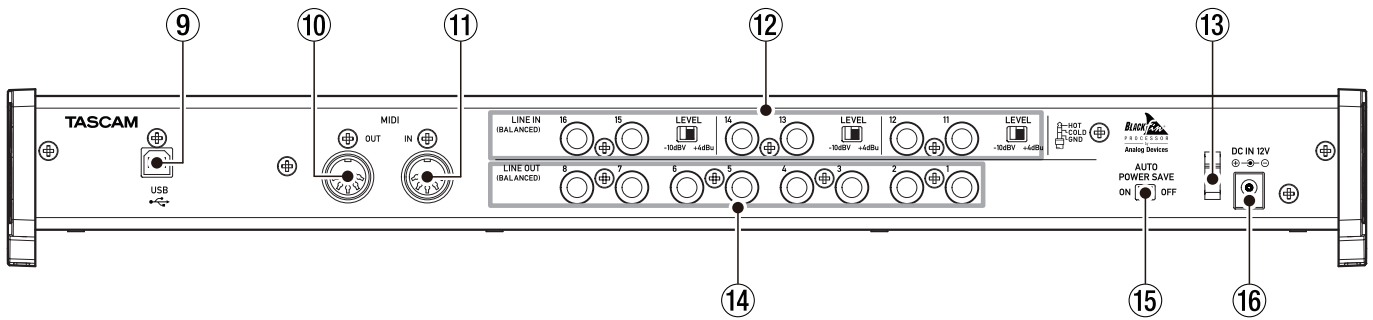

#### 9 USB port

Use the included USB cable to connect the unit to a computer or iOS device (supports USB 2.0).

#### CAUTION

- *USB 1.1 is not supported.*
- *When connected to a USB 3.0 port, it will function in High Speed mode equivalent to USB 2.0 (480 Mbps maximum).*

#### 10 MIDI OUT connector

This 5-pin DIN is a standard MIDI output connector. This outputs MIDI signals.

#### 11 MIDI IN connector

This 5-pin DIN is a standard MIDI input connector. Use this to input MIDI signals.

#### 12 LINE IN 11-16 (balanced) jacks and switches

These are standard TRS line input jacks. Use the LEVEL switches to set the nominal level to  $-10$  dBV or  $+4$  dBu. (Tip: HOT, Ring: COLD, Sleeve: GND)

#### NOTE

*The input gain cannot be adjusted for these jacks.*

#### 13 Cord holder

Attach the cord of the included AC adapter here to prevent the plug from becoming disconnected.

#### 14 LINE OUT 1-8 (balanced) jacks

These are standard TRS analog line output jacks. Their nominal output levels are  $+4$  dBu. (Tip: HOT, Ring: COLD, Sleeve: GND)

#### 15 AUTO POWER SAVE switch

This can be set to have the unit turn itself off (start standby) automatically if no input signal (above  $-60$  dBFS) has been detected for 30 minutes when operating in mic preamp mode.

#### CAUTION

*If you want to turn the unit on again after it has turned itself off (entered standby) automatically using this function, set the **STANDBY/ON** switch to **STANDBY** once, wait at least 8 seconds and then set it to **ON** again.*

#### 16 DC IN 12V connector

Connect the included AC adapter (GPE248-120200-Z) here.

# 3 – Installation

## System requirements

Check the TEAC Global Site (<http://teac-global.com/>) for the latest information about supported operating systems.

### Windows

#### ■ Supported operating systems

Windows 8 (including 8.1) 32-bit  
Windows 8 (including 8.1) 64-bit  
Windows 7 32-bit SP1 or later  
Windows 7 64-bit SP1 or later

#### ■ Computer hardware requirements

Windows computer with a USB 2.0 or USB 3.0 port

#### ■ CPU/processor speed

2 GHz or faster dual core processor (x86)

#### ■ Memory

2 GB or more

#### ■ Display resolution

Display with 1280x800 resolution

#### CAUTION

*Operation of this unit was confirmed using standard computers that meet the above requirements. This does not guarantee operation with all computers that meet the above requirements. Even computers that meet the same system requirements might have processing capabilities that differ according to their settings and other operating conditions*

#### NOTE

*If noise occurs, please set your computer's power options to "High Performance".*

### Mac OS X

#### ■ Supported operating systems

OS X Yosemite (10.10 or later)  
OS X Mavericks (10.9.1 or later)  
OS X Mountain Lion (10.8.4 or later)

#### ■ Computer hardware requirements

Apple Mac computer with a USB 2.0 or USB 3.0 port

#### ■ CPU/processor speed

2 GHz or faster dual core processor

#### ■ Memory

2 GB or more

#### ■ Display resolution

Display with at least 1280x800 resolution

### iOS devices

Apple devices running iOS 7 or later

## Supported audio drivers

Windows: ASIO2.0, WDM, MIDI

Mac: Core Audio, Core MIDI

## Installing the driver and Settings Panel

To use this unit with a Windows computer, a driver and Settings Panel must be installed on it. To use this unit with a Mac, a driver does not need to be installed, but the Settings Panel must be installed in order to use the DSP mixer functions.

Download the latest driver and Settings Panel for the operating system you are using from the TEAC Global Site (<http://teac-global.com/>).

- When you install the driver on a Windows computer, the Settings Panel will be installed at the same time.
- Only the Settings Panel needs to be installed on a Mac. This unit can be operated with the standard Mac OS driver, so there is no need to install a driver.
- When using this unit with an iOS device, the standard OS driver will be used, so there is no need to install a driver or Settings Panel.

#### CAUTION

*Restarting the computer might be necessary after installation or uninstallation completes. Save your data and conduct other necessary steps in other applications before quitting them.*

## Installing the driver and Settings Panel for Windows

#### NOTE

- Complete installation of the driver on the computer before connecting the unit to it with the USB cable. If you already connected the unit using the USB cable before installing the driver, and the Found New Hardware Wizard launched on the computer, close the Wizard and disconnect the USB cable.

#### ■ Installation procedures

1. Download the latest driver for the operating system you are using from the TEAC Global Site (<http://teac-global.com/>) and save it on the computer to be used with the unit.
2. Open the saved driver (zip file) on, for example, the computer desktop.
3. Double-click the "US-16x08\_Installer.exe" file in the folder that appears after uncompression to automatically launch the installation software.

#### CAUTION

*If you open a zip file without decompressing it and double-click the "US-16x08\_Installer.exe" file in the folder that opens, installation will not start. Right-click the zip file and select "Extract All", for example, to decompress it and then try again.*

4. When a "Security Warning" or "User Account Control" screens appear, click the "Yes" button.

# 3 – Installation

5. Next, select a language and click the “OK” button.

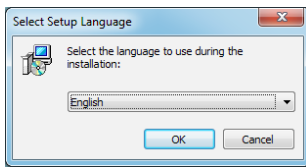

6. When the Setup Wizard screen appears, click the “Next” button.

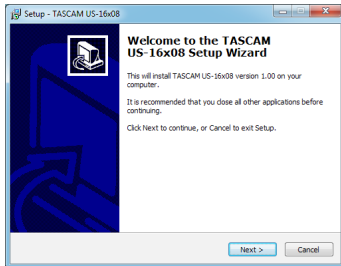

7. Read the contents of the License Agreement, and select “Agree (A)” if you agree to the terms. Then, click the “Next” button.

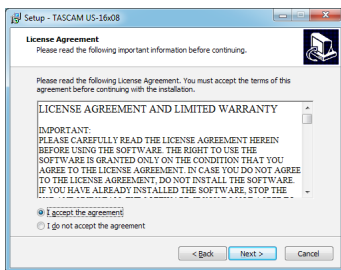

8. Next, click the “Install (I)” button.

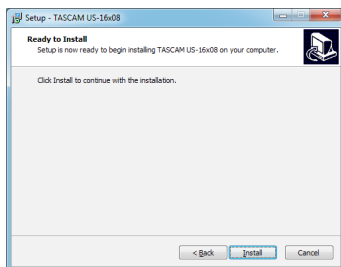

9. When the Install Wizard screen appears, click the “Next (N)” button.

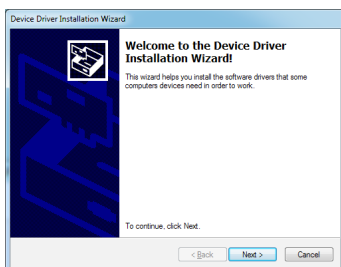

10. Next, click the “Install (I)” button to start installation.

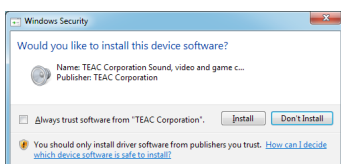

11. Click the “Finish” button when the screen below appears.

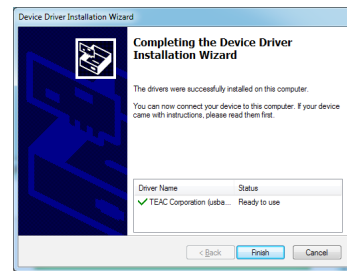

12. The following screen appears when installation has completed. Click the “Finish (F)” button.

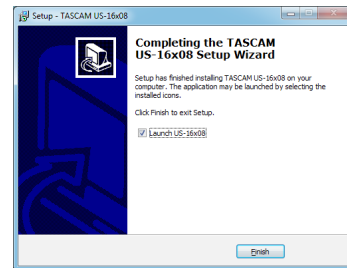

The installer will quit and the Settings Panel will launch.

## CAUTION

- When installing the driver, a warning might appear with a message such as, “The software you are installing for the hardware has not passed Windows Logo testing to verify its compatibility with Windows.” If this message appears, click “Continue Anyway” to proceed with the installation.

## Installing the Mac OS X Settings Panel

### NOTE

- Install the Settings Panel on the computer before connecting the unit to it with the USB cable. If the unit is connected by the USB cable, cancel driver installation and disconnect it before starting driver installation again.
- During Settings Panel installation a warning message like this might appear: “US-16x08.pkg can't be opened because it was not downloaded from the Mac App Store.” If a message like this appears, follow the instructions in “Working with Gatekeeper” on page 8 in this manual and then proceed with the installation.

### Installation procedures

1. Download the latest Settings Panel for the operating system you are using from the TEAC Global Site (<http://teac-global.com/>) and save it on the computer to be used with the unit.
2. Double-click “US-16x08\_X.XX.dmg”, which is the saved disk image file for the Settings Panel, and double-click “US-16x08.pkg” inside the folder that opens.



### NOTE

Depending on the computer's settings, the downloaded zip file might not have opened automatically. In this case, open the zip file first and then double-click the disk image file.

# 3 – Installation

3. When the installer starts, click the “Continue” button.

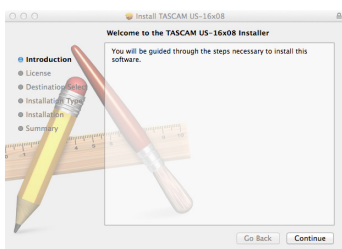

4. Next, select the desired language and click the “Continue” button.

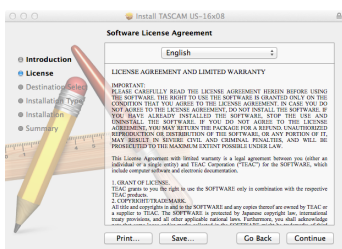

5. Click the “Read License” button and check the contents of the Software License Agreement. If you agree to the contents of the license, click “Agree”. Then, click the “Next” button.

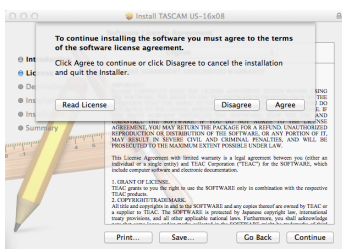

6. Next, click the “Install” button to start installation.

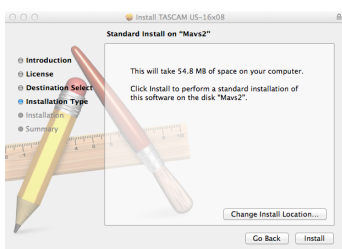

7. The following screen appears when installation has completed. Click the “Close” button.

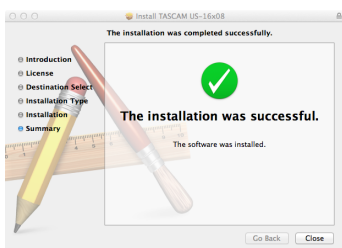

The Settings Panel will launch.

## ■ Working with Gatekeeper

When using Mac OS X, depending on the Gatekeeper security function setting, a warning message might appear during installation.

Resolution depends on the warning message shown. See the following explanations for details.

### When the Gatekeeper setting is “Allow applications downloaded from: the Mac App Store”

The following security warning might be shown: “US-16x08.pkg’ can’t be opened because it was not downloaded from the Mac App Store.”

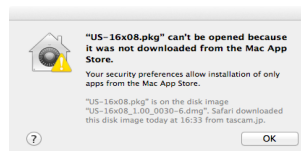

In this case, click the OK button to close the message. Then, control-click (or right-click) the file and click “Open”.

Click the “Open” button if the following security warning message appears: “US-16x08.pkg’ can’t be opened because it was not downloaded from the Mac App Store. Are you sure you want to open it?”



This message might also appear when the Gatekeeper setting is something other than “Allow applications downloaded from: the Mac App Store”

The security warning message “US-16x08.pkg’ can’t be opened because it was not downloaded from the Mac App Store.” could appear again, and you might not be able to open the file.

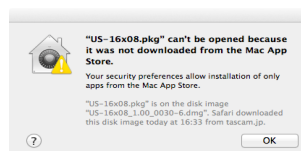

In this case, copy the file from the folder where it is to the desktop or another folder, and then open it. Alternatively, change the Gatekeeper settings to “Allow applications downloaded from: the Mac App Store and identified developers” and try opening it again.



## Changing the Gatekeeper setting

The Gatekeeper setting can be changed using the “Allow applications downloaded from:” item on the “General” page of the “Security & Privacy” pane of the System Preferences.

To change this, you must click the lock icon (🔒) at the bottom left and enter a password to unlock the settings.

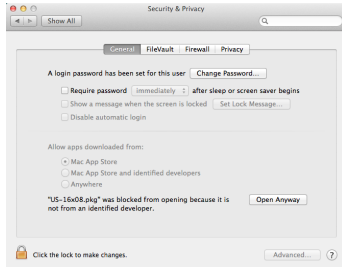

This setting will lock again when you click the “Show All” button at the top left of the window to close the open pane or when you quit the System Preferences by, for example, clicking the round button at the top left corner of the window (⏏) or typing command-Q.

### CAUTION

*Changing the Gatekeeper settings could result in security risks.*

*If you changed the Gatekeeper setting to decrease security (use one of the lower settings), set it back to the original setting after updating the driver and/or firmware.*

## Uninstalling the driver and Settings Panel

### NOTE

*Normally, there is no need to uninstall the driver or Settings Panel. Follow these procedures if a problem occurs or you no longer intend to use the unit with the computer.*

### Windows

Uninstall from the “Programs and Features” Control Panel.

1. From the Start menu, open the Control Panel, and then Programs and Features.

### NOTE

*In Windows 8, to open the Control Panel, right-click the Start screen and click the “All apps” button (or click the ⌵ button that appears at the bottom left of the Start screen in Windows 8.1), then click “Control Panel” on the Apps screen.*

2. If “View by:” is set to “Category”, click “Uninstall a program” under the “Program” item.  
If “View by:” is set to “Large icons” or “Small icons”, click “Programs and Features”.
3. Double-click “TASCAM US-16x08 version X.XX” (“X.XX” is the driver version) in the list.
4. Then, follow the instructions that appear on the screen.

### Mac OS X

Delete the “US-16x08” application from the Application folder to complete uninstallation.

## Automatic launching of the Settings Panel

The Settings Panel will automatically launch when the computer starts up.

This allows the Settings Panel to apply its parameter settings, for example, to the unit. If you use this unit without starting the Settings Panel, the unit will use the default Settings Panel values for parameters. (For information about the default values of the Settings Panel, see “Initializing the Settings Panel settings” on page 19.)

If you do not want the Settings Panel to launch automatically when the computer is started, follow these procedures.

### NOTE

- *The automatic launching setting for the Settings Panel applies only to the user account that was logged in when it was installed.*
- *The Settings Panel cannot be used on an iPad or other iOS device.*

## Windows OS

### Windows 8

1. Right-click the Start screen to show the App Bar. In Windows 8, right-click the Start screen and click the “All apps” button (or the ⌵ button at the bottom left of the screen in Windows 8.1), and click “Task Manager” to open it.
2. Right-click “US-16x08” in the “Start-Up” tab and select “Disable” from the menu.

### NOTE

*If you want to enable automatic launching of the Settings Panel again, right-click “US-16x08” and select “Enable” from the menu.*

### Windows 7

Click the Start button, select All Programs and then Startup. Right-click “US-16x08” and select “Delete” from the menu.

### NOTE

*If you want to enable automatic launching of the Settings Panel again, add a shortcut for “US-16x08” to the Startup menu.*

## Mac OS X

Open the System Preferences app and open the Users & Groups pane. Click Login Items, select “US-16x08\_Setting-Panel” and click the – button.

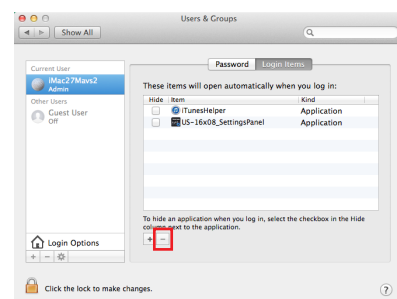

### NOTE

*If you want to enable automatic launching of the Settings Panel again, click the + button and select “US-16x08\_SettingPanel”.*

# 4 – Preparation

## Attaching the rackmount angles

In order to mount this unit in a rack, you must remove the frames and install the included rackmount angles. Follow these procedures to change them.

(You will need a flat-bladed screwdriver.)

1. Use the hex key included with this product to remove the four screws on each side from the positions shown below.

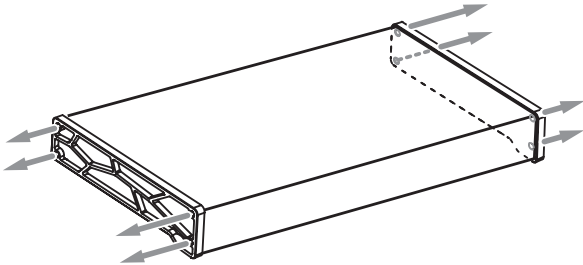

2. Remove the frames from both sides of the unit
3. Attach the included rackmount angles using the rackmount angle attachment screws and the Phillips screwdriver that you prepared.

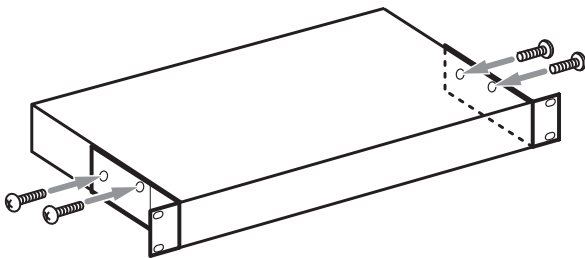

4. Reverse these procedures to reinstall the frame pieces originally attached to the unit.

## Connecting the power

Use the included AC adapter to connect a power supply to the unit as shown below.

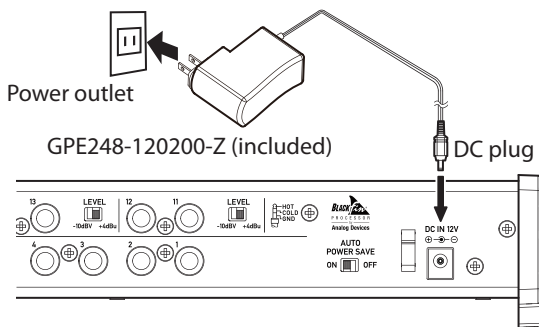

In order to prevent the cord from becoming disconnected during use, always wrap the cord around the cord holder when connecting it.

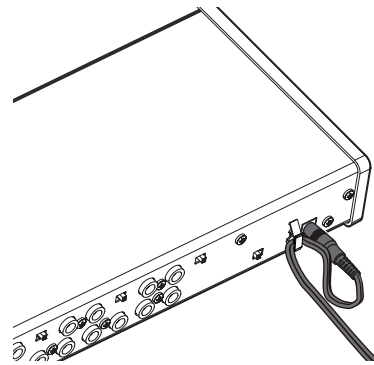

### CAUTION

- Always use the AC adapter (GPE248-120200-Z) that was shipped with the unit. Using a different AC adapter could cause malfunction, overheating, fire or other problems.
- The AC adapter for this unit includes two types of outlet plugs. Attach the type of plug that matches the power outlet that you are using.

### ■ Changing the outlet plug

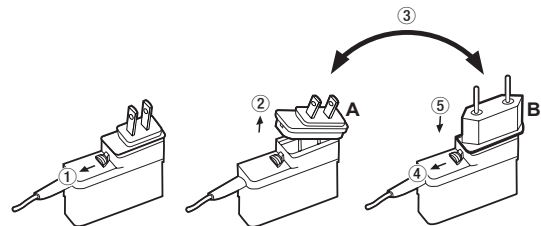

1. Move the latch on the AC adapter in the direction of the arrow.
2. Pull off the outlet plug.
3. Replace it with the other outlet plug (A or B).
4. Move the latch on the AC adapter in the direction of the arrow again.
5. Attach the outlet plug to the AC adapter.

This completes changing the outlet plug.

After changing the outlet plug, confirm that it is not loose or crooked and that everything is normal before plugging it into an outlet.

### CAUTION

*Do not use the adapter if there is anything abnormal about the plug after changing it. Use when the plug is abnormal could cause fire or electric shock. Contact the retailer where you purchased the unit or a TEAC service center (on the back cover) to request repair.*

# 5 – Connections

## Examples of connections with other equipment

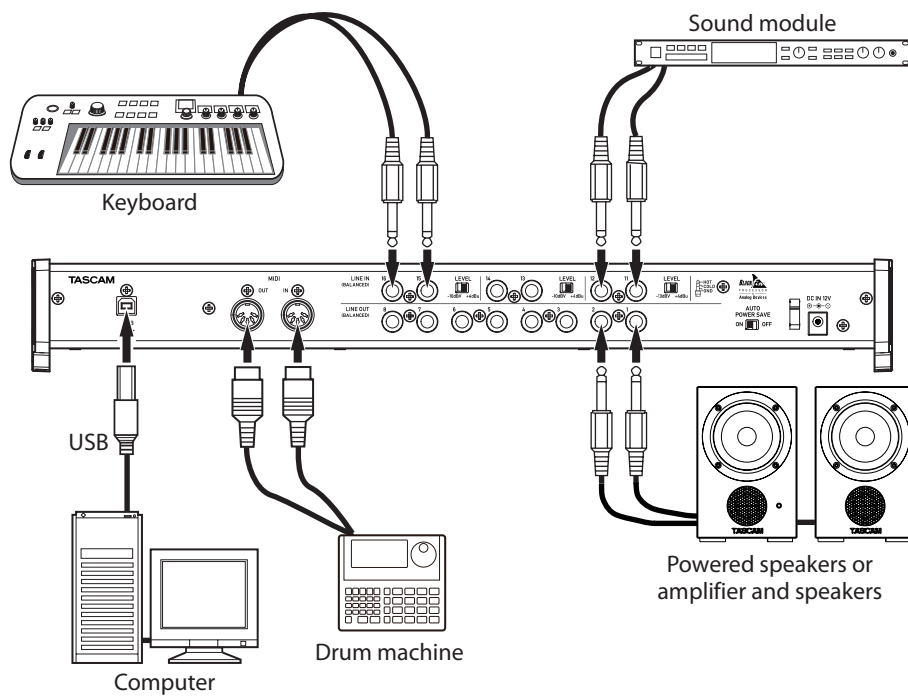
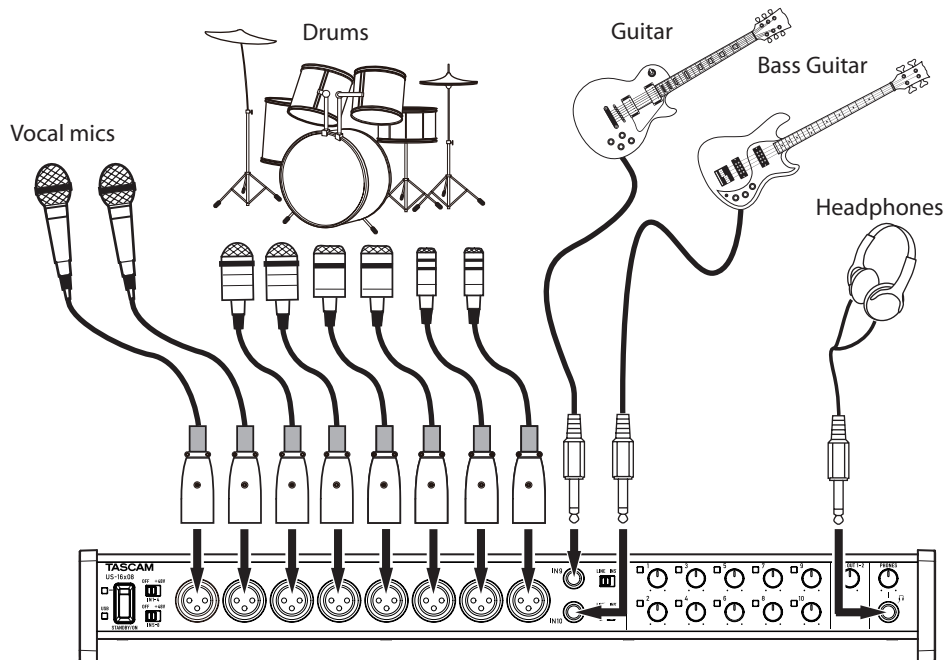

### CAUTION

- Before making connections, turn this unit and all equipment to be connected off (standby).
- The phantom power switches change the settings for groups of 4 channels. Do not set phantom power to +48V when an unbalanced dynamic mic is connected.
- Do not connect or disconnect mics while phantom power is set to +48V. Doing so could cause a loud noise and might damage this unit and connected equipment.
- Set the **LINE OUT** and **PHONES** knobs to their minimum values before switching the phantom power setting between +48V and OFF. Sudden loud noises from monitoring equipment could occur, and this could damage the equipment or harm hearing.
- Supplying phantom power to some ribbon mics will break them. If you are unsure, do not supply phantom power to a ribbon mic.

# 5 – Connections

## Computer connections

Use the included USB cable to connect the unit to a computer USB 2.0/3.0 port. When the USB connection is working, the USB indicator on the front of the unit lights.

### CAUTION

- *If you connect this unit to a computer via a USB hub, for example, audio signal dropouts, clicking noises and other interference could occur due to the influence of other USB devices connected to that hub. For this reason, we strongly recommend connecting this unit to a separate USB port. Connecting USB keyboards and mice, however, to the same bus should not be a problem.*

## Audio connections

Analog audio signals input into this device from mics, guitars, keyboards and other audio equipment can be converted into digital signals and transmitted to the computer via USB. In addition, by connecting speakers (through an amplifier if not powered) or headphones to this unit, you can monitor audio signals that are input to this unit and output from the computer.

### CAUTION

*Before connecting audio equipment, set the unit's 1-10 gain, LINE OUT 1-2 and PHONES knobs to their lowest values. Failure to do so could cause sudden loud noises from monitoring equipment, and this could damage the equipment or harm hearing.*

## Microphones

- Dynamic mics  
Connect mics to the **IN 1-10** jacks on the front of the unit.
- Condenser mics  
When using condenser mics that require phantom power, connect them to the **IN 1-8** jacks, and set the phantom power switches to **+48V**.

### CAUTION

- *Before making connections, turn this unit and all equipment to be connected off (standby).*
- *Do not connect or disconnect mics while phantom power is set to +48V. Doing so could cause a loud noise and might damage this unit and connected equipment.*
- *Set the LINE OUT and PHONES knobs to their minimum values before switching the phantom power setting between +48V and OFF. Sudden loud noises from monitoring equipment could occur, and this could damage the equipment or harm hearing.*
- *Supplying phantom power to some ribbon mics will break them. If you are unsure, do not supply phantom power to a ribbon mic.*

## Guitar

When connecting a guitar or bass guitar directly to this unit, use the **IN 9** or **IN 10** jack on the front of the unit and set the **LINE/INST** switch for that jack to **INST**.

## Electronic and audio devices and other equipment

When connecting an electronic instrument or other audio equipment directly to this unit, use the **IN 9-10** jacks on the front of the unit or the **IN 11-16** jacks on the back and set the **LINE/INST** switches for those jacks to **LINE**.

## Analog record players

The output of an analog record player cannot be connected directly to this unit. To connect an analog record player to this unit, a phono amp and equalizer (or an audio amplifier that has phono input jacks) must be connected between them.

## Monitor speakers

Connect monitor speakers (powered speakers or an amplifier and speaker system) to the **LINE OUT 1-2** jacks on the back of the unit.

Use the **LINE OUT 1-2** knob on the front of the unit to adjust the speaker volume.

## Headphones

Connect headphones to the **PHONES** jack (standard stereo) on the front of the unit.

### CAUTION

*Before connecting headphones, minimize the volume with the PHONES knob. Failure to do so might cause sudden loud noises, which could harm your hearing or result in other trouble.*

## MIDI connections

Connect sound modules, keyboards, synthesizers, drum machines and other MIDI devices to the unit in the following manner.

- *If you want to monitor sound from a MIDI device, connect its outputs to this unit's **IN 9-16** jacks or use an external mixer.*
- *You can also use the **MIDI IN** and **MIDI OUT** connectors on the back of the unit to send and receive MIDI timecode (MTC). By doing this, you can use an application that supports MTC to synchronize a multitrack recorder (MTR) and MIDI devices.*

### CAUTION

*When using Windows Media Player, if the "Sound and Audio Devices Properties" Control Panel "MIDI music playback (default device)" is set to "Microsoft GS Wavetable SW Synth", you will not be able to hear MIDI performances through this unit's **LINE OUT 1-8** or **PHONES** jacks.*

## Connecting with iOS devices

A Lightning to USB Adapter is required.

You will need to prepare an Apple genuine Lightning to USB Adapter (sold separately).

# 6 – Using the Settings Panel

You can use the Settings Panel to change and save settings for the various functions of the unit.

## Opening the Settings Panel

Launch the Settings Panel installed on the computer to show it on the computer display.

Open the Settings Panel in the following ways.

### NOTE

*The Settings Panel cannot be used on an iPad or other iOS device.*

### ■ Windows OS

- Select the Settings Panel from “All Programs” or “All apps”

#### Windows 8

In Windows 8, right-click the Start screen and click the “All apps” button (in Windows 8.1, the  button that appears at the bottom left of the Start screen) to open the Apps screen. On this screen, click the “US-16x08 Settings Panel” item under “TASCAM” to open the Settings Panel.

#### Windows 7

Start button → All Programs → select “US-16x08 Settings Panel” under TASCAM to open the Settings Panel.

- In Windows 8, select “US-16x08 Settings Panel” on the Start screen to open the Settings Panel.

### NOTE

*In Windows 8.1, the application is not automatically added to the Start screen.*

- Open the Settings Panel from the Control Panel.

#### Windows 8

1. In Windows 8, right-click the Start screen and click the “All apps” button (or  button that appears at the bottom left of the Start screen in Windows 8.1), and click “Control Panel” to open it.
2. If the Control Panel is showing categories, set the “View by:” item to “Large icons” or “Small icons”.
3. Select “US-16x08 Settings Panel” to open the Settings Panel.

#### Windows 7

1. Click the Start button and select “Control Panel” to open the Control Panel.
2. If the Control Panel is showing categories, set the “View by:” item to “Large icons” or “Small icons”.
3. Select “US-16x08 Settings Panel” to open the Settings Panel.

### NOTE

*In Windows 8, you can also open the Control Panel by clicking the Control Panel item in the menu that appears if you right-click the bottom left corner of the desktop.*

### ■ Mac OS X

- Using the Finder, open the Applications folder and click “US-16x08\_SettingsPanel” to open the Settings Panel.
- In the Audio Devices window of the Audio MIDI Setup application, right-click (control-click) “US-16x08” (or click the settings icon when the unit name is selected) and click “Configure device...” to open the Settings Panel.

## Settings Panel screen

The Settings Panel has three tabbed pages.

Click a tab at the top of the Settings Panel to open that page.

MIXER: Make built-in mixer and effects settings on this page.

INTERFACE: This page shows the current status of the driver and information about connections. It also allows you to change various settings (Windows only).

OUTPUT SETTING: Make settings for each output on this page.

### CAUTION

- *When you open the Settings Panel, it will have the same state as when it was last closed, but the settings data is not saved automatically. To save the settings of every page (MIXER, INTERFACE and OUTPUT SETTING), use the Scene Memory menu in the menu bar. See “Settings Panel pull-down menus” on page 19 in this manual.*
- *The signals input through each of the 16 channels are transmitted to the computer without being affected by SOLO, MUTE, PAN, and fader settings. For this reason, fader and pan changes made in the Settings Panel will not alter the signals sent to a DAW on the same computer. For details, see “Block diagrams” on page 31.*

# 6 – Using the Settings Panel

## MIXER page

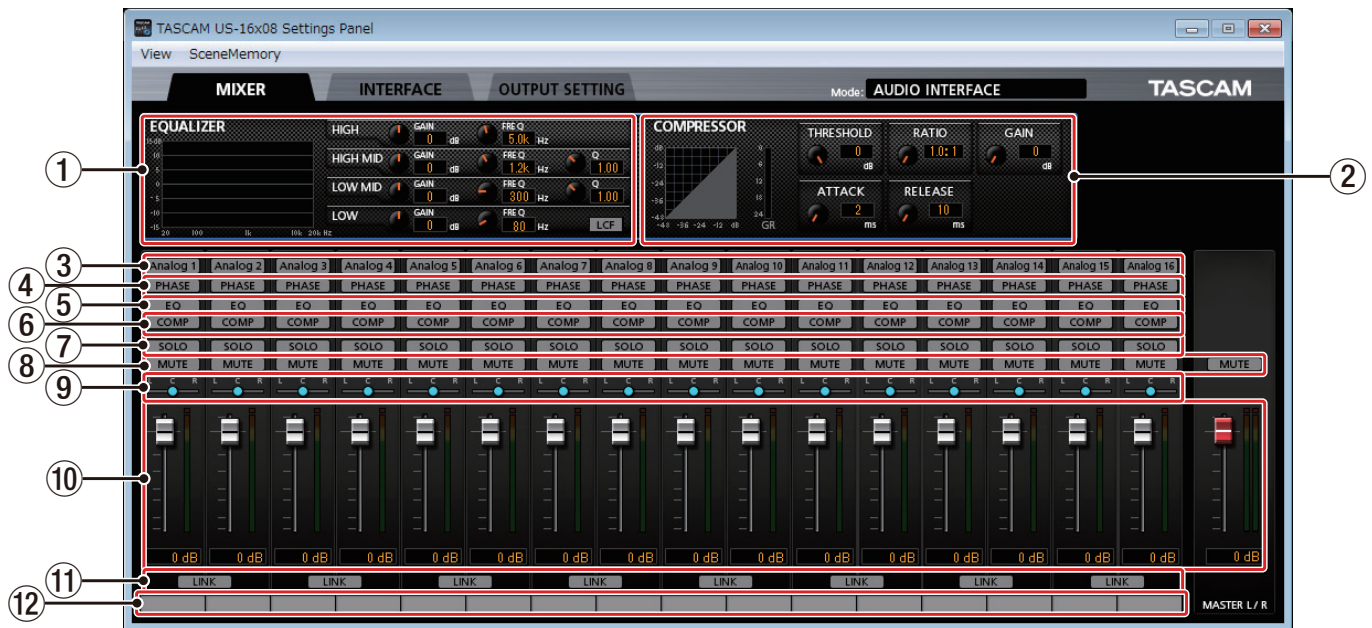

Windows Settings Panel screen

### NOTE

On a Mac, "View" and "SceneMemory" appear in the menu bar at the top of the screen. For details, see "Settings Panel pull-down menus" on page 19.

#### ① EQUALIZER (4-band parametric EQ)

Use the equalizer to increase or decrease the levels of specific frequency ranges. This can be used, for example, to enhance the sound of individual instruments, to adjust the balance of a wide frequency range and to cut specific unwanted frequencies.

The frequency response with the current settings is shown as a graph even when the equalizer is off.

The equalizer has a high-shelf HIGH band, a low-shelf LOW band and peaking (bell-shaped) HIGH MID and LOW MID bands.

##### HIGH GAIN knob

Sets the amount the level is increased or decreased for the HIGH band.

Range:  $\pm 12$  dB (default: 0 dB)

##### HIGH FREQ knob

Sets the cutoff frequency of the HIGH band.

Range: 1.7 kHz – 18.0 kHz (default: 5.0 kHz)

##### HIGH MID GAIN knob

Sets the amount the level is increased or decreased for the HIGH MID band.

Range:  $\pm 12$  dB (default: 0 dB)

##### HIGH MID FREQ knob

Sets the center frequency of the HIGH MID band.

Range: 32 Hz – 18.0 kHz (default: 1.2 kHz)

##### HIGH MID Q knob

Sets the acuteness of the peak of the HIGH MID band.

The higher the value the more acute it becomes, making it affect a narrower frequency band. The lower the value,

the less acute it becomes, making it affect a broader frequency band.

Range: 0.25 – 16.00 (default: 1.00)

##### LOW MID GAIN knob

Sets the amount the level is increased or decreased for the LOW MID band.

Range:  $\pm 12$  dB (default: 0 dB)

##### LOW MID FREQ knob

Sets the center frequency of the LOW MID band.

Range: 32 Hz – 18.0 kHz (default: 300 Hz)

##### LOW MID Q knob

Sets the acuteness of the peak of the LOW MID band.

The higher the value the more acute it becomes, making it affect a narrower frequency band. The lower the value, the less acute it becomes, making it affect a broader frequency band.

Range: 0.25 – 16.00 (default: 1.00)

##### LOW GAIN knob

Sets the amount the level is increased or decreased for the LOW band.

Range:  $\pm 12$  dB (default: 0 dB)

##### LOW FREQ knob

Sets the cutoff frequency of the LOW band.

Range: 32 Hz – 1.6 kHz (default: 80 Hz)

##### LCF button

Turn the LCF button on to enable the low-cut filter, which cuts noise and other sounds at low frequencies.

Off (default): LCF button unlit

On: LCF button lit

To set the equalizer for a channel, select its Analog X button (③).

The equalizer settings will be shown for the channel selected by its Analog X button (③).

## 6 – Using the Settings Panel

### ② COMPRESSOR

When the input volume exceeds the THRESHOLD level, the input volume is compressed, reducing output volume variation.

For example, by reducing the high level parts of sounds as they occur, a more even volume level throughout can be achieved. This allows lower-level sounds to be raised, resulting in a fuller sound.

Three meters show the level of the signal input to the compressor (INPUT), the level of the signal output from the compressor (OUTPUT) and the gain reduction caused by the compressor (GR).

#### THRESHOLD knob

Sets the threshold level that will cause the effect to start.

Range: –32 dB – 0 dB (default: 0 dB)

#### RATIO knob

Sets the compression ratio for the input volume.

Turning it right raises the compression ratio, increasing the amount of compression.

Range: 1.0:1 – inf:1 (default: 1.0:1)

#### GAIN knob

Sets the gain of the output signal.

When the volume is compressed, the output level becomes lower than the input level. Use the GAIN knob to increase the output level so that it is close to the input level.

Range: 0 dB – 20 dB (default: 0 dB)

#### ATTACK knob

Sets the amount of time until the compression reaches the compression RATIO setting after the input volume exceeds the threshold.

Range: 2 ms – 200 ms (default: 2 ms)

#### RELEASE knob

Sets the amount of time until the compression stops and the sound returns to its uncompressed level after the input sound goes below the threshold.

Range: 10 ms – 1000 ms (default: 10 ms)

To set the compressor for a channel, select its Analog X button (③).

The compressor settings will be shown for the channel selected by its Analog X button (③).

#### NOTE

- *If the input is a stereo signal (stereo-linked channel or master), compression will start and be applied to both channels when either the left or right input channel exceeds the threshold level.*
- *When the compressor is off, the compressor curve will appear but the meters will not be active.*

### ③ Analog X buttons

When an Analog X button ("X" is the channel number) is on (lit), the equalizer (①) and compressor (②) settings for that channel will be shown and can be adjusted as desired.

Off (default): Analog X button unlit

On: Analog X button lit

You can only select one channel at a time. Multiple Analog X buttons cannot be on at the same time.

When a channel is selected, click a different channel's button to select that channel. The previously selected channel button will become unlit, and the newly selected channel button will light.

### ④ PHASE buttons

Turn a PHASE button on to reverse the phase of that channel.

### ⑤ EQ buttons

Turn an EQ button on to enable the equalizer on that channel.

### ⑥ COMP buttons

Turn a COMP button on to enable the compressor on that channel.

### ⑦ SOLO buttons

Turn a SOLO button on to solo that channel.

With this unit, when the SOLO button of a channel is enabled, all other channels are automatically muted (solo-in-place monitoring).

The MUTE buttons for channels that are muted will light. (Default: off)

Multiple channels can be soloed at the same time.

#### NOTE

- *When all the SOLO buttons are off, clicking the SOLO button of one channel will put the unit into solo mode and automatically mute the other channels, lighting their MUTE buttons.*
- *When all SOLO buttons are disabled, channels that had been automatically muted will become unmuted. Channels that had been individually muted before the unit entered solo mode will remain muted.*
- *The MASTER L/R channel MUTE button will not turn on automatically when the unit enters solo mode.*

### ⑧ MUTE buttons

Turn a MUTE button on to mute that channel.

(Default: off)

#### NOTE

*In addition to turning the MUTE button on and off, channels will be automatically muted and unmuted when SOLO buttons are used*

### ⑨ Pan sliders

Use these to adjust the stereo positions of the signals input to each channel when they are sent to the stereo bus.

Use the mouse to click and drag a pan slider left or right to adjust the position.

While dragging the mouse, the value being adjusted is shown in its fader level display area (above ⑩).

The value is L20 when set all the way to the left, C when set in the center and R20 when set all the way to the right.

Setting range: L20 – L1, C (default), R1 – R20 (41 steps total with C at the center and 20 steps to both left and right.)

A pan slider appears blue when centered (C) and yellow at all other positions.

#### NOTE

- *If a pan slider is centered (C), the signal is reduced by 3 dB and sent to both the left and right channels of the stereo bus.*
- *Double-click a pan slider to return it to the center (C) position.*
- *When a pan slider is set to the left end (L20), the signal for that channel is sent only to the left channel of the stereo bus. It is not sent to the right channel of the stereo bus.*

## 6 – Using the Settings Panel

- *When a pan slider is set to the right end (R20), the signal for that channel is sent only to the right channel of the stereo bus. It is not sent to the left channel of the stereo bus.*

### ⑩ Faders and level meters

Use the faders for each channel to adjust the levels of the channel signal sent to the stereo bus. Use the master fader to adjust the master output level.

The channel level meters show their signal levels. The master level meters show the levels of the mixed signal.

The fader level display area (bottom of ⑩) shows the fader gain value.

The channel and master level meters show green bars for values less than -12 dB, yellow bars for -12 dB to -6 dB, and red bars for values greater than -6 dB.

Each level meter has an overload indicator at its top.

Range: +6 dB to  $-\infty$  (default: 0 dB)

### NOTE

- *Using the mouse, drag a fader to adjust its level. Move the fader up to increase the level or down to decrease it.*
- *Double-click a fader to return it to its default (0 dB) position.*
- *The channel meters show the levels before being adjusted by the faders. Level meters are not affected by fader adjustments or even their channels being muted.*

### ⑪ LINK buttons

Turn a LINK button on to combine two adjacent channels (odd and even) into a single stereo channel.

When stereo link mode is enabled, the buttons, knobs and faders of the two channels are combined. The channel level meters are also shown as a stereo pair.

When linked, the LINK button lights. (Default: off)

When a LINK button is enabled (combining two adjacent channels as a stereo channel), the settings become as follows.

Analog X: If either the odd or even channel is turned on, this turns on. If both the odd and even channels are off, this turns off. In addition, the button name changes to "Analog X-Y" ("X" is the odd channel number and "Y" is the even channel number).

PHASE: The settings are not combined. The settings of the channels do not change.

EQ: The setting of the odd-numbered channel is applied.

COMP: The setting of the odd-numbered channel is applied.

SOLO: The setting of the odd-numbered channel is applied.

MUTE: The setting of the odd-numbered channel is applied.

Pan sliders: The settings are not combined. The setting of each channel can be set independently.

Level faders: The setting of the odd-numbered channel is applied.

- Turn a LINK button off to split a single stereo channel into two mono channels. The settings for each of the mono channels become as follows.

Analog X-Y: If on when the LINK button is turned off, the odd channel stays on, but the even channel turns off. If off when the LINK button is turned off, both channels stay off.

PHASE: The settings are not changed. The setting of each channel stays as it was.

EQ: The settings of both channels stay the same as the combined stereo channel.

COMP: The settings of both channels stay the same as the combined stereo channel.

SOLO: If on when the LINK button is turned off, this stays on for both channels. If off when the LINK button is turned off, both channels stay off.

MUTE: If on when the LINK button is turned off, this stays on for both channels. If off when the LINK button is turned off, both channels stay off.

Pan sliders: These stay the same when the LINK button is turned off.

Level faders: The settings of both channels stay the same as the combined stereo channel.

### ⑫ Track notes

You can input up to six English letters and numbers.

### How to input characters

Click a note area to ready it for input. The cursor will blink.

Then, use the computer keyboard to input characters.

After you complete inputting characters, press the Enter key on the computer keyboard.

### NOTE

*You must press the Enter key on the computer keyboard after you complete inputting characters to confirm the input. If you move to a different page from the MIXER page without pressing the Enter key, the input characters will be shown, but not saved.*



## INTERFACE page

### Windows

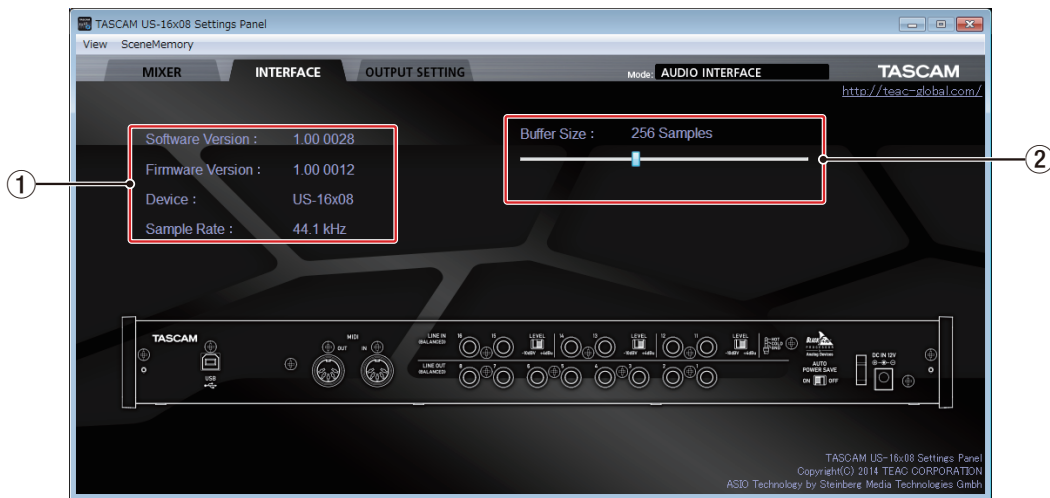

Windows Settings Panel screen

### Mac OS X

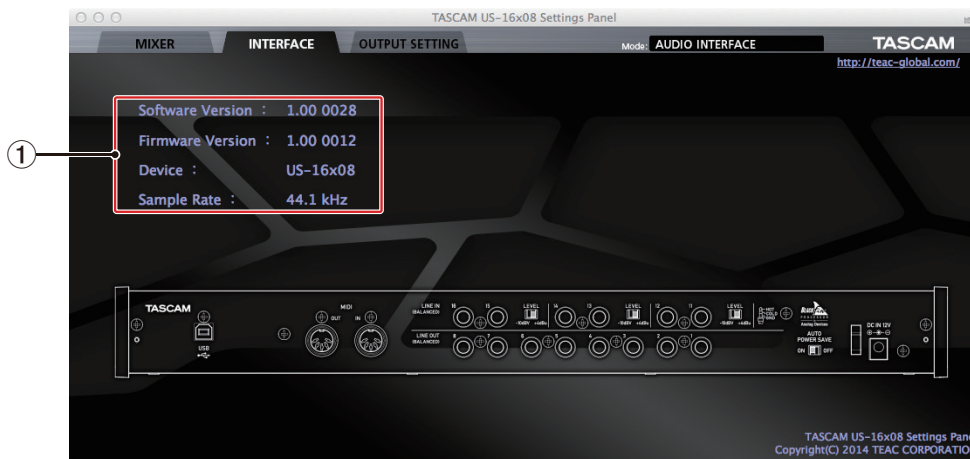

Mac Settings Panel screen

The “INTERFACE” page has a unit status area and, on Windows only, a “Buffer Size” area.

Beneath these areas is an image of the rear panel of the unit that you can use to check the layout of the jacks, for example. No settings can be changed on this page.

#### ① Status display area

This shows the current status of the unit.

Item displayed	Meaning
<b>Software Version</b>	This is the software version used by unit.
<b>Firmware Version</b>	This is the firmware version used by the unit. <sup>1</sup>
<b>Device</b>	This is the name of the unit. <sup>1</sup>
<b>Sample Rate</b>	This is the current sampling frequency. <sup>2</sup>

<sup>1</sup> “No Device” is shown when no device is connected.

<sup>2</sup> “No ASIO Driver” is shown when an ASIO driver has not been installed.

#### ② Buffer Size (Windows only)

The driver for the unit stores the audio input and output signals transferred to and from the computer temporarily in a buffer. This buffer size can be adjusted.

Smaller buffer sizes result in less audio signal delay (latency), but require high-speed processing by the computer.

If the processing cannot keep up, for example, due to other system operations, clicking and popping noises might occur and the audio signal might even drop out.

Increasing the buffer size will stabilize operation and suppress negative effects on audio signals, but the delay in audio signals sent to the computer will increase.

You can use the slider on the panel to adjust the buffer size, according to the use conditions.

Use the slider to select fixed values that increase from left to right (64, 128, 256, 512, 1024 and 2048 samples).

# 6 – Using the Settings Panel

## OUTPUT SETTING page

On the OUTPUT SETTING page, you can visually check the routing of signals output from the **LINE OUT 1-8** jacks and select them.

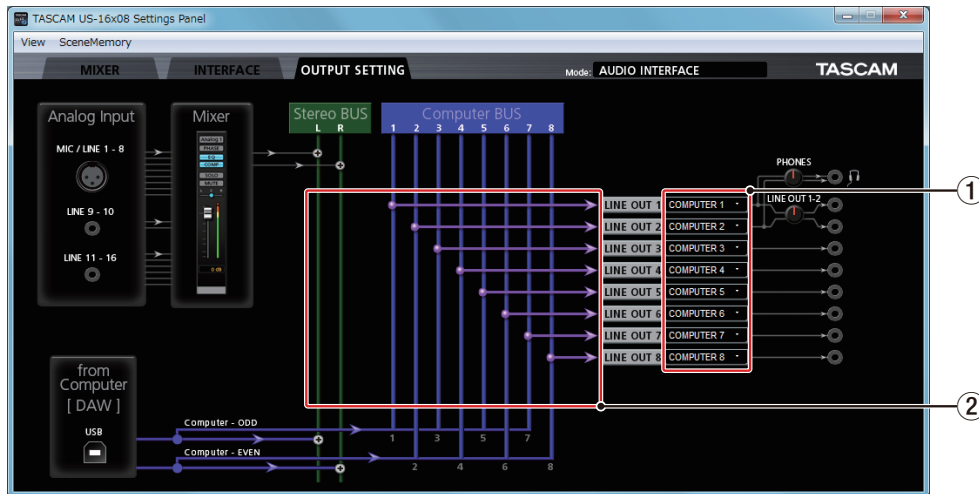

Windows Settings Panel screen

### ① Output signal selection

Click a box to the right of a LINE OUT X (“X” is 1–8) label to open a pull-down menu with BUS line selection options. Select the signal that you want to output from this menu.

Options: COMPUTER 1 – COMPUTER 8, MASTER L/MASTER R

### ② Output signal routing status

This shows the connection of the signals with the output jacks as selected in area ①.

#### • Stereo BUS outputs

The signals input through each input jack and by USB output from the computer are mixed and output in stereo. For details, see “Block diagrams” on page 31 in this manual.

#### • Computer BUS outputs

Select output signals from the Computer BUS (1–8), which come from DAW software running on the computer, to output them directly from the desired jacks.

### NOTE

*The output signals selected for LINE OUT 1 and LINE OUT 2 will also be output from the PHONES (L/R) jack.*

# 6 – Using the Settings Panel

## Settings Panel pull-down menus

The Settings Panel has View and SceneMemory pull-down menus that can be used to initialize and save settings, for example.

### View menu

This menu includes functions to restore the settings of the Settings Panel to their defaults (Initialize), minimize the application to the taskbar (Minimize) and close the Settings Panel (Close).

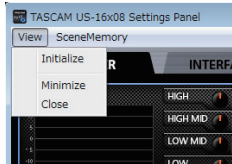

Windows version

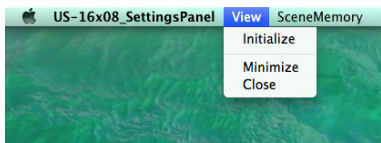

Mac version

#### Initialize

Select this to reset all the Settings Panel settings.  
For details, see “Initializing the Settings Panel settings” on page 19 in this manual.

#### Minimize

Minimize the Settings Panel screen to the taskbar (or Dock on a Mac).

#### Close

Close the Settings Panel screen and quit the application.

### ■ Initializing the Settings Panel settings

Select this to reset all the Settings Panel settings.

#### NOTE

*The Windows Buffer Size setting is not restored to the factory default.*

#### CAUTION

*After initializing, you cannot restore the previous settings.*

1. In the menu bar, Click “Initialize” in the View menu (Windows/Mac).

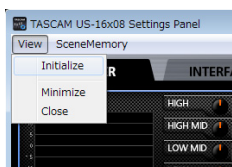

Windows version

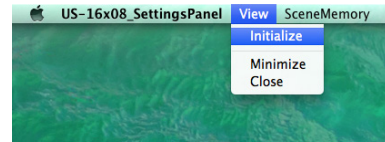

Mac version

2. A confirmation message will appear. Click the “OK” button in the message window to reset the Settings Panel settings to their default values.

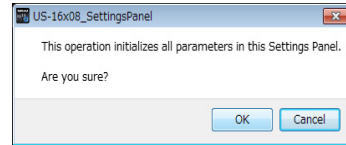

Windows version

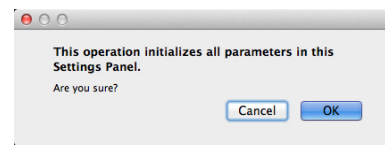

Mac version

#### NOTE

*Click the “Cancel” button to return to the Settings Panel without initializing.*

Using the Initialize function will result in the following settings.

Page	Item	Default value	
MIXER	EQUALIZER	HIGH (GAIN)	0 dB
		HIGH (FREQ)	5.0 kHz
		HIGH MID (GAIN)	0 dB
		HIGH MID (FREQ)	1.2 kHz
		HIGH MID (Q)	1.00
		LOW MID (GAIN)	0 dB
		LOW MID (FREQ)	300 Hz
		LOW MID (Q)	1.00
		LOW (GAIN)	0 dB
		LOW (FREQ)	80 Hz
	LCF	OFF	
	COMPRESSOR	THRESHOLD	0 dB
		RATIO	1.0: 1
GAIN		0 dB	
ATTACK		2 ms	
RELEASE		10 ms	
PAN		C (center)	
	Channel faders	0 dB	
	Master fader	0 dB	
OUTPUT SETTING	LINE OUT 1	COMPUTER 1	
	LINE OUT 2	COMPUTER 2	
	LINE OUT 3	COMPUTER 3	
	LINE OUT 4	COMPUTER 4	
	LINE OUT 5	COMPUTER 5	
	LINE OUT 6	COMPUTER 6	
	LINE OUT 7	COMPUTER 7	
	LINE OUT 8	COMPUTER 8	

#### NOTE

- *If you turn the unit on without launching the Settings Panel, the LINE OUT 1-8 output settings will be set to COMPUTER 1-8.*
- *There is no Settings Panel for iOS devices, so the unit will operate with its default settings.*

# 6 – Using the Settings Panel

## SceneMemory menu

Up to 10 Settings Panel states can be saved as scene memories.

The SceneMemory menu starts with 10 SceneMemoryX ("X" being 1–10) memories. Select one of these scene memories to open a submenu that allows you to Save, Load or Rename it.

You can also initialize all 10 scene memories at the same time.

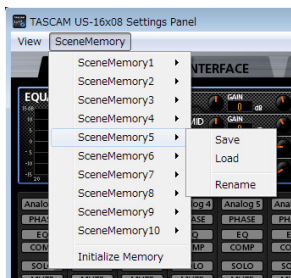

Windows version

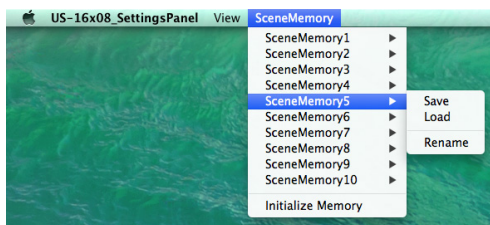

Mac version

### Save

Use this to save all Settings Panel settings except the on/off status of the Analog X buttons. For details, see "Saving Settings Panel settings" on page 20 in this manual.

### Load

Use this to immediately apply settings that have been saved to the selected scene memory. For details, see "Loading Settings Panel settings" on page 20 in this manual.

### Rename

Use this to change the name of the scene memory that is saved. For details, see "Input and output channels in mic preamp mode" on page 22 in this manual.

## ■ Saving Settings Panel settings

The current Settings Panel settings can be saved in a scene memory.

Ten scene memories can be saved.

### CAUTION

*Only one set of Settings Panel settings can be saved in each scene memory. For this reason, saving settings to a scene memory will erase the previously saved settings.*

1. In the menu bar, click the name of a scene memory in the SceneMemory menu (Windows/Mac) to open the submenu.

2. Click "Save" in the submenu to save the current Settings Panel settings to the selected scene memory.

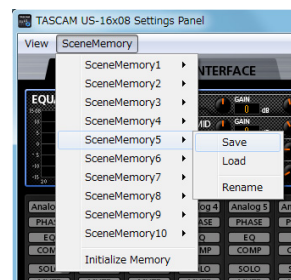

Windows version

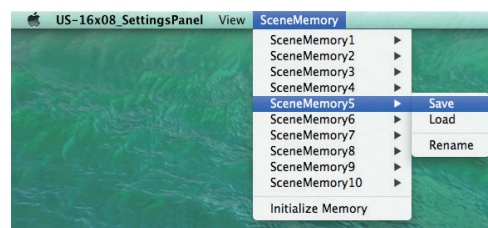

Mac version

## ■ Loading Settings Panel settings

You can immediately change the current Settings Panel settings to settings saved in a scene memory by loading it.

### CAUTION

*If you load a scene memory, the previous settings cannot be restored. If you want to keep the current settings, save them to a different scene memory.*

1. Click the name of the scene memory that you want to load in the SceneMemory menu to open the submenu.
2. Click "Load" in the submenu to immediately change the Settings Panel settings to those saved in the scene memory.

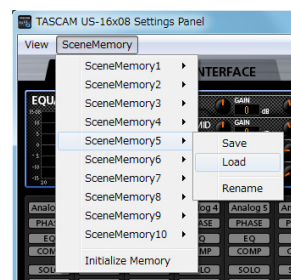

Windows version

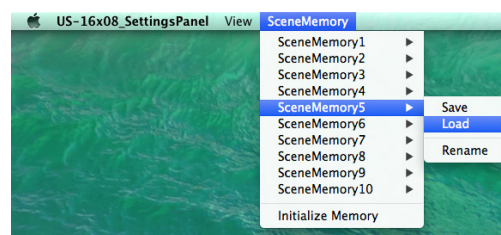

Mac version

# 6 – Using the Settings Panel

## CAUTION

Scene memories that you have never saved do not contain any Settings Panel settings. If you try to load such a scene memory, the following confirmation message will appear.

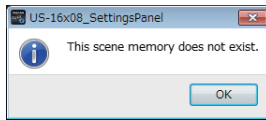

Windows version

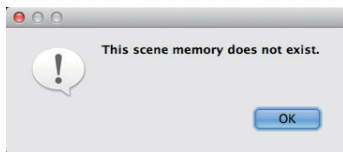

Mac version

## Changing a scene memory name

You can change the names of scene memories.

1. From the menu bar, click the name of a scene memory in the SceneMemory menu (Windows/Mac) to open the submenu.
2. Click “Rename” in the submenu.

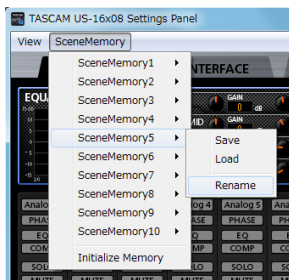

Windows version

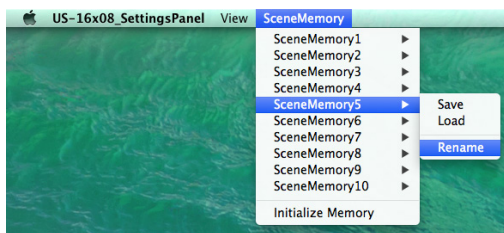

Mac version

3. The following name input window will open.

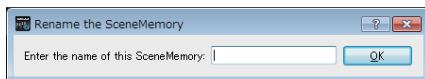

Windows version

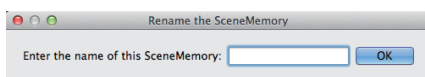

Mac version

4. After you complete inputting the new name, click the “OK” button in the window.

## Initializing all ten scene memories

You can initialize all scene memories at the same time.

## CAUTION

After resetting, you cannot restore the previous settings.

1. In the menu bar, click “Initialize Memory” in the SceneMemory menu (Windows/Mac).

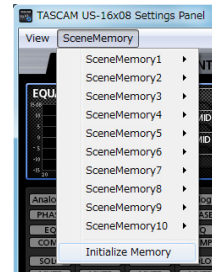

Windows version

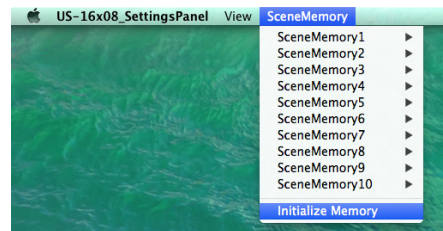

Mac version

2. A confirmation message will appear. Click the “OK” button in the message window to reset the scene memory Settings Panel settings to their default values.

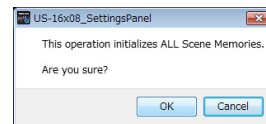

Windows version

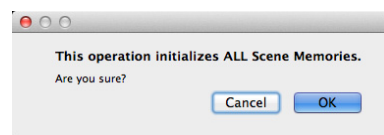

Mac version

## NOTE

Click the “Cancel” button to return to the Settings Panel without initializing.

# 7 – Mic Preamp Mode

---

## Using the unit as a standalone mic preamp

---

This unit will operate in mic preamp mode when it is not connected to a computer by USB.

You can use this unit's mic preamps even when it is not connected to a computer.

### ■ Input and output channels in mic preamp mode

In mic preamp mode, the routing of input to output channels is fixed as follows.

Input	Output
IN1	LINE OUT1
IN2	LINE OUT2
IN3	LINE OUT3
IN4	LINE OUT4
IN5	LINE OUT5
IN6	LINE OUT6
IN7	LINE OUT7
IN8	LINE OUT8

You can adjust the input level of each channel using its gain knob.

### NOTE

*When shipped from the factory, the LINE OUT 1-2 knob is set to its minimum value, so no sound will be output from the LINE OUT 1-2 jacks. When using the unit in mic preamp mode, set the LINE OUT 1-2 knob to its maximum value.*

# 8 – Application Guide

In this chapter, we explain how to set some audio applications for use with this unit.

## ■ DAW software

The ways that settings are made differ among DAWs.

When using a DAW software, consult its operation manual.

## Windows Media Player

### Windows 8

1. Quit all applications and right-click the Start screen to show the App Bar. Then, click the All apps button to open the Apps screen.

#### NOTE

*In Windows 8.1, click the  button that appears at the bottom left of the Start screen.*

2. Click Control Panel.
3. Click "Hardware and Sound", and then open the "Sound" window.
4. On the Playback page, right-click "Speakers TASCAM US-16x08", and click "Set as Default Device" in the pop-up menu that appears.

When you do this, the green check mark (✓) appears next to Speakers TASCAM US-16x08.

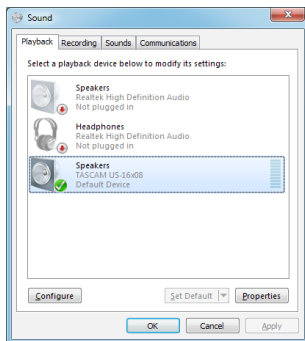

#### NOTE

*To use this unit as the recording device, open the Recording page and use Set as Default Device for Line In TASCAM US-16x08.*

5. After completing the setting, click the "OK" button.
6. Launch Windows Media Player, select an audio file and start playback.

#### NOTE

- *If you change the setting while Windows Media Player is running, the software will not recognize that the device has been changed. In this case, restart Windows Media Player.*
- *If you still cannot hear sound after making the settings and completing the procedures above, restart the computer.*
- *If you make this setting, sound will be output through this unit, but no sound will be output from the computer's speakers or headphone jack.*

### Windows 7

1. Quit all applications and open the Control Panel from the Start button menu.
2. Open "Sound".

#### NOTE

*If you do not see this item, click Hardware and Sound.*



3. On the Playback page, right-click "Speakers TASCAM US-16x08", and click "Set as Default Device" in the pop-up menu that appears.

When you do this, the green check mark (✓) appears next to Speakers TASCAM US-16x08.

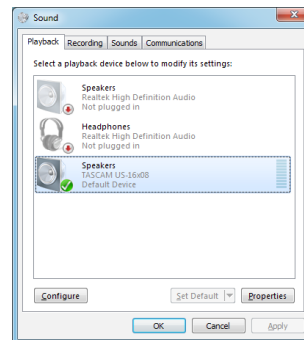

#### NOTE

*To use this unit as the recording device, open the Recording page and use Set as Default Device for Line In TASCAM US-16x08.*

4. After completing the setting, click the OK button.
5. Start Windows Media Player, select an audio file and begin playback.

#### NOTE

- *If you change the setting while Windows Media Player is running, the software will not recognize that the device has been changed. In this case, restart Windows Media Player.*
- *If you still cannot hear sound after making the settings and completing the procedures above, restart the computer.*
- *If you make this setting, sound will be output through this unit, but no sound will be output by the computer's speakers or headphone jack.*

# 8 – Application Guide

## Mac OS X and iTunes

1. Open the Utilities folder within the “Applications folder”, and double-click “Audio MIDI Setup”. Then open the “Audio Devices” window.
2. Click “US-16x08” to select it and right-click or control-click it. Then, click “Use this device for sound output” in the pop-up menu.

The speaker mark appears next to US-16x08.

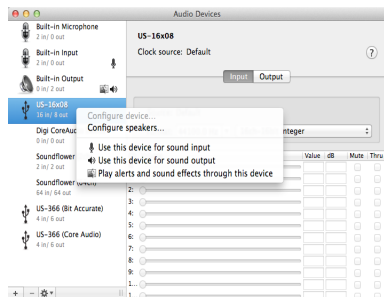

### NOTE

*To use this device as the recording device, select “Use this device for sound input” for the “US-16x08”.*

3. Launch iTunes, select an audio file and start playback.

## iOS

No settings are necessary to use this unit with an iOS device. You can use it right away after connecting to the device by USB.

### NOTE

*Connecting headphones, for example, to the headphone jack of the iOS device will interrupt USB communication with this unit.*



# 9 – MIDI Implementation Chart

## ■ MIDI Implementation Chart

Function		Transmit	Recognize	Remarks
Basic channels	When power on	×	×	Thru
	Settable	×	×	
Mode	When power on	×	×	Thru
	Messages	×	×	
	Altered	.....		
Note number	Range	×	×	Thru
Velocity	Note on	×	×	Thru
	Note off	×	×	
Aftertouch	Polyphonic	×	×	Thru
	Channel	×	×	
Pitch bend		×	×	Thru
Control change		×	×	Thru
Program change		×	×	Thru
	Settable range #	.....		
System exclusive		×	×	Thru
System common	Position	×	×	Thru
	Song select	×	×	
	Tune	×	×	
System real-time	Clock	×	×	Thru
	Command	×	×	
Other	Local on/off	×	×	Thru
	All notes off	×	×	
	Active sense	×	×	
	Reset	×	×	
Notes				

Mode 1: OMNI ON, POLY  
Mode 3: OMNI OFF, POLY

Mode 2: OMNI ON, MONO    ○ : YES  
Mode 4: OMNI OFF, MONO    × : NO

# 10 – Troubleshooting

## Troubleshooting

Please read this chapter if you are unable to use the unit properly even after setting it up following the procedures in this manual.

If you are still unable to resolve a problem, please contact a TASCAM customer center (see back of document) with the following information about the operating environment and details about the trouble.

### Operating environment

- Computer manufacturer:
- Model:
- CPU:
- Memory (RAM):
- Operating system:
- Applications used:
- Antivirus software:
- Wireless LAN use:

See the end of this document for contact information.

### ■ Installation fails.

#### ■ Installation completes, but the computer does not recognize the unit.

If some trouble is causing installation to fail, or if the computer does not recognize the unit even though installation completes, check the following.

##### 1. Change the USB port

Since the unit might not properly function with some USB ports, try connecting to a different USB port that is built into the computer, and reinstall the driver.

### NOTE

- *Try again after disconnecting other USB devices. (Keyboards and mice can be left connected.)*
  - *Do not use a USB hub. Always connect the unit directly to a USB port on the computer (built-in).*
2. Stop software that is running in the background
- Since antivirus software and other software running in the background can interfere with installation, stop them before beginning installation. See "Installing the driver and Settings Panel" on page 6 in this manual for how to install and uninstall the driver and Settings Panel.

### ■ There is no sound even when audio is playing back.

The audio output must be set on the computer.

Please confirm the following while the unit is connected to the computer. Moreover, if you make the following settings, sound will be output through this unit, but no sound will be output by the computer's speakers or headphone jack.

### Windows 8/Windows 7

- See the "Windows 8" or "Windows 7" instructions in the "Windows Media Player" section of the "Application guide" chapter of the Reference Manual, and make settings as necessary for the OS.
- Conduct procedures 1-4 for Windows 8 or procedures 1-3 for Windows 7 to set the default device for playback.

### Mac OS X

Quit all applications and open "System Preferences..." from the Apple menu.

Open "Sound", and select "US-16x08" on the Output tab.

After completing the setting, restart the computer and check the sound of playback.

Depending on the application that you are using, you might need to make additional device settings.

In particular, DAW applications operate using audio engines with settings that are different from the OS settings, so first confirm the DAW settings after installing the driver and Settings Panel for this unit.

Please see the manuals for the applications that you are using for detailed setting procedures.

### ■ Sound breaks up or there is noise.

The processing load on the computer causes sound to break up and noise to occur.

Here are some methods to reduce the load on the computer.

1. A wireless LAN and software running in the background, including antivirus software, regularly put processing loads on the computer, which can cause sound to break up and other noise. Stop wireless LAN transmission, antivirus software and other software running in the background when using this unit.
2. Set the buffer size (latency) in the audio application that you are using or in this unit's Settings Panel to a larger value. (Windows only)

### NOTE

*Consult the maker of the audio application that you are using for methods to reduce its load on your computer.*

3. Change the settings of your computer so that they are optimal for audio processing.

### Windows 8

- 1 In Windows 8, right-click the ordinary Start screen (Metro user interface screen) and then click "All apps".
- 2 Right-click "Computer" and select "Properties".
- 3 Click "Advanced system settings".
- 4 Click "Settings" in the "Performance" section of the "Advanced" tab of the "System Properties" window.
- 5 In the "Visual Effects" tab of the "Performance Options" window, select "Adjust for best performance".

### Windows 7

- a) Turn Aero off.
  - 1 Right-click the desktop and select "Personalize".
  - 2 Select a "Basic" or "High Contrast" theme.
- b) Performance settings
  - 1 Right-click "Computer" and select "Properties".
  - 2 Click "Advanced system settings".
  - 3 Click "Settings" in the "Performance" section of the "Advanced" tab of the "System Properties" window.
  - 4 In the "Visual Effects" tab of the "Performance Options" window, select "Adjust for best performance".

### Mac OS X

- 1 Open "System Preferences..." from the Apple menu, and select "Energy Saver".
- 2 Set "Computer sleep" to "Never".
- 3 Set "Display sleep" to "Never".

### NOTE

*Depending on the Mac OS X version and Mac computer model, this setting might not be available.*

##### 4. Change the USB port

Since the unit might not properly function with some USB ports, try connecting to a different USB port that is built into the computer.

### NOTE

- *Try again after disconnecting other USB devices. (Keyboards and mice can be left connected.)*
- *Do not use a USB hub. Always connect the unit directly to a USB port on the computer (built-in).*

# 11 – Specifications

---

## Specifications

---

### Ratings

#### ■ Sampling frequencies

44.1/48/88.2/96 kHz

#### ■ Quantization bit depth

16-bit or 24-bit

---

### Analog inputs

#### ■ IN 1-8 mic inputs (balanced)

Connector: XLR-3-31 equivalent

(1: GND, 2: HOT, 3: COLD)

Input impedance: 2.4 kΩ

Nominal input level: -68 dBu (0.0003 Vrms)

(gain knob at maximum)

Nominal input level: -12 dBu (0.195 Vrms)

(gain knob at minimum)

Maximum input level: +8 dBu (1.947 Vrms)

Gain range: 56 dB

#### ■ IN 9-10 instrument inputs (unbalanced)

(LINE/INST switch set to INST)

Connectors: 6.3mm (1/4") standard TS jacks

(Tip: HOT, Sleeve: GND)

Input impedance: 1 MΩ or more

Nominal input level: -57 dBV (0.0014 Vrms)

(gain knob at maximum)

Nominal input level: -12 dBV (0.251 Vrms)

(gain knob at minimum)

Maximum input level: +8 dBV (2.512 Vrms)

Gain range: 45 dB

#### ■ IN 9-10 line inputs (balanced)

(LINE/INST switch set to LINE)

Connectors: 6.3mm (1/4") standard TRS jacks

(Tip: HOT, Ring: COLD, Sleeve: GND)

Input impedance: 10 kΩ

Nominal input level: -41 dBu (0.0069 Vrms)

(gain knob at maximum)

Nominal input level: +4 dBu (1.228 Vrms)

(gain knob at minimum)

Maximum input level: +24 dBu (12.282 Vrms)

Gain range: 45 dB

#### ■ LINE IN 11-16 line inputs (unbalanced)

(LEVEL switch set to "-10dBV")

Connectors: 6.3mm (1/4") standard TS jacks

(Tip: HOT, Sleeve: GND)

Input impedance: 10 kΩ

Nominal input level: -10 dBV (0.3162 Vrms)

Maximum input level: +10 dBV (3.162 Vrms)

#### ■ LINE IN 11-16 line inputs (balanced)

(LEVEL switch set to "+4dBu")

Connectors: 6.3mm (1/4") standard TRS jacks

(Tip: HOT, Ring: COLD, Sleeve: GND)

Input impedance: 10 kΩ

Nominal input level: +4 dBu (1.228 Vrms)

Maximum input level: +24 dBu (12.282 Vrms)

---

### Analog outputs

#### ■ LINE OUT 1-8 line outputs (balanced)

Connectors: 6.3mm (1/4") standard TRS jacks

(Tip: HOT, Ring: COLD, Sleeve: GND)

Output impedance: 100 Ω

Nominal output level: +4 dBu (1.228 Vrms)

Maximum output level: +24 dBu (12.277 Vrms)

#### ■ PHONES output

Connector: 6.3mm (1/4") standard stereo jack

Maximum output: 70 mW + 70 mW

(THD+N 1% or less, into 32 Ω load)

#### ■ Frequency response

##### ■ Input → PHONES output

At 44.1 kHz and 48 kHz

20 Hz – 20 kHz: ±1.0 dB (JEITA), supports Hi-Res

At 88.2kHz and 96kHz

20 Hz – 40 kHz: ±2.0 dB (JEITA), supports Hi-Res

---

### Control input/output ratings

#### ■ MIDI IN connector

Connector: 5-pin DIN

Format: standard MIDI

#### ■ MIDI OUT connector

Connector: 5-pin DIN

Format: standard MIDI

#### ■ USB

Connector: 4-pin USB B-type

Transfer rate: USB 2.0 High Speed (480 Mbps)

---

## Audio performance

- **Mic amp EIN (equivalent input noise)**  
–125 dBu or more
- **Frequency response**
- **Input → LINE OUT (BALANCED)**  
At 44.1 kHz and 48 kHz  
20 Hz – 20 kHz: ±0.5 dB (JEITA)  
At 88.2kHz and 96kHz  
20 Hz – 40 kHz: ±0.5 dB (JEITA)
- **S/N ratio**  
100 dB or higher  
(LINE IN → LINE OUT, gain knob at minimum, JEITA)
- **Distortion**  
0.006% or less  
(Mic/LINE IN → LINE OUT, 1kHz sine wave, at nominal input level and maximum output level)
- **Crosstalk**  
100 dB or higher  
(Mic/LINE IN → LINE OUT, 1kHz)

---

## Computer system requirements

Check the TEAC Global Site (<http://teac-global.com/>) for the latest information about supported operating systems.

---

### Windows

- **Supported operating systems**  
Windows 8 (including 8.1) 32-bit  
Windows 8 (including 8.1) 64-bit  
Windows 7 32-bit SP1 or later  
Windows 7 64-bit SP1 or later
- **Computer hardware requirements**  
Windows computer with a USB 2.0 or USB 3.0 port  
Computer
- **CPU/processor speed**  
2 GHz or faster dual core processor (x86)
- **Memory**  
2 GB or more
- **Display resolution**  
At least 1280x800

### CAUTION

*Operation of this unit was confirmed using standard computers that meet the above requirements. This does not guarantee operation with all computers that meet the above requirements. Even computers that meet the same system requirements might have processing capabilities that differ according to their settings and other operating conditions*

---

## Mac OS X

- **Supported operating systems**  
OS X Yosemite (10.10 or later)  
OS X Mavericks (10.9.1 or later)  
OS X Mountain Lion (10.8.4 or later)
- **Computer hardware requirements**  
Apple Macintosh computer with a USB 2.0 or USB 3.0 port
- **CPU/processor speed**  
2 GHz or faster dual core processor
- **Memory**  
2 GB or more
- **Display resolution**  
At least 1280x800

---

## iOS devices

Apple devices running iOS 7 or later

---

## Supported audio drivers

Windows: ASIO2.0, WDM, MIDI  
Mac: Core Audio, Core MIDI

---

## General

- **Power**  
Specialized DC12V AC adapter (GPE248-120200-Z)
- **Power consumption**  
12 W
- **Dimensions (W × H × D)**  
**Standard frame attached** (state when shipped from factory)  
445 × 59 × 219 mm  
**Rack mount adapters attached**  
482.6 × 44 × 218.4 mm
- **Weight**  
2.8 kg
- **Operating temperature range**  
5–35°C (32–104°F)

# 11 – Specifications

## Dimensional drawings

- Standard frame attached (state when shipped from factory)

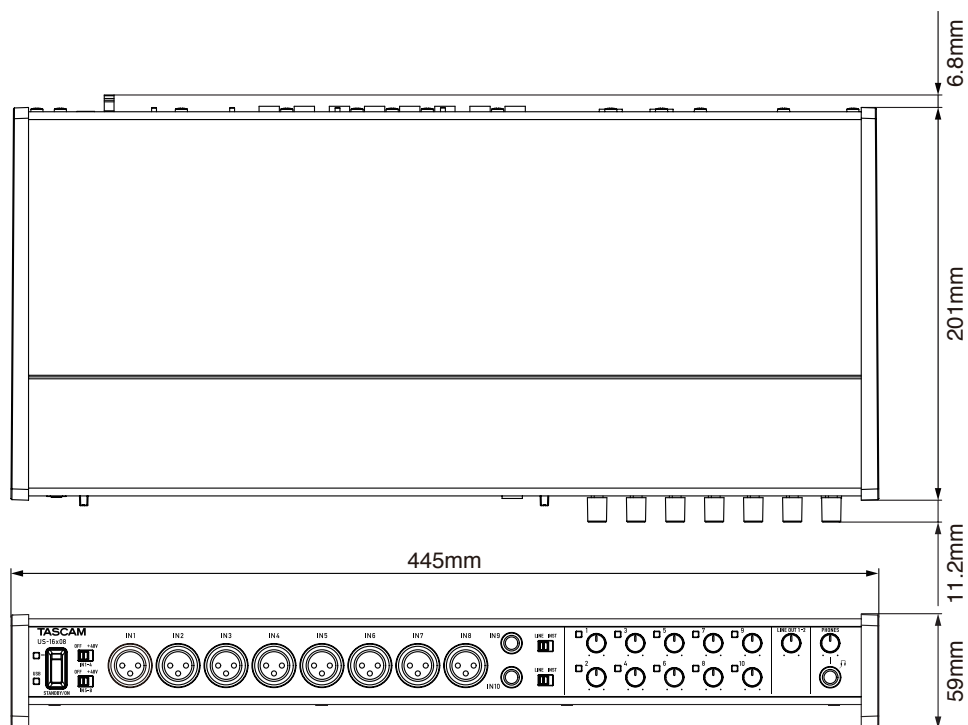

- Rack mount adapters attached

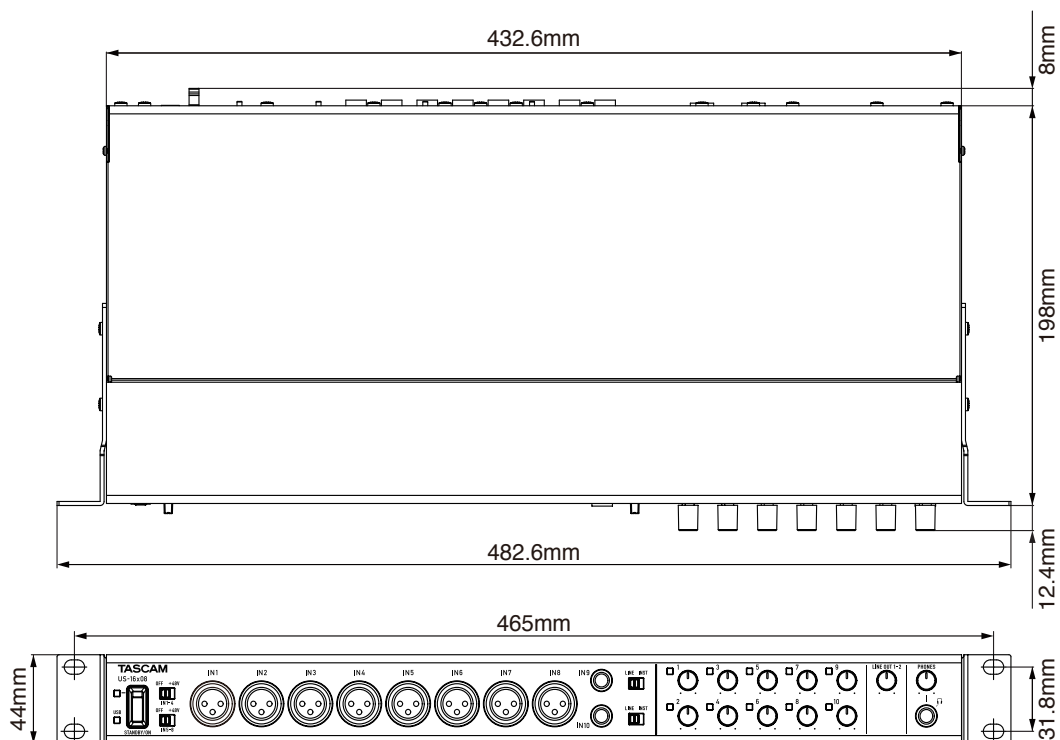

- Illustrations in this manual might differ in part from the actual product.
- The external appearance might be changed without notification to improve the product.

## Block diagrams

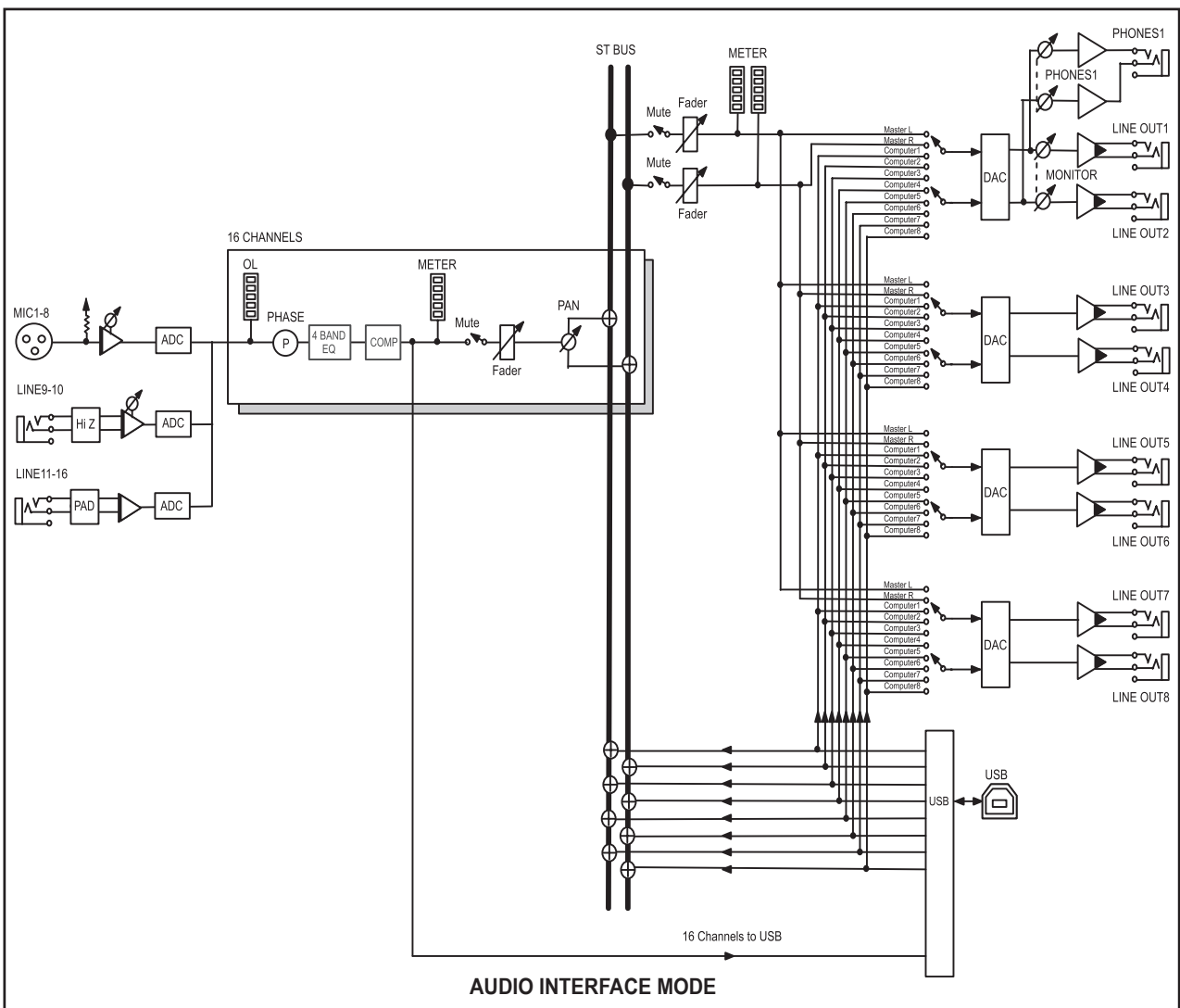
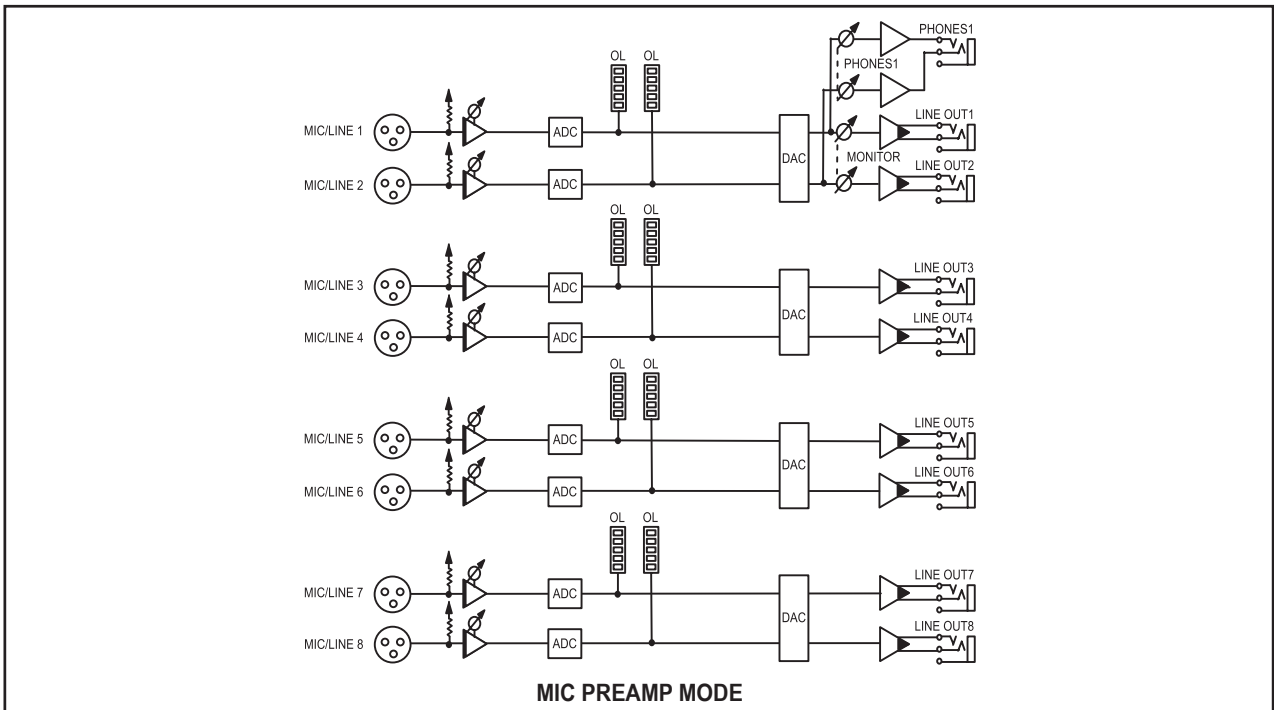

# 11 – Specifications

## Level diagrams

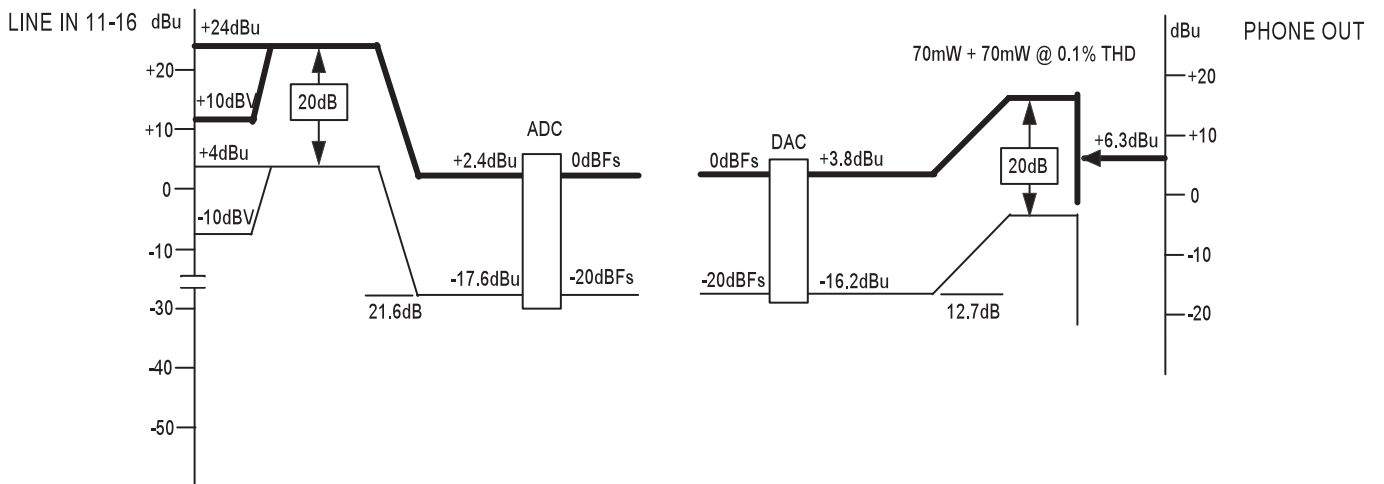
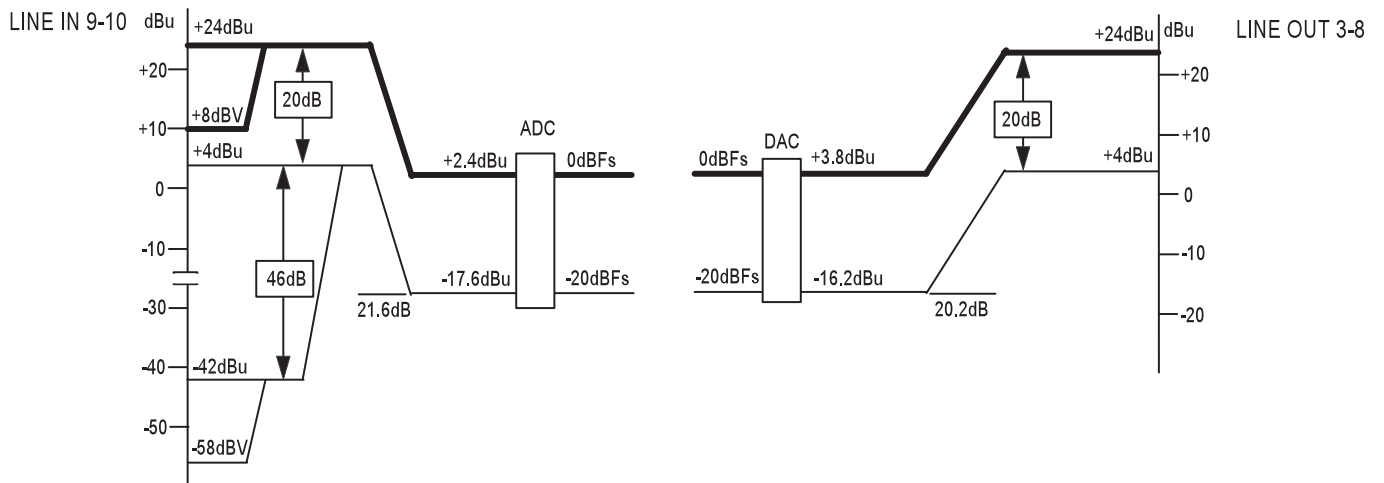
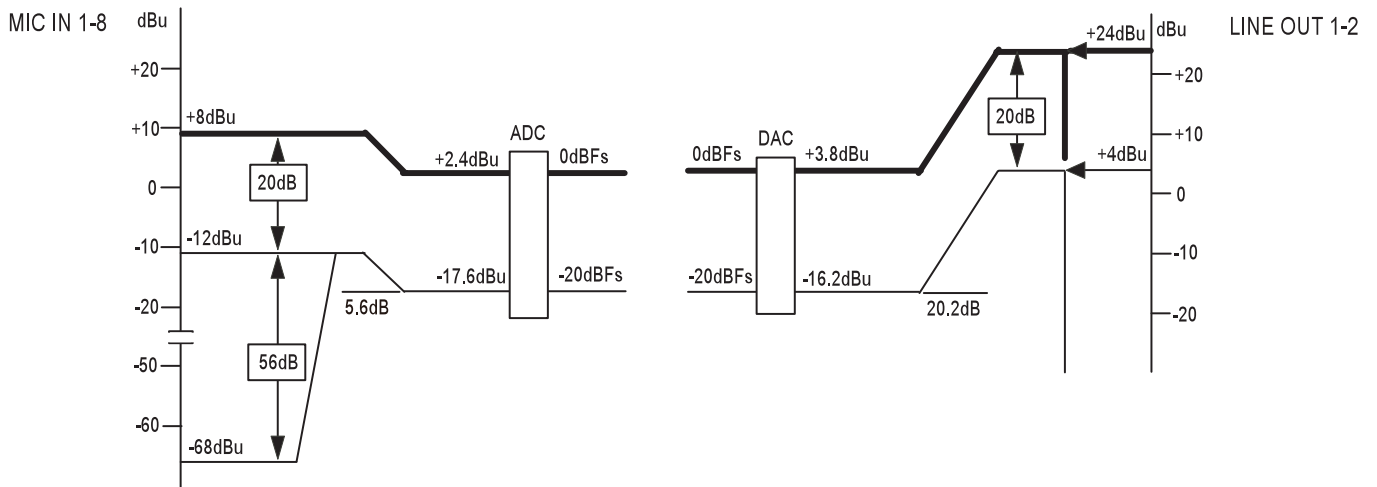

LEVEL DIAGRAM





# TASCAM

---

## TEAC CORPORATION

Phone: +81-42-356-9143  
1-47 Ochiai, Tama-shi, Tokyo 206-8530 Japan

<http://tascam.jp/>

---

## TEAC AMERICA, INC.

Phone: +1-323-726-0303  
1834 Gage Road, Montebello, California 90640 USA

<http://tascam.com/>

---

## TEAC MEXICO, S.A. de C.V.

Phone: +52-55-5010-6000  
Río Churubusco 364, Colonia Del Carmen, Delegación Coyoacán, CP 04100, México DF, México

<http://teacmexico.net/>

---

## TEAC UK LIMITED

Phone: +44-8451-302511  
Meridien House, Ground Floor, 69 - 71, Clarendon Road, Watford, Hertfordshire, WD17 1DS, UK

<http://tascam.eu/>

---

## TEAC EUROPE GmbH

Phone: +49-611-71580  
Bahnstrasse 12, 65205 Wiesbaden-Erbenheim, Germany

<http://tascam.eu/>

---

## TEAC SALES & TRADING(SHENZHEN) CO., LTD

Phone: +86-755-88311561~2  
Room 817, Block A, Hailrun Complex, 6021 Shennan Blvd., Futian District, Shenzhen 518040, China

<http://tascam.cn/>

---