



DH5

DuraPlex™ Omnidirectional Headset

The Shure Omnidirectional DuraPlex Headset user guide.
Version: 1.0 (2020-J)

Table of Contents

DH5 DuraPlex™ Omnidirectional Headset	3	Using the Collar Clip	8
General Description	3	Accessories	8
Features	3	Furnished Accessories	9
Care and Maintenance	3	Optional Accessories	9
		Replacement Parts	9
Adjusting the Headband and Microphone	4	Threaded Mount Instructions	10
Reversing the Boom	5	Wiring and Termination	10
Presence Cap	7	Typical Wiring Table	11
Frequency Response	7	MTQG Connector Assembly	11
Attaching the Windscreen	7	Specifications	12
		Certifications	14

DH5 DuraPlex™ Omnidirectional Headset

General Description

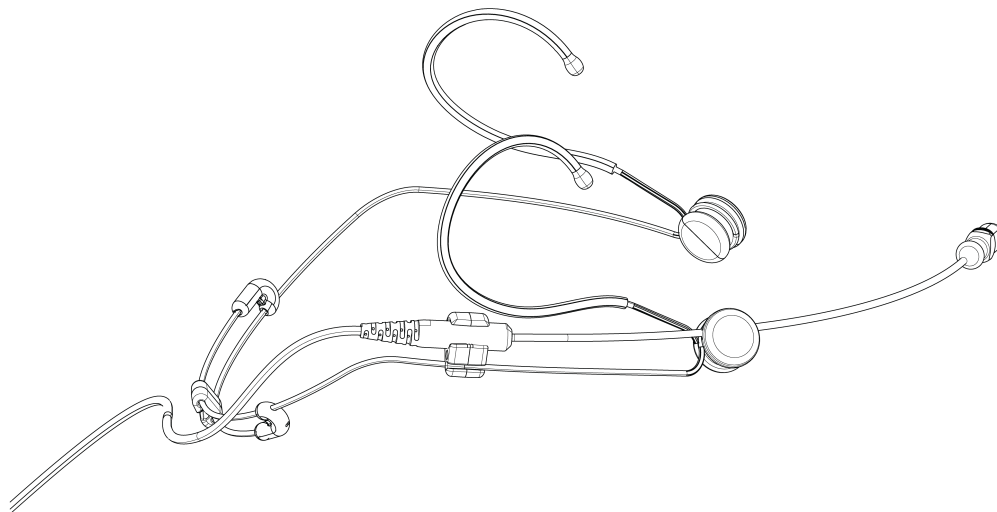

The DuraPlex DH5 omnidirectional headset microphone is ideal for both speech and performance applications that require durability and minimal visibility. The bendable lightweight headset features switchable boom mounting placement and a neutral clear design to be used with any DH5 color variant. The certified IP57 rated headset can withstand challenging conditions involving sweat and dust for use in theater, corporate events, and TV broadcast applications. Each microphone is supplied with a storage pouch, single tie clip, vocal presence frequency response cap, snap fit windscreen, foam windscreen, and TA4F threaded adapter.

Features

- IP57 Certified dust resistant and waterproof/sweatproof headset
- 5mm omnidirectional subminiature design for discrete placement and improved gain before feedback
- 1.6mm PLEX Cable technology, paintable cable, and no memory effect
- Professional sound quality for speech and performance applications
- High RF immunity, compatible with digital wireless systems without RF interference
- Attachable Presence Cap included for tailored frequency response in speech applications
- Included furnished accessories for storage, mounting options, and wind protection
- TA4F and LEMO terminations for variable wireless system connectivity
- Universal clear headset frame with switchable boom mount placement
- Available in Black, Tan, Cocoa finishes

Care and Maintenance

The DuraPlex omnidirectional microphone has been IP57 dust-protected, waterproof rated by extensive internal tests, so you can clean it using distilled water and a mild detergent when necessary.

Adjusting the Headband and Microphone

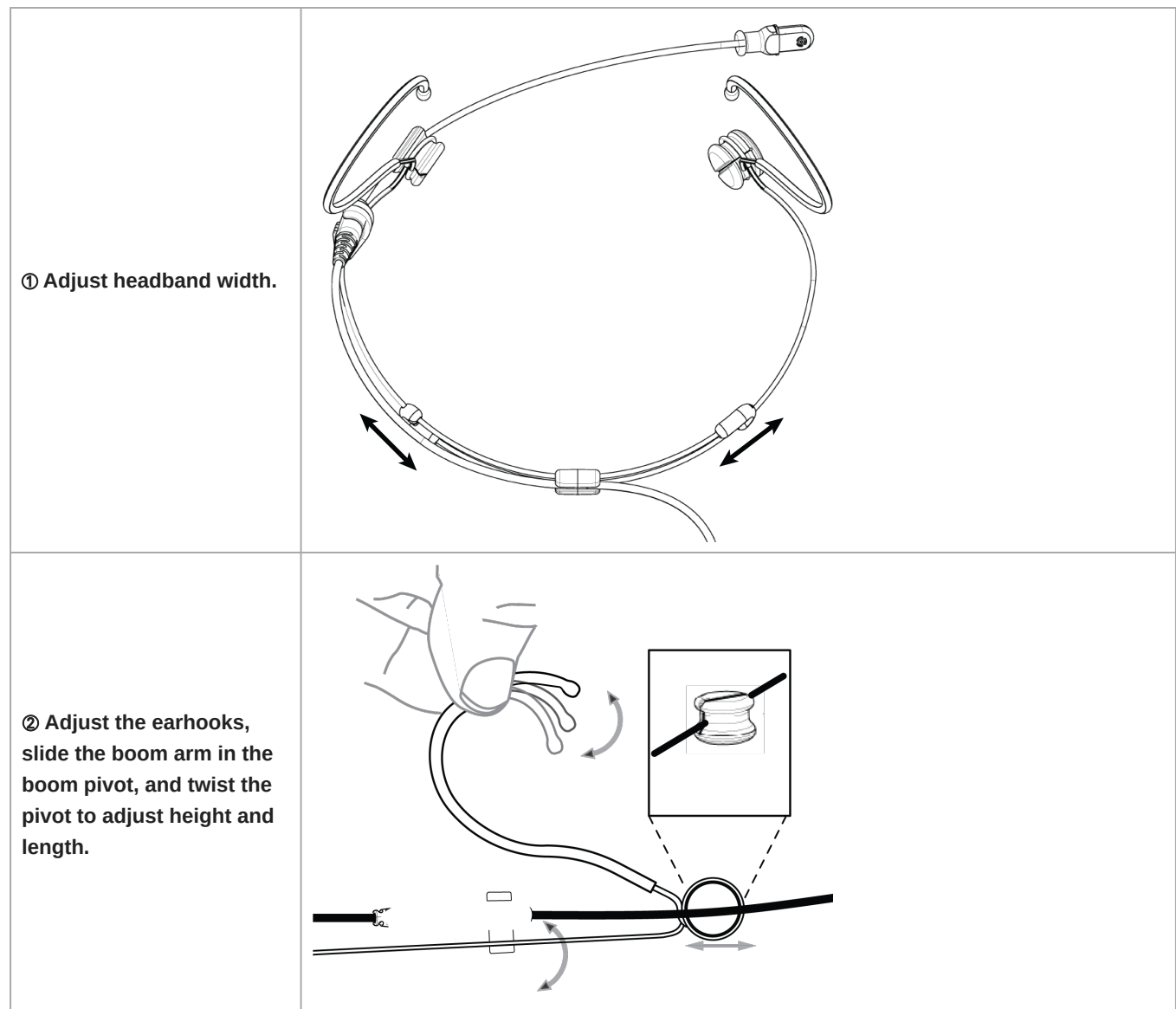

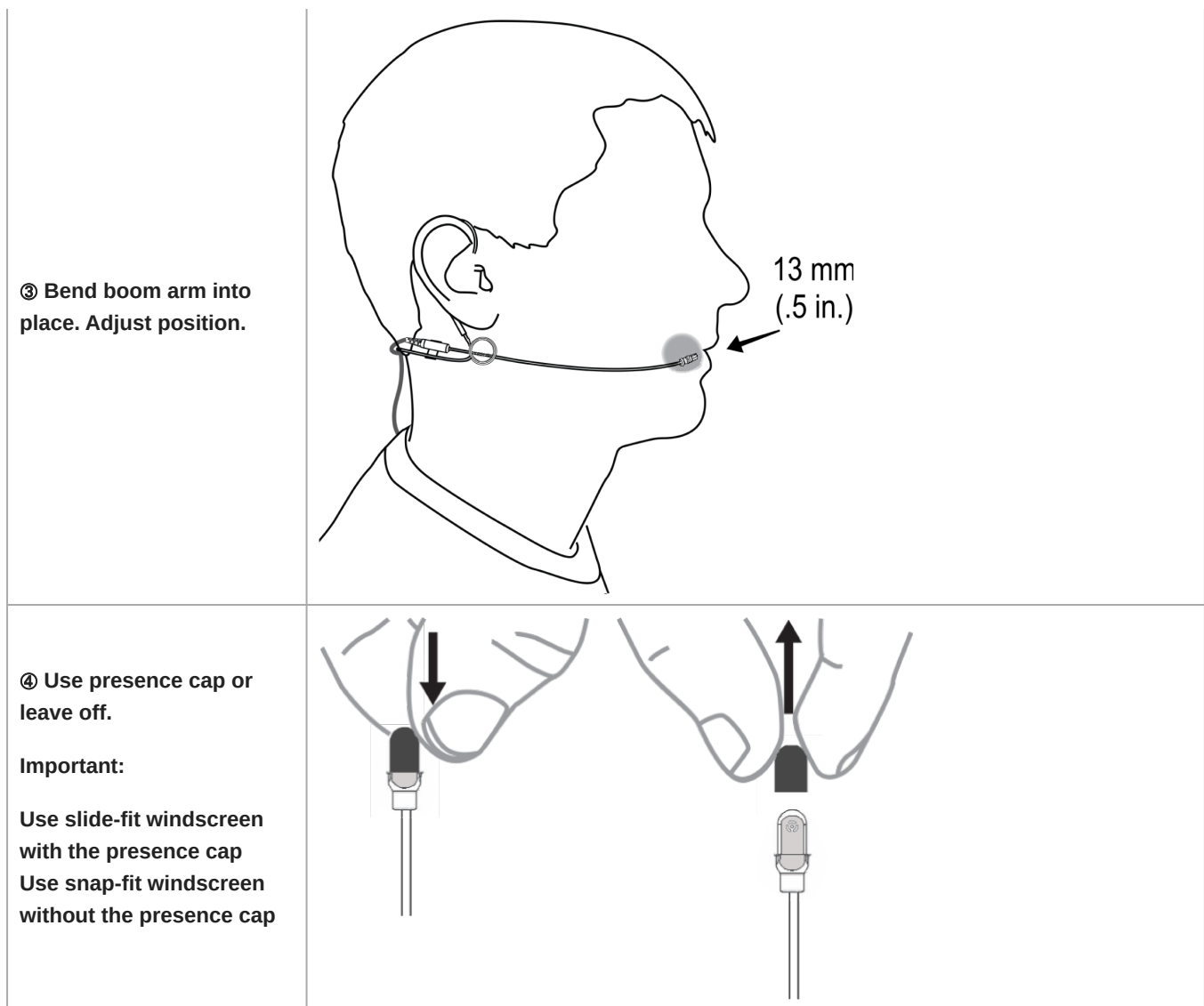

Reversing the Boom

The microphone boom can be positioned on the left or right side of the head.

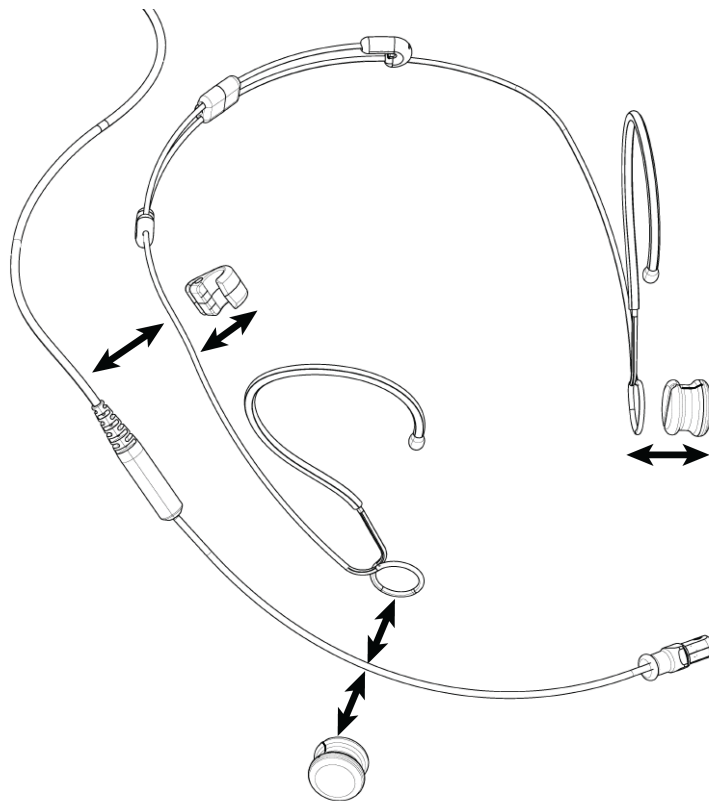
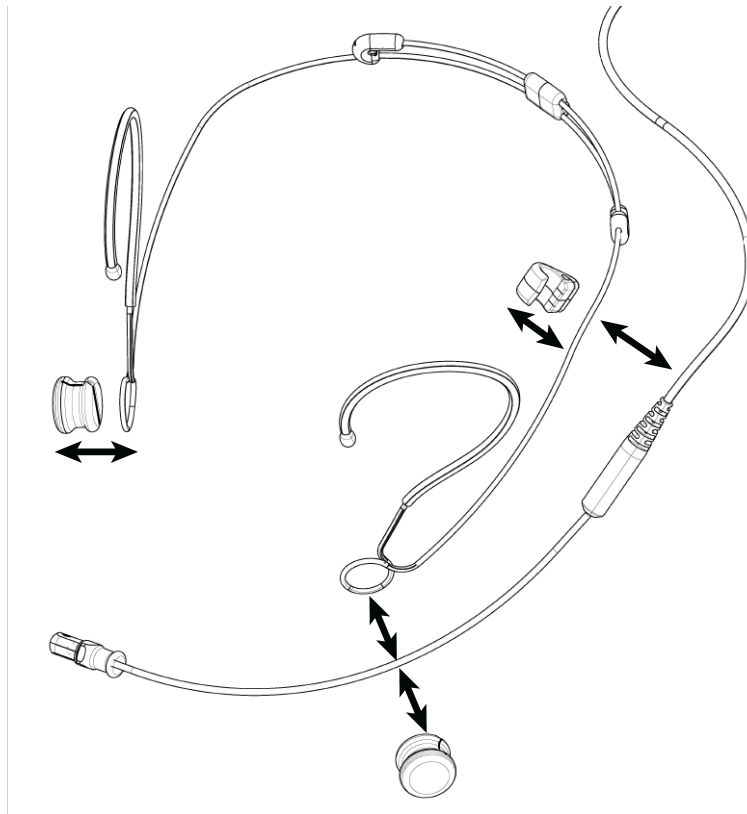

1. Squeeze the earpiece towards the headband.

2. Push out the boom arm and boom pivot.
3. On the other side, repeat the steps to remove the boom pivot.
4. Move the boom arm to the preferred side, ensuring that the boom arm is placed in the slot in the boom pivot.
5. Squeeze each earpiece towards the headband to push boom pivots back into place.

Presence Cap

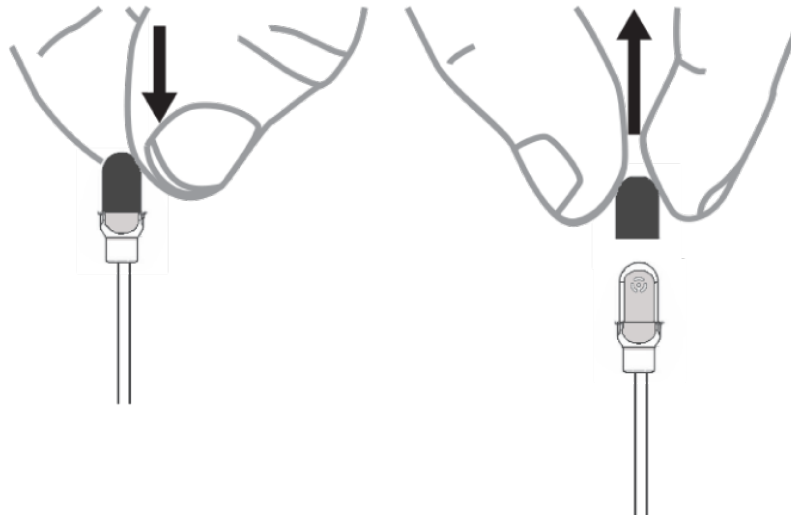

Frequency Response

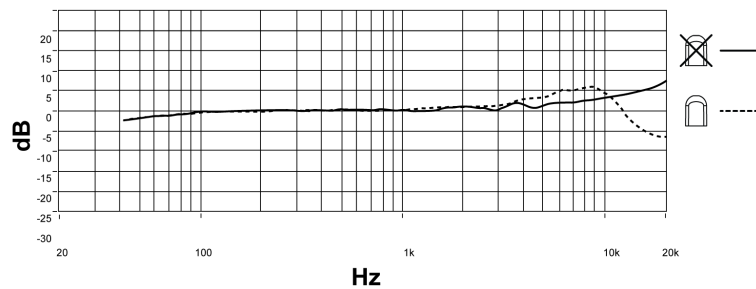

Attaching the Windscreen

There are two windscreens for use with the DuraPlex microphone:

1. A slide-fit windscreen for use with the presence cap

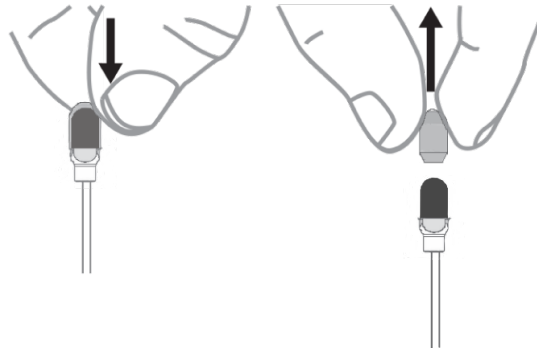

2. A snap-fit windscreen for use without the presence cap

Note: Do not use the snap-fit windscreen with the presence cap--the presence cap can become caught inside the snap-fit windscreen.

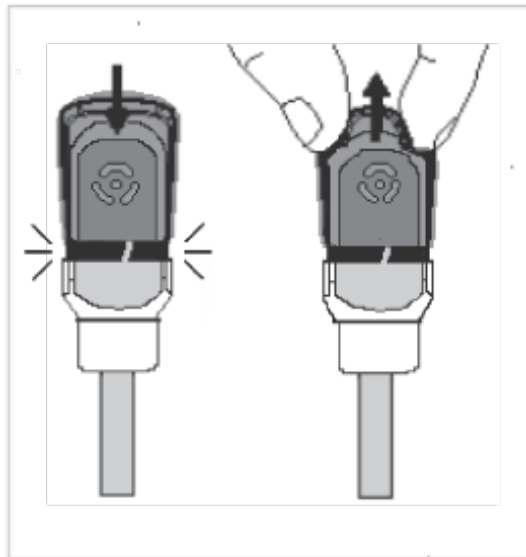

Using the Collar Clip

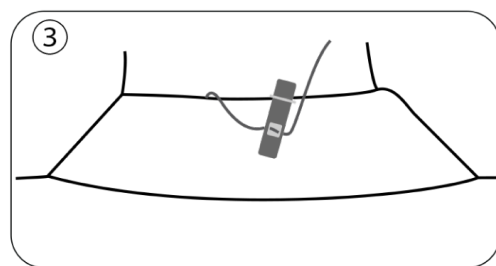
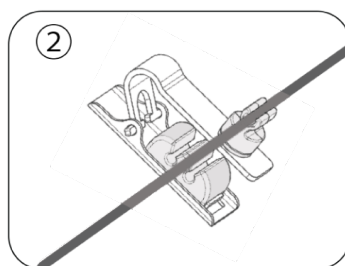
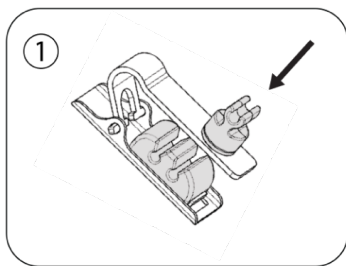

Accessories

Furnished Accessories

Furnished Accessories	DH5 Black	DH5 Tan	DH5 Cocoa
Single Tie Clip	95A43715	95A43715	95A43715
Presence Cap	65A44182	65B44182	65C44182
Snap-Fit Windscreen	95A16167	95B16167	95C16167
Foam Windscreen	95A43438	95B43438	95C43438
Sticky Mount	66A44183	66A44183	66A44183
Case	95A44075	95A44075	95A44075
Threaded TA4F Adapter	95A29490	95A29490	95A29490

Accessories are available in Black (B), Tan (T), AND Cocoa (C) color varieties. Please consult your Shure representative for available options.

Optional Accessories

TA4F/TQG XLR Preamp	RPM400TQG
Lemo XLR Preamp	RPM400LEMO

Replacement Parts

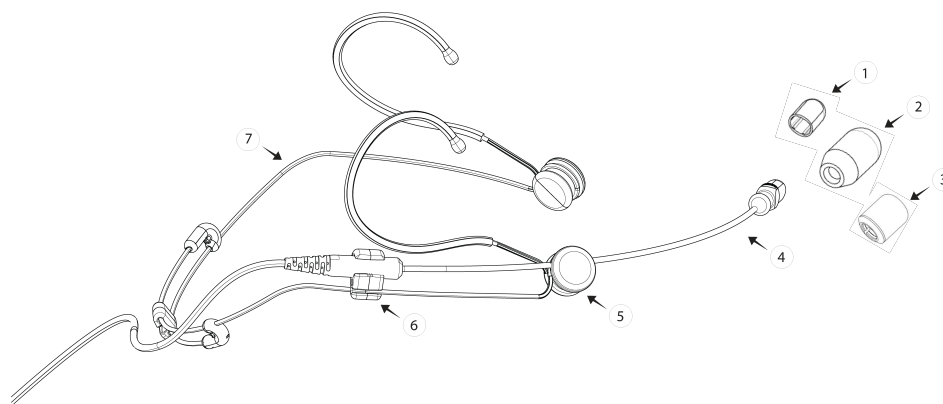

	Description	Black	Tan	Cocoa
1	Presence Cap, qty. 5	RPMDL4FC/B	RPMDL4FC/T	RPMDL4FC/C
2	Foam Windscreen, qty. 3	RPMDL4WS/B	RPMDL4WS/T	RPMDL4WS/C
3	Snap-fit Windscreen, qty. 3	RPMDL4SFWS/B	RPMDL4SFWS/T	RPMDL4SFWS/C

	Description	Black	Tan	Cocoa
4	Microphone Boom Arm and Cable Assembly, Lemo Connector	RPMDH5B/O-LM3	RPMDH5T/O-LM3	RPMDH5C/O-LM3
	Microphone Boom Arm and Cable Assembly, MTQG Connector	RPMDH5B/O-MTQG	RPMDH5T/O-MTQG	RPMDH5C/O-MTQG
5	Boom Pivot, qty. 4	RPMDH5PIVOT	RPMDH5PIVOT	RPMDH5PIVOT
6	Boom Mount, qty. 4	RPMDH5BM	RPMDH5BM	RPMDH5BM
7	Headset Frame, qty. 1	RPMDHSF	RPMDHSF	RPMDHSF
	Single Tie Clip, qty. 3	RPMDL4STC/B	RPMDL4STC/T	RPMDL4STC/C
	Dual Tie Clip, qty. 3	RPMDL4DTC/B	RPMDL4DTC/T	RPMDL4DTC/C
	DL4 Sticky Mount, qty. 3	RPMDL4SM	RPMDL4SM	RPMDL4SM
	DH5 Case, Headset	RPMDH5CASE	RPMDH5CASE	RPMDH5CASE
	TA4F XLR Preamp	RPM400TQG	RPM400TQG	RPM400TQG
	LEMO XLR Preamp	RPM400LEMO	RPM400LEMO	RPM400LEMO

Threaded Mount Instructions

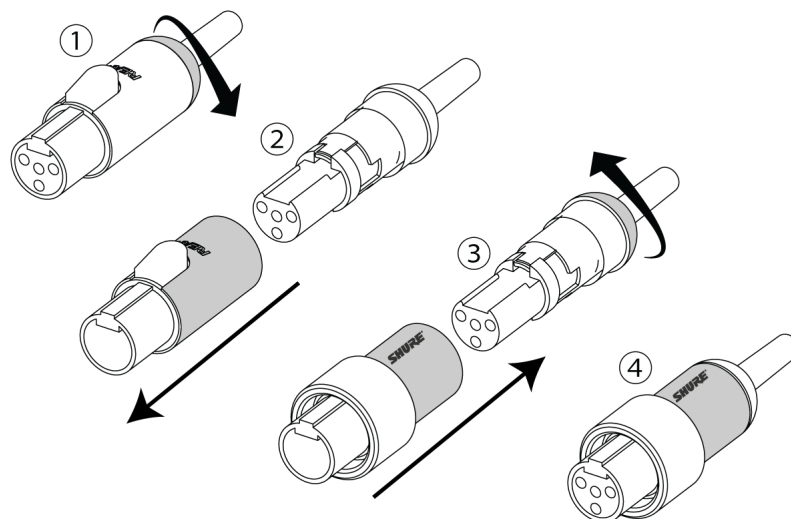

Wiring and Termination

Typical Wiring Table

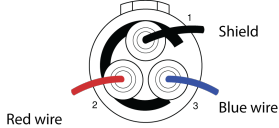
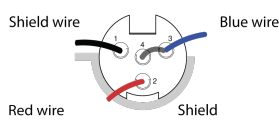
Series	Cable Construction	Electrical Design	Polarity	Replacement Connector	For Use With	Wiring	Line Art (From Solder Side)
DL4-LEMO	1.6mm cable with single conductor and shield	3 wire with additional bias on pin 3	Positive with respect to ground	WA416	Shure Lemo Bodypacks (AD1/ADX1-Lemo, Shure UR1M-Lemo, ULXD1-Lemo)	Red wire: Audio/Bias(2) Blue wire: Audio(3) Shield: Ground(1)	
DL4-MTQG	1.6mm cable with 2 conductors, 2 shield wires and shield	3-Wire	Positive with respect to ground	WA430	All Shure TA4F Bodypacks	Red wire: Bias(2) Blue wire: Audio(3) Shield wire: Ground(1) Shield: Ground (Shell)	

Note: The conductors have a black, protective coating that you must remove with isopropyl alcohol to see their actual color.

MTQG Connector Assembly

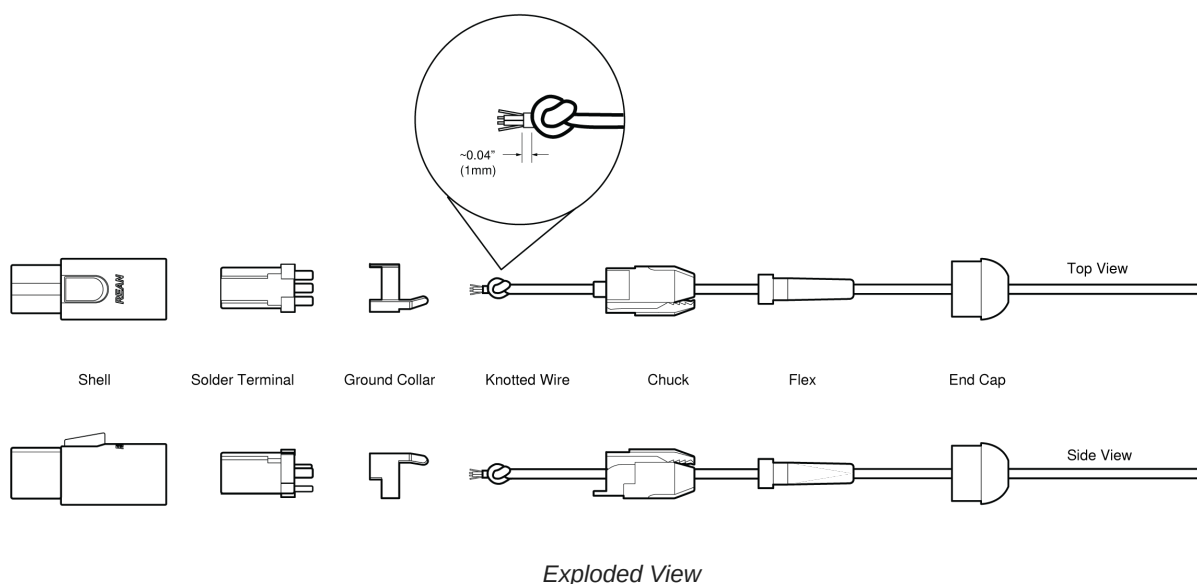

Note: Make sure to solder the shield to ground collar.

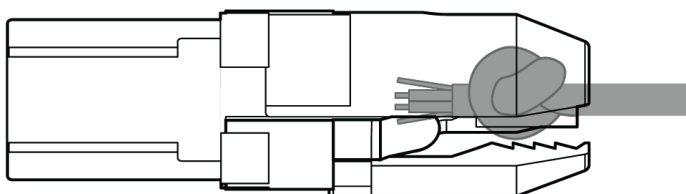

Assembled View

Specifications

Note:

- All specification values are based on using a typical bodypack with 5 V bias input or the RPM400MTQG preamplifier. When using the RPM400LEMO amplifier, refer to the RPM400LEMO specifications.
- All specifications measured with a 48 Vdc phantom power supply. The microphone operates at lower voltages, but with slightly decreased headroom and sensitivity.

Microphone Capsule

MEMS

Polar Pattern

Omnidirectional

Frequency Response

20 Hz to 20 kHz

Sensitivity

-42.5 dBV at 1 kHz ^[1]

Self-Noise, A-Weighted, Equivalent Acoustical

31 dB SPL-A

Signal-To-Noise Ratio ^[2]

63.0 dB

Maximum SPL ^[3]

132.0 dB SPL, 1 kHz at 1% THD, typical

Dynamic Range

101.0 dB typical

Microphone Current Draw

220 μ A, maximum

Bias Voltage

Recommended Operating Voltage

5 V DC, 2.6 V DC minimum

Housing

Molded ABS

Polarity

MTQG	Positive pressure on diaphragm produces positive voltage on pin 3 with respect to pin 1
LEMO	Positive pressure on diaphragm produces positive voltage on pin 3 with respect to pin 1

Cable Diameter

1.6 mm

Cable Length

66 in. (1.67 m)

Net Weight

DL4	15.0 g(0.53 oz.)
DH5	20.0 g(0.7 oz.)

^[1]1 Pa=94 dB SPL^[2]

S/N ratio is the difference between 94 dB SPL and equivalent SPL of self noise, A-weighted

^[3]

THD of microphone preamplifier when applied input signal level is equivalent to cartridge output at specified SPL

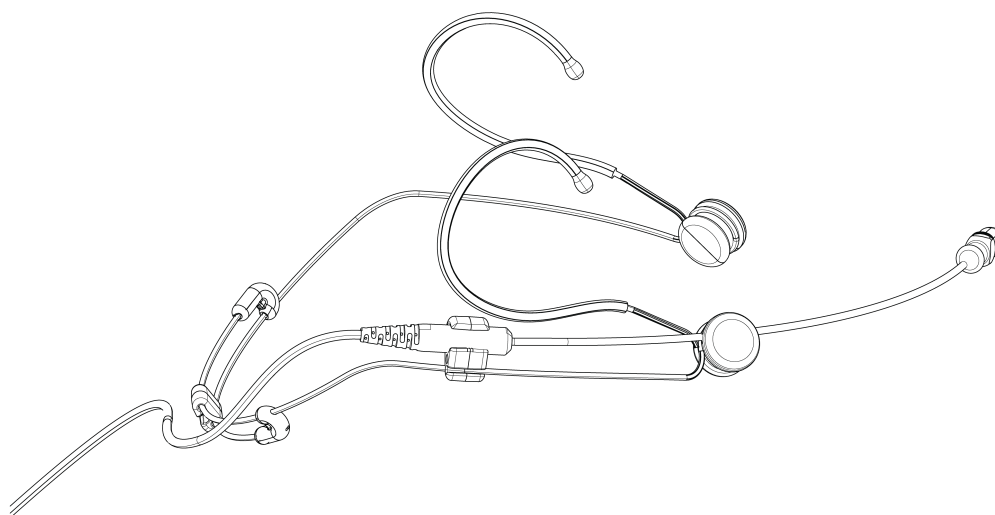

Dimensions

	Cable Length	Cable Diameter	Microphone Length	Microphone Diameter	Boom Length
DH5-MTQG, DH5-LEMO	66 in. (1.67M)	1.6MM	14.5MM	5.2MM	13.6CM

Certifications

This product meets the Essential Requirements of all relevant European directives and is eligible for CE marking.

The CE Declaration of Conformity can be obtained from: www.shure.com/europe/compliance

Authorized European representative:

Shure Europe GmbH

Headquarters Europe, Middle East & Africa

Department: EMEA Approval

Jakob-Dieffenbacher-Str. 12

75031 Eppingen, Germany

Phone: +49-7262-92 49 0

Fax: +49-7262-92 49 11 4

Email: info@shure.de