

BLIMP

Suspension Windshield System

PRODUCT MANUAL



RØDE[®]
MICROPHONES



BLIMP

Suspension Windshield System

PRODUCT MANUAL



RØDE[®]
MICROPHONES



The RØDE Blimp

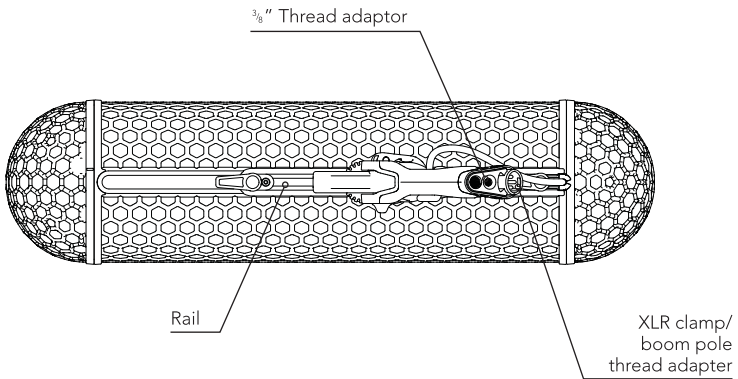
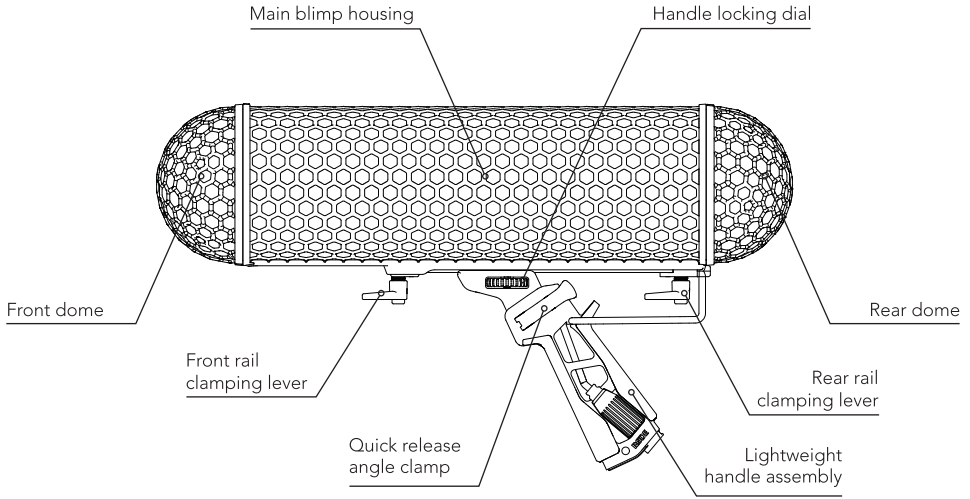

The RØDE Blimp

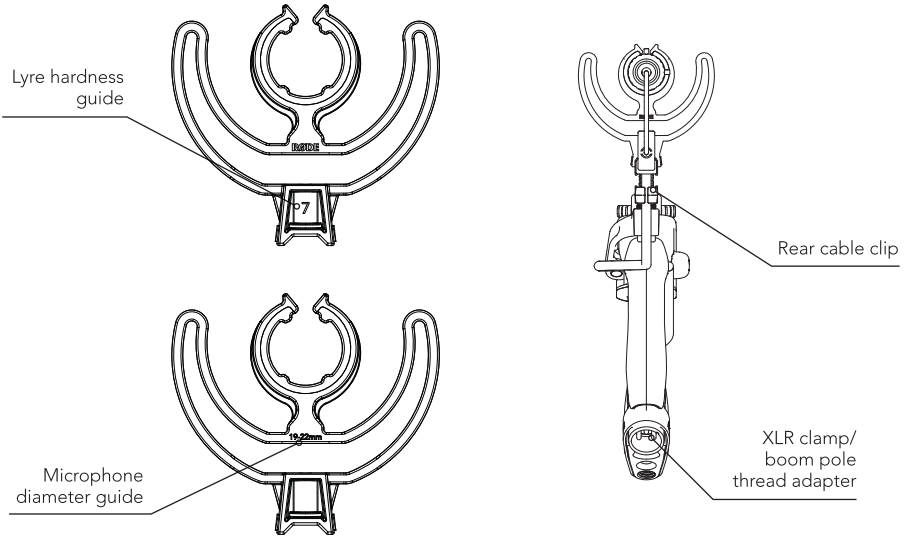
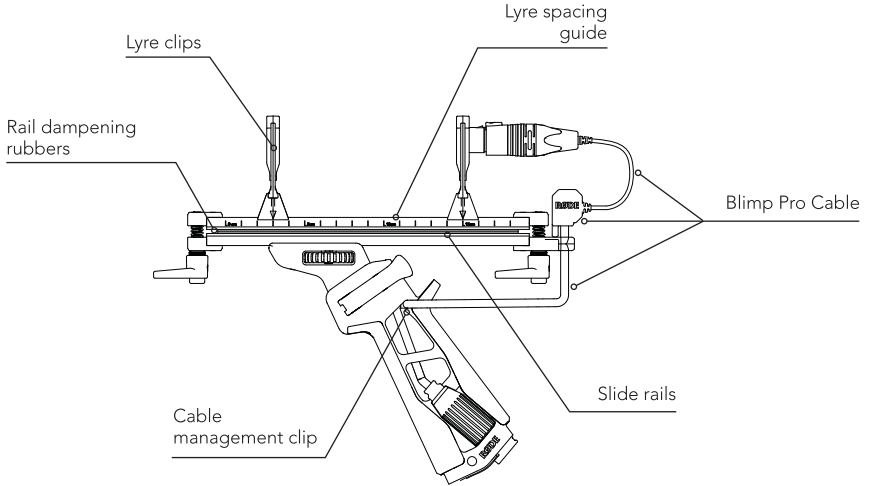

Included Accessories

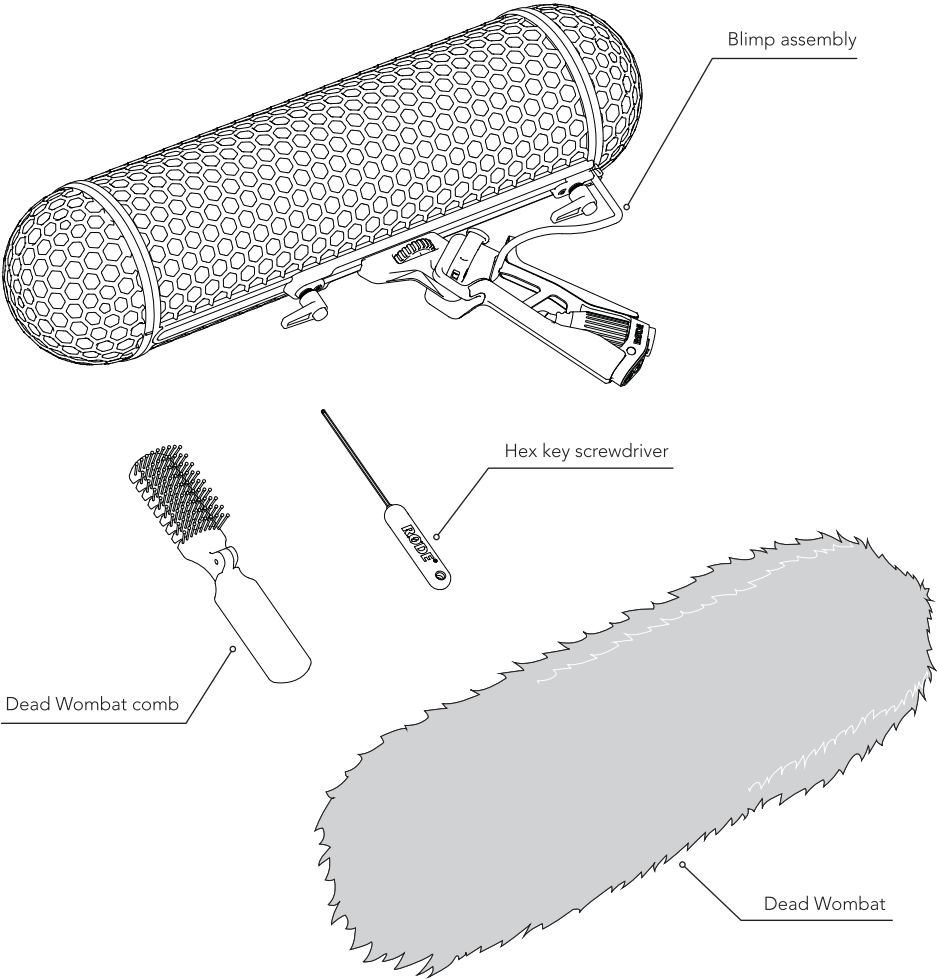

Adjusting the handle

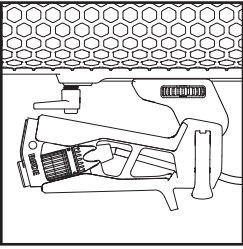

As the RØDE Blimp ships with the handle collapsed and a loose angle-clamp setting, you will need to adjust the strength of the handle angle setting by following the instructions below.

It is recommended that you collapse the handle during transportation and storage.

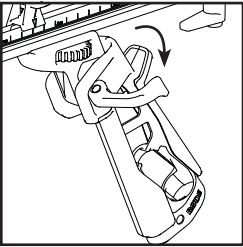

1. Open the 'quick release' angle clamp on the left hand side of the handle, and move the handle to the desired angle.

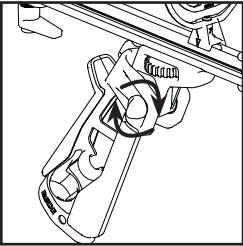

2. Tighten the angle clamp tension screw on the right hand side of the handle to increase the tension of the quick release clamp.

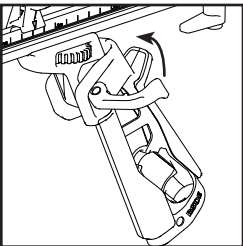

3. Close the angle clamp on the left hand side of the handle to lock it in place.

Adjusting the handle

The handle can be relocated along the rails to a position that offers the best weight balance & handling for the installed microphone.

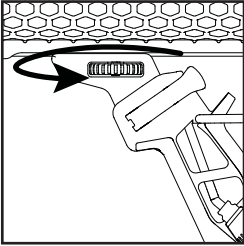

1. To relocate the handle, first turn the handle locking dial to the left several times to loosen the handle.

Ensure that you are supporting the blimp housing so that it does not become unstable if the locking dial is overly loosened.

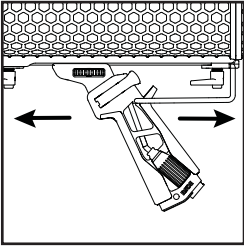

2. The handle can now be easily slid up or down the rail to achieve the desired balance.

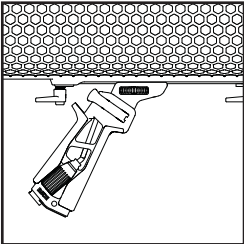

3. In addition to moving along the rail, the handle can also be rotated 180° for greater flexibility of use.

Note that you may have to loosen the handle locking dial several turns to allow the handle to rotate.

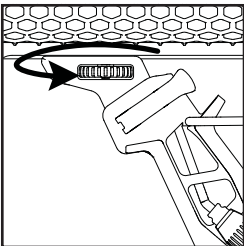

4. Turn the handle locking dial clockwise to tighten.

Inserting your microphone

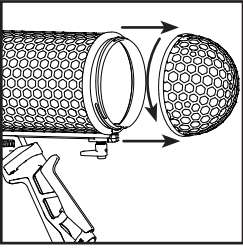

1. Unscrew and remove the rear dome.

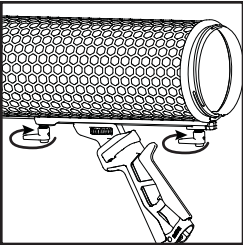

2. Loosen the front and rear rail clamping levers (approximately 1-2 turns).

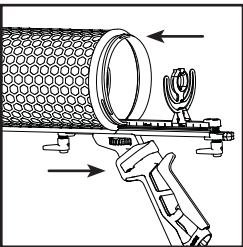

3. Slide the suspension body out of the main Blimp housing.

(To achieve optimum balance and isolation, you may need to adjust the location of the Lyre clips. Instructions for this can be found later in the manual.)

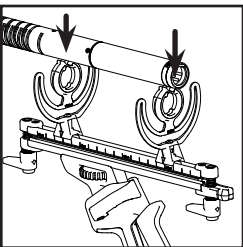

4. Place your microphone above the Lyre clips and gently push the microphone body into the Lyre clips, checking that the microphone is secure.

Inserting your microphone

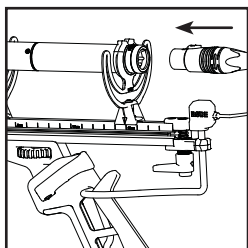

5. Plug the Blimp Pro Cable into the XLR socket of your microphone.

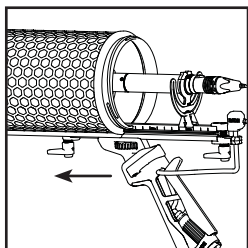

6. Taking care to align the rails with the main Blimp housing, slide the suspension assembly back in to the main Blimp housing.

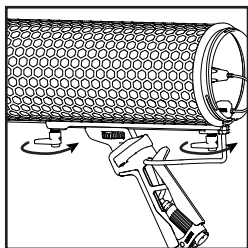

7. Tighten the front and rear rail clamping levers.

Note that the tightening angle of each lever can be adjusted independently of the screw mechanism, simply by pulling the lever downwards and rotating to the desired angle.

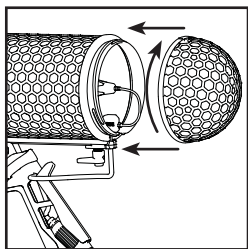
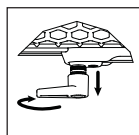

8. Screw the rear dome back in to place.

Adjusting the suspension mounts

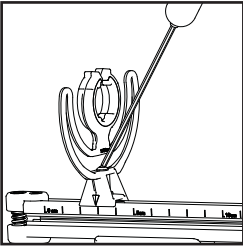

Some microphones will require the Lyre clips to be shifted forwards or backwards along the rail. To adjust the position of the Lyre clips, follow the instructions below.

1. Using the supplied 2mm hex screwdriver, loosen the clamp screw on the Lyre clip (no more than 2-3 turns should be necessary).

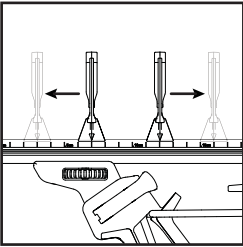

2. Holding the base of the Lyre clip and the rail, gently slide the Lyre clip to the desired location.

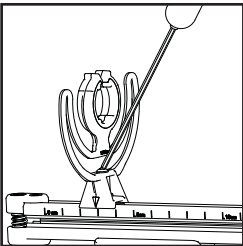

3. Ensuring that the Lyre clip is centred and sitting straight up-and-down on the rail, re-tighten the clamp screw.

Removing pre-installed cable

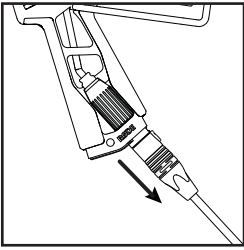

1. To remove the pre installed Blimp Pro Cable, first unplug any cables that are currently connected.

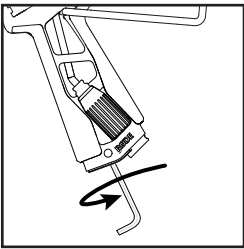

2. Using a 3mm hex key, unscrew the embedded XLR clamp/thread adapter, and remove it from the handle assembly.

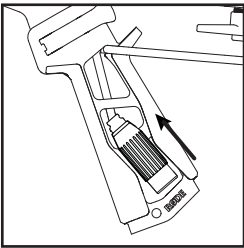

3. Remove the XLR cable from the handle by sliding upwards then through the handle as necessary to release the cable.

Fitting a cable

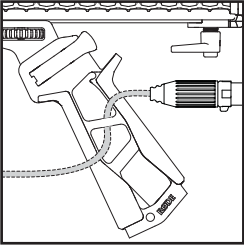

1. Insert the cable through the handle assembly so that the cable is routed as shown

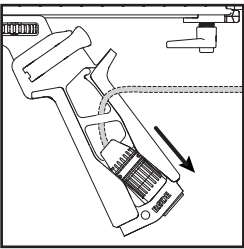

2. Insert the Male XLR end into the base of the handle as shown, with the end slightly protruding

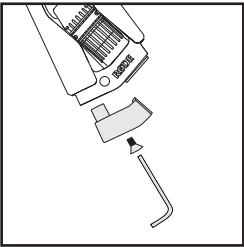

3. Secure the XLR cable in place using the XLR/Boompole Adapter, tightening the screw using a 3mm hex key.

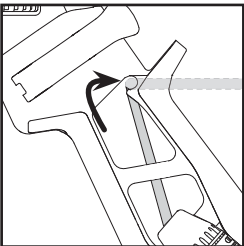

4. Secure the cable using the cable management clip at the top of the handle.

Fitting a cable

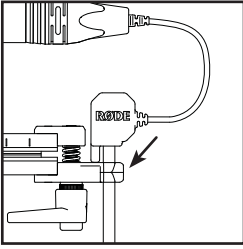

5. If using the Blimp Pro Cable, secure the cable in place using the cable grommet at the rear of the rails, ensuring that the orientation matches the image shown.

If using a cable other than the one supplied with your Blimp, simply secure it in place using the cable grommet, ensuring there is enough room for correct fitment of the rear dome.

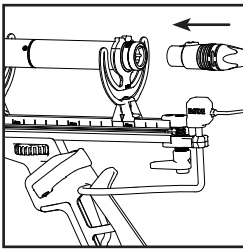

6. Connect the cable to the microphone and adjust the handle to the desired angle for use.

Using the 'Dead Wombat'

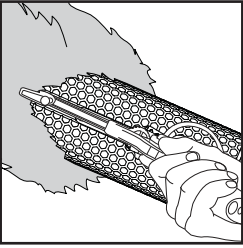

1. Insert the Blimp head-first, taking care to align the seam on the dead wombat with the rail on the underside of the Blimp.

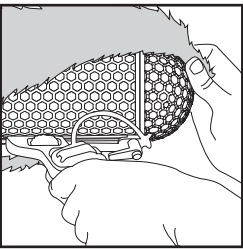

2. Loosen the drawstring on the dead wombat and carefully stretch the dead wombat over the rear dome.

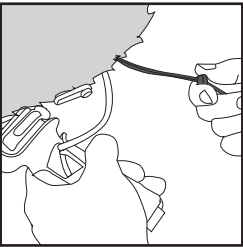

3. Straighten the dead wombat, then tighten and lock the drawstring.

It is recommended that you hook the drawstring over the front rail clamping lever to prevent any handling noise.



4. Brush the dead wombat from front to back to lift the hair and prevent matting.

This greatly assists in wind noise protection as well as extends the life of the dead wombat.

Laundering Instructions for Dead Wombat

We recommend that the DeadWombat be dry cleaned, however it can be hand washed in mild soapy water, rinsed well and air dried.

Once dry, thoroughly comb the synthetic fur to remove any knots and maximise product life.



RØDE[®]
MICROPHONES



Australia

107 Carnarvon st, Silverwater NSW 2128 Australia
Ph: +61 2 9648 5855 Fx: +61 2 9648 2455

USA

PO Box 4189, Santa Barbara CA 93140 USA
Ph: +1 805 566 7777 Fx: +1 805 566 0071

The RØDE Blimp

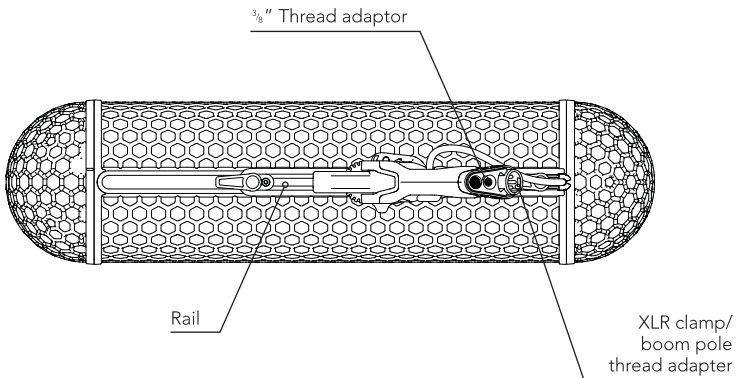
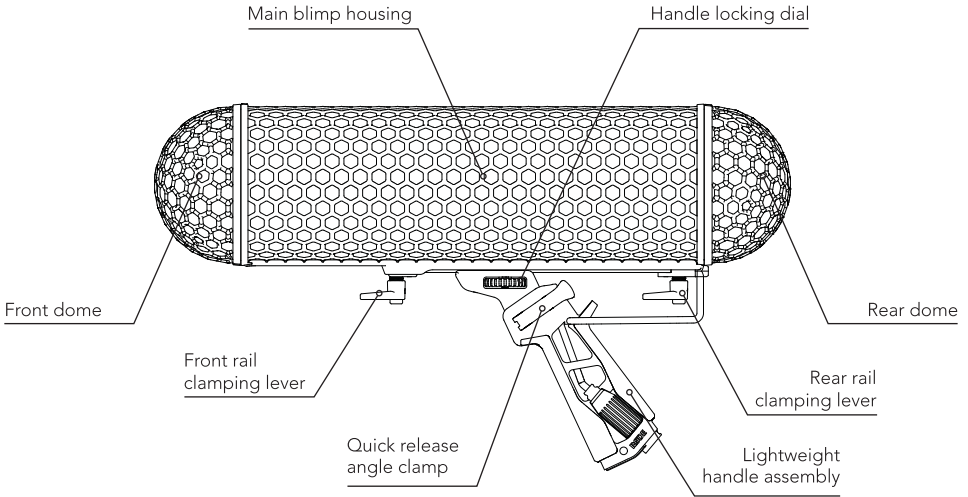

The RØDE Blimp

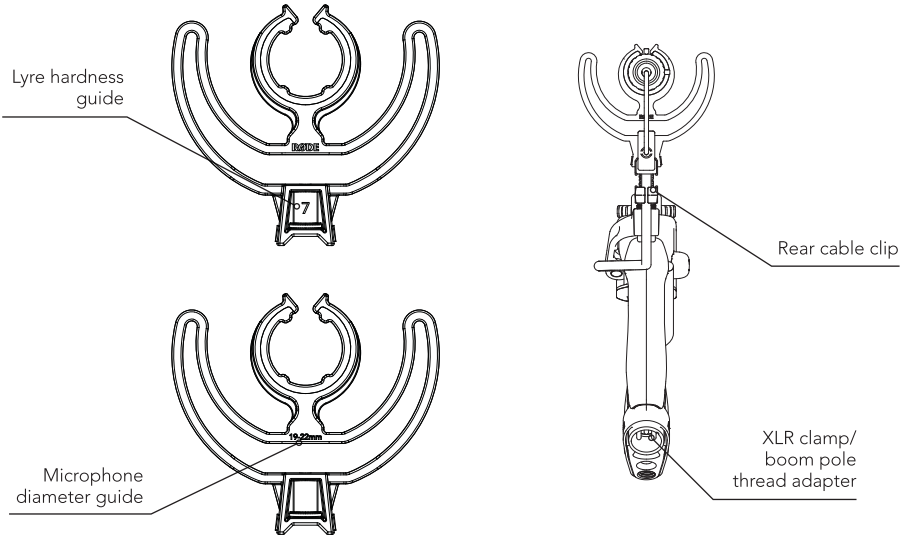
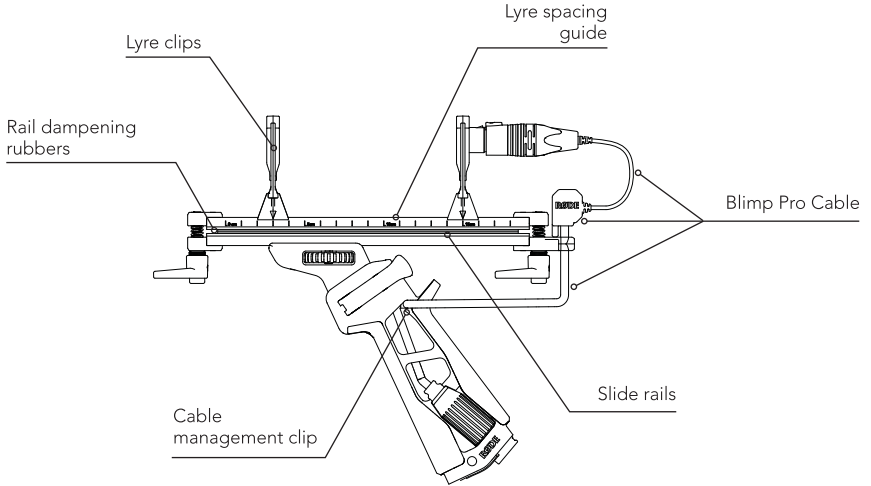

Included Accessories

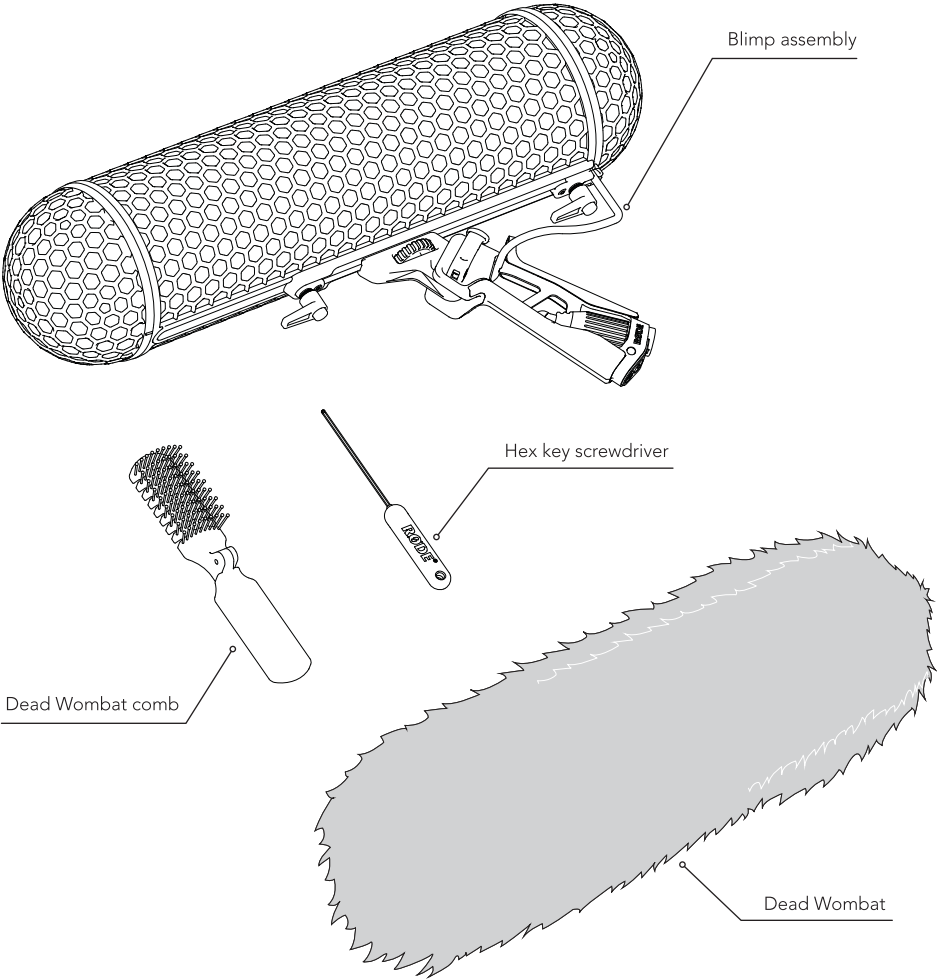

Adjusting the handle

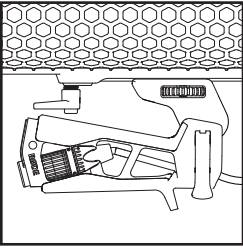

As the RØDE Blimp ships with the handle collapsed and a loose angle-clamp setting, you will need to adjust the strength of the handle angle setting by following the instructions below.

It is recommended that you collapse the handle during transportation and storage.

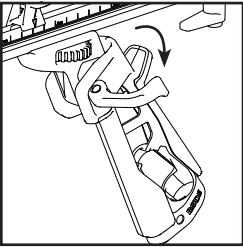

1. Open the 'quick release' angle clamp on the left hand side of the handle, and move the handle to the desired angle.

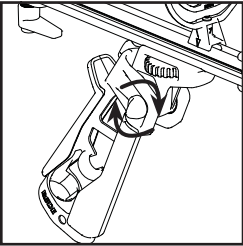

2. Tighten the angle clamp tension screw on the right hand side of the handle to increase the tension of the quick release clamp.

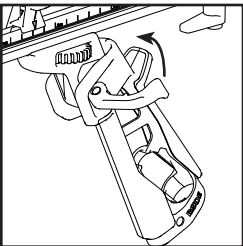

3. Close the angle clamp on the left hand side of the handle to lock it in place.

Adjusting the handle

The handle can be relocated along the rails to a position that offers the best weight balance & handling for the installed microphone.

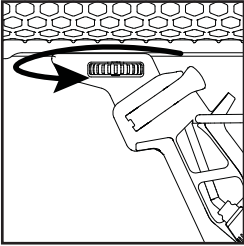

1. To relocate the handle, first turn the handle locking dial to the left several times to loosen the handle.

Ensure that you are supporting the blimp housing so that it does not become unstable if the locking dial is overly loosened.

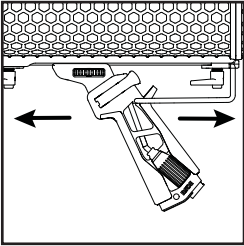

2. The handle can now be easily slid up or down the rail to achieve the desired balance.

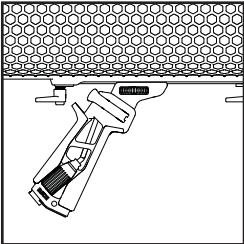

3. In addition to moving along the rail, the handle can also be rotated 180° for greater flexibility of use.

Note that you may have to loosen the handle locking dial several turns to allow the handle to rotate.

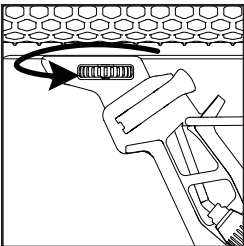

4. Turn the handle locking dial clockwise to tighten.

Inserting your microphone

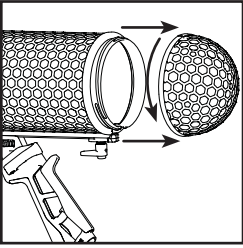

1. Unscrew and remove the rear dome.

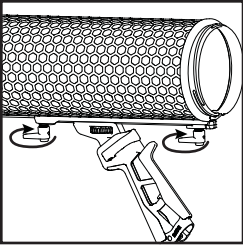

2. Loosen the front and rear rail clamping levers (approximately 1-2 turns).

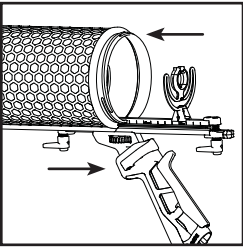

3. Slide the suspension body out of the main Blimp housing.

(To achieve optimum balance and isolation, you may need to adjust the location of the Lyre clips. Instructions for this can be found later in the manual.)

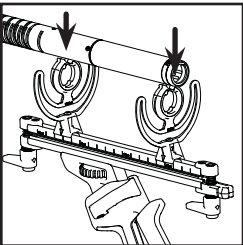

4. Place your microphone above the Lyre clips and gently push the microphone body into the Lyre clips, checking that the microphone is secure.

Inserting your microphone

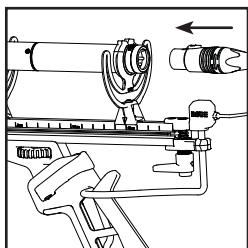

5. Plug the Blimp Pro Cable into the XLR socket of your microphone.

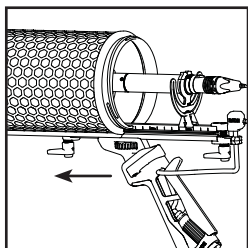

6. Taking care to align the rails with the main Blimp housing, slide the suspension assembly back in to the main Blimp housing.

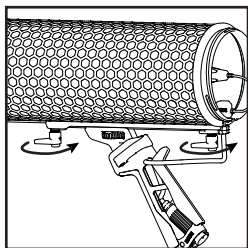

7. Tighten the front and rear rail clamping levers.

Note that the tightening angle of each lever can be adjusted independently of the screw mechanism, simply by pulling the lever downwards and rotating to the desired angle.

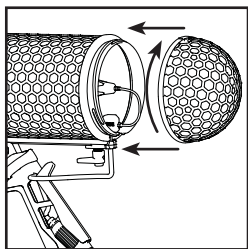
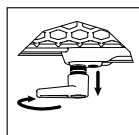

8. Screw the rear dome back in to place.

Adjusting the suspension mounts

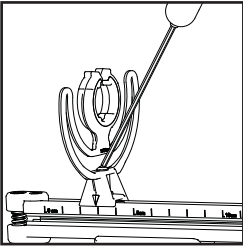

Some microphones will require the Lyre clips to be shifted forwards or backwards along the rail. To adjust the position of the Lyre clips, follow the instructions below.

1. Using the supplied 2mm hex screwdriver, loosen the clamp screw on the Lyre clip (no more than 2-3 turns should be necessary).

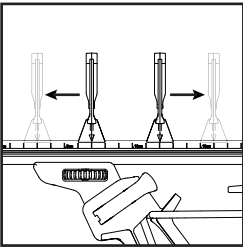

2. Holding the base of the Lyre clip and the rail, gently slide the Lyre clip to the desired location.

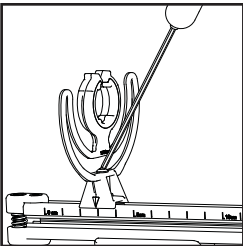

3. Ensuring that the Lyre clip is centred and sitting straight up-and-down on the rail, re-tighten the clamp screw.

Removing pre-installed cable

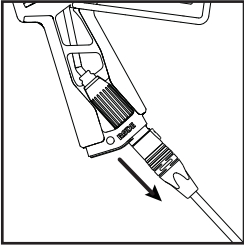

1. To remove the pre installed Blimp Pro Cable, first unplug any cables that are currently connected.

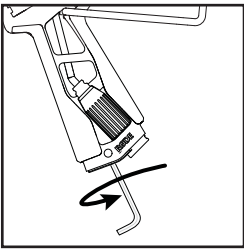

2. Using a 3mm hex key, unscrew the embedded XLR clamp/thread adapter, and remove it from the handle assembly.

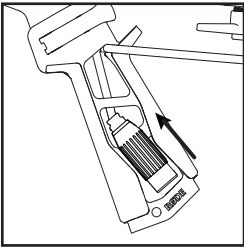

3. Remove the XLR cable from the handle by sliding upwards then through the handle as necessary to release the cable.

Fitting a cable

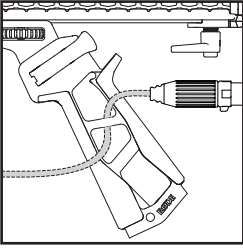

1. Insert the cable through the handle assembly so that the cable is routed as shown

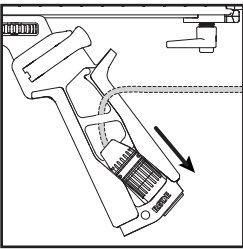

2. Insert the Male XLR end into the base of the handle as shown, with the end slightly protruding

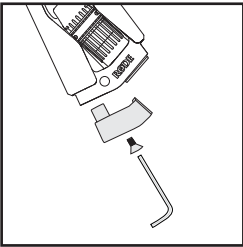

3. Secure the XLR cable in place using the XLR/Boompole Adapter, tightening the screw using a 3mm hex key.

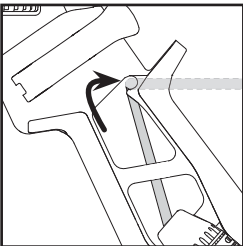

4. Secure the cable using the cable management clip at the top of the handle.

Fitting a cable

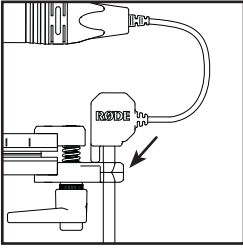

5. If using the Blimp Pro Cable, secure the cable in place using the cable grommet at the rear of the rails, ensuring that the orientation matches the image shown.

If using a cable other than the one supplied with your Blimp, simply secure it in place using the cable grommet, ensuring there is enough room for correct fitment of the rear dome.

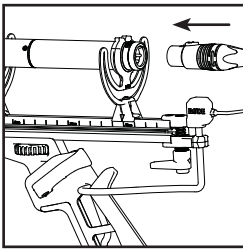

6. Connect the cable to the microphone and adjust the handle to the desired angle for use.

Using the 'Dead Wombat'

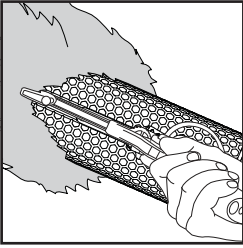

1. Insert the Blimp head-first, taking care to align the seam on the dead wombat with the rail on the underside of the Blimp.

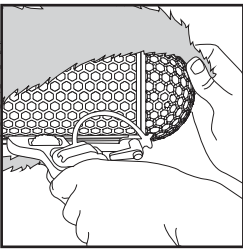

2. Loosen the drawstring on the dead wombat and carefully stretch the dead wombat over the rear dome.

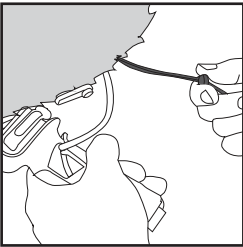

3. Straighten the dead wombat, then tighten and lock the drawstring.

It is recommended that you hook the drawstring over the front rail clamping lever to prevent any handling noise.



4. Brush the dead wombat from front to back to lift the hair and prevent matting.

This greatly assists in wind noise protection as well as extends the life of the dead wombat.

Laundering Instructions for Dead Wombat

We recommend that the DeadWombat be dry cleaned, however it can be hand washed in mild soapy water, rinsed well and air dried.

Once dry, thoroughly comb the synthetic fur to remove any knots and maximise product life.



RØDE[®]
MICROPHONES



Australia

107 Carnarvon st, Silverwater NSW 2128 Australia
Ph: +61 2 9648 5855 Fx: +61 2 9648 2455

USA

PO Box 4189, Santa Barbara CA 93140 USA
Ph: +1 805 566 7777 Fx: +1 805 566 0071