

Operation Manual

Digital Power Amplifier **DPA-150Q**



* Rack mount products in the Western Hemisphere(North America, South America, and the Caribbean) do not have handles installed due to customer preference.

interM

Welcome

A personal welcome to you from the management and employees of Inter-M

All of the co-workers here at Inter-M are dedicated to providing excellent products with inherently good value, and we are delighted you have purchased one of our products.

We sincerely trust this product will provide years of satisfactory service, but if anything is not to your complete satisfaction, we will endeavor to make things right.

Welcome to Inter-M, and thank you for becoming part of our worldwide extended family!

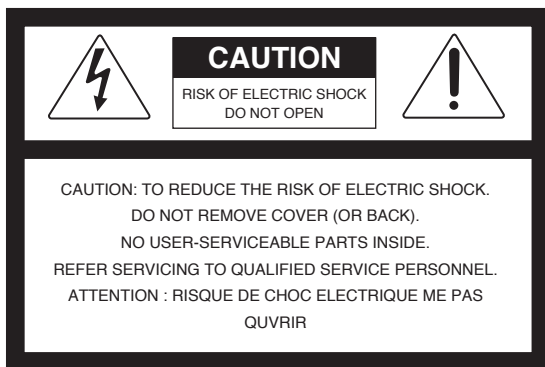

This symbol is intended to alert the user to the presence of uninsulated "dangerous voltage" within the product's enclosure that may be of sufficient magnitude to constitute a risk of electric shock to persons.



This symbol is intended to alert the user to the presence of important operation and maintenance (servicing) instructions in the literature accompanying the appliance.

Caution: To prevent electric shock do not use this (polarized) plug with an extension cord, receptacle or other outlet unless the blades can be fully inserted to prevent blade exposure.

Attentions: Pour prévenir les chocs électriques ne pas utiliser cette fiche polarisée avec un prolongateur, une prise de courant ou une autre sortie de courant, sauf si les lames peuvent être insérées à fond sans en laisser aucune partie à découvert.
Pour déconnecter complètement l'appareil du réseau d'alimentation. déconnecter le cordon d'alimentation de la prise murale.
La prise du réseau d'alimentation doit demeurer aisément accessible.

WARNING

To prevent fire or shock hazard, do not expose the unit to rain or moisture.

*WARNING FOR YOUR PROTECTION PLEASE READ THE FOLLOWING-WATER AND MOISTURE: Unit should not be used near water(e.g. near a bathtub, washbowl, kitchen sink, laundry tub, in a wet basement, or near a swimming pool, etc). Care should be taken so than objects do not fall and liquids are not spilled into the enclosure through openings.

*Do not install this equipment in a confined space such as a book case or similar unit.

*This apparatus shall not be exposed to dripping or splashing and no objects filled with liquids, such vases, shall be placed on the apparatus.

*This apparatus shall be connected to a mains socket outlet with a protective earthing connection.

*It has heed to be easy to disconnect the device. To disconnect the device from power, separate AC input cable from inlet or unplug the AC Cord.

CAUTION

*These servicing instructions are for use by qualified service personnel only. To reduce the risk of electric shock, do not perform any servicing other than that contained in the operating instructions unless you are qualified to do so.

NOTE

*This equipment has been tested and found to comply with the limits for a Class A digital device, pursuant to Part 15 of the FCC Rules. These limits are designed to provide reasonable protection against harmful interference when the equipment is operated in a commercial environment. This equipment generates, uses, and can radiate radio frequency energy and, if not installed and used in accordance with the instruction manual, may cause harmful interference to radio communications. Operation of this equipment in a residential area is likely to cause harmful interference in which case the user will be required to correct the interference at his own expense.

Contents

Unpacking	2
Installation	
Environment.....	2
Important Safety Instructions.....	2
Features	3
Contents and Accessories	3
Front Panel	4
Rear Panel	6
Applications	9
Block Diagram	10
Specifications	11
Service	
Procedures.....	13
Schematic.....	13
Parts List	13
Variations and Options	13
Warranty	13

Unpacking

Although your DPA-150Q is neither complicated nor difficult to operate, we recommend you take a few minutes to read this brief manual and familiarize yourself with the important information regarding product features, setup and operation.

As with most electronic devices, we strongly recommend you retain the original packaging. In the unlikely event the product must be returned for servicing, the original packaging (or reasonable equivalent) is required.

Installation

Environment

Never place this product in an environment which could alter its performance or reduce its service life. Such environments usually include high levels of heat, dust, moisture, and vibration.

IMPORTANT SAFETY INSTRUCTIONS

1. Read these instructions.
2. Keep these instructions.
3. Heed all warnings.
4. Follow all instructions.
5. Do not use this apparatus near water.
6. Clean only with dry cloth.
7. Do not block any ventilation openings. Install in accordance with the manufacturer's instructions.
8. Do not install near any heat sources such as radiators, heat registers, stoves, or other apparatus (including amplifiers) that produce heat.
9. Do not defeat the safety purpose of the polarized or grounding-type plug. A polarized plug has two blades with one wider than the other. A grounding type plug has two blades and a third grounding prong. The wide blade or the third prong are provided for your safety. If the provided plug does not fit into your outlet, consult an electrician for replacement of the obsolete outlet.
10. Protect the power cord from being walked on or pinched particularly at plugs, convenience receptacles, and the point where they exit from the apparatus.
11. Only use attachments/accessories specified by the manufacturer.
12. Use only with the cart, stand, tripod, bracket, or table specified by the manufacturer, or sold with the apparatus. When a cart is used, use caution when moving the cart/apparatus combination to avoid injury from tip-over.
13. Unplug this apparatus during lightning storms or when unused for long periods of time.
14. Refer all servicing to qualified service personnel. Servicing is required when the apparatus has been damaged in any way, such as power-supply cord or plug is damaged, liquid has been spilled or objects have fallen into the apparatus, the apparatus has been exposed to rain or moisture, does not operate normally, or has been dropped.



Features

- **HIGH-POWER, HIGH PERFORMANCE 4 CHANNEL CLASS-D POWER AMPLIFIER**
High-Power, high performance Class-D Professional Amplifier has up to 600W 4CH (150W×4) power output.
- **EMERGENCY POWER BACK UP (DC 24V) CAPABILITY**
The unit operates on a DC 24V battery power supply for emergency back up without UPS.
- **SMPS (SWITCHING MODE POWER SUPPLY) POWER SCHEME**
High efficient, light weight SMPS power system is utilized.
- **RATED OUTPUT POWER VIA DC BACKUP SUPPLY**
Output power can be maintained as AC power when DC 24V power supplied.
- **POWERFUL AND DETAILED SOUND QUALITY**
High S/N ratio and Low THD reproduces powerful and detailed sound.
- **COMPLETE PROTECTION CIRCUITS**
Complete circuit protection is activated in case of amplifier overheating, output shorting, overload, over power and DC output.
- **OPERATION INDICATOR LED**
LED display to check the operating status (AC, DC, STBY, POWER, SIG, -10dB, CLIP, PROTECT)
- **BALANCED INPUT**
This connection is used to ensure the lowest noise operation which eliminates the common noise from the cable.
- **REMOTE POWER ON/OFF**
The remote power allows the amplifier to be turned on or off from a distance or other device via dry contact closure.
- **PRIORITY INPUT**
PGM is interrupted and over ridden by the Priority input, when a contact closure is received on the Priority input terminal. This is Ideal for Emergency message broadcasting applications.

Contents and Accessories

1. Power Cord x 1
2. 6P Terminal Block x 2
3. 2P Terminal Block (Ac Remote power) x 1
4. 8P Terminal Block x 1
5. Screw for Rack Mount x 4
6. Washer x 4
7. Operation Manual x 1



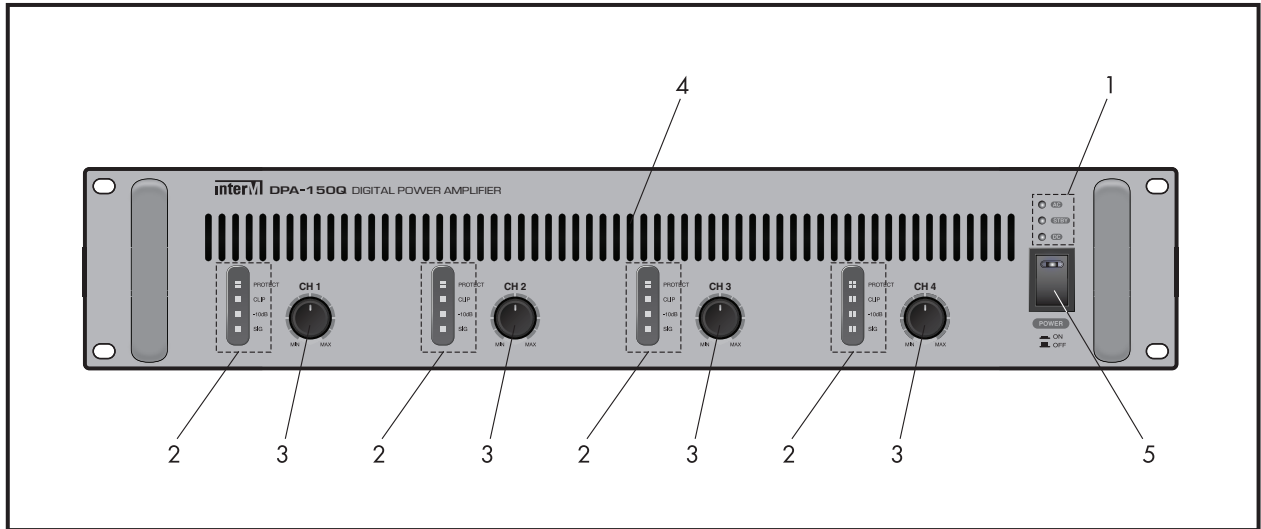





















Front Panel



1. AC, STBY, DC LED

When Power switch is on, AC or DC LED will illuminate depending on input Power source. When Power switch is off, STBY LED will turned on

※ NOTE: During operation of DC, amplifier is keep going to work even if the switch of power is turned off.

	Power SW	Power LED	AC LED	STBY LED	DC LED
AC/DC	SW ON	 ON	 ON	 OFF	 OFF
	SW OFF	 OFF	 OFF	 ON	 OFF
AC only	SW ON	 ON	 ON	 OFF	 OFF
	SW OFF	 OFF	 OFF	 ON	 OFF
DC only	SW ON	 ON	 OFF	 OFF	 ON
	SW OFF	 ON	 OFF	 OFF	 ON

2. OUTPUT LEVEL INDICATOR (1CH, 2CH, 3CH, 4CH)

Indicator display of unit's output level status.

SIG(-30dB) LED: Green, -10dB LED: Green, CLIP LED: Orange, PROTECT LED: Red

※ Note: If CLIP LED is lit, sound output is distorted. Reduce the volume level.

3. VOLUME CONTROL

Volume adjustments are made. Turn clockwise to increase the volume level.

4. FAN VENTS

The air circulation passage to prevent overheating of the device, please do not obstruct the flow as air flows from front to back.

5. POWER SWITCH

Push on/off switch. When Power switch is on, BLUE LED will illuminate.

Rear Panel

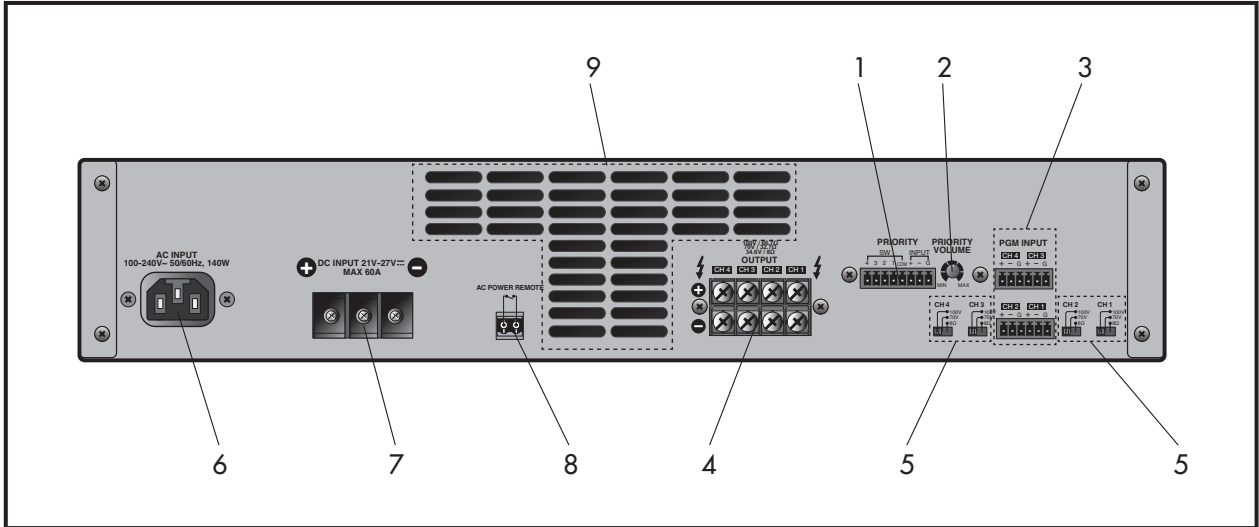

1. PRIORITY INPUT AND CONTACT CLOSURE

Each amplifier module has 2 audio inputs. The PGM input and PRIORITY input. PGM input is interrupted and over ridden by the PRIORITY input when a contact closure is received on the PRI select terminal. This is Ideal for Emergency message broadcasting applications. Please refer to the following picture about the suitable cables.

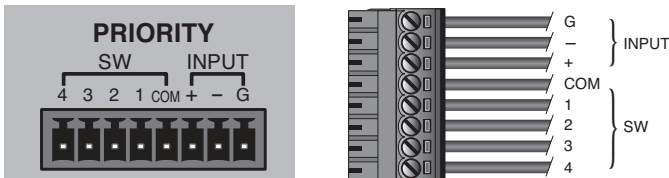

2. PRIORITY VOLUME CONTROL

It is a volume control of PRIORITY INPUT signal. This control can adjust PRIORITY INPUT signal used as emergency broadcasting. Turn clockwise to turn the signal level and counterclockwise to lower the signal level.

※ It is mainly for priority broadcasting so, don't make the VOLUME level too low.

3. PGM INPUT TERMINAL

Terminal block connector accepts the source input. Please refer to the following picture about the suitable cables.

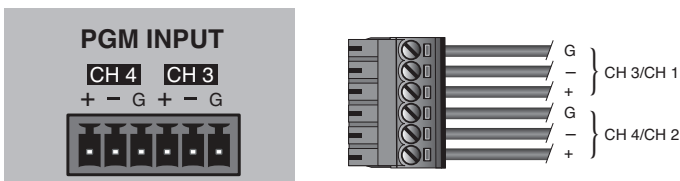

4. OUTPUT TERMINAL

Speaker Output Terminal. Before connecting speakers to the unit, be sure to disconnect the AC power cable. Make certain that the total impedance is not less than the rated impedance indicated.

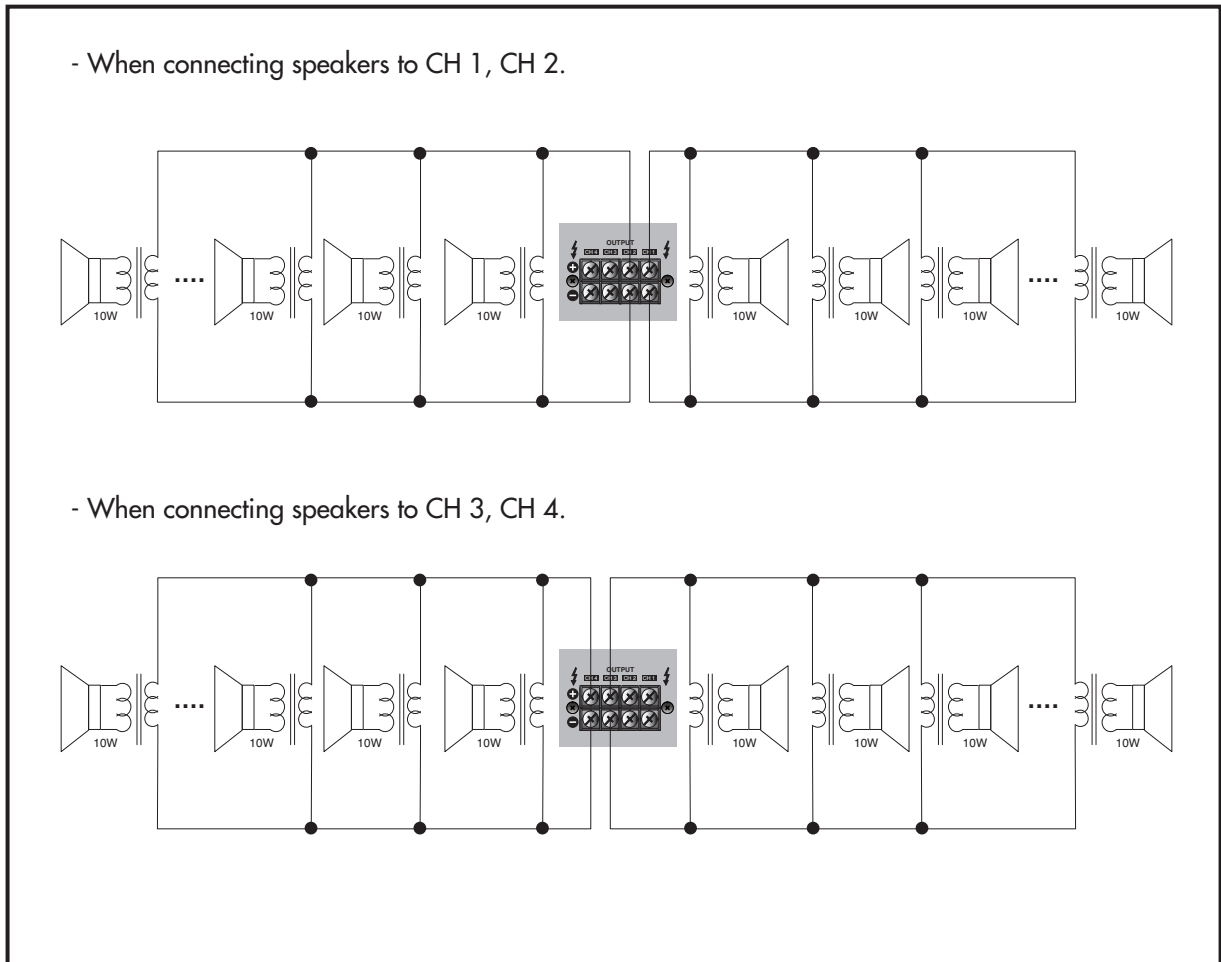

※ Caution: 1. Make sure that the total impedance does not equal or less than the rated impedance.

Speaker Output	Speaker Impedance
150W × 4	100V / 66.7Ω
	70V / 32.7Ω
	34.6V / 8Ω

2. Do not connect a speaker with lower impedance than rated impedance, it may cause the problem to unit.
3. Do not put the speaker cable close to input signal cable.

5. OUTPUT VOLTAGE SELECTOR SWITCH

This three-position switch is used to select an output voltage (100V / 70V / 8Ω).

6. AC INLET

Connect the power cable which is supplied with the unit. Do not bend, pull, twist, heat and cut by force. It may cause electric shock.

7. DC TERMINAL

This is emergency DC terminal (DC 24V). When something happens to AC power, DC power automatically operates. Input provides power to the device regardless of power switch.

※ Please check voltage and +, - polarity.

8. AC POWER REMOTE TERMINAL

This terminal allows the amplifier to be turned on or off from a distance or other device.

9. FAN VENTS

Air flow is front to back.

※ Caution: DO NOT block front or rear air vents.

Applications

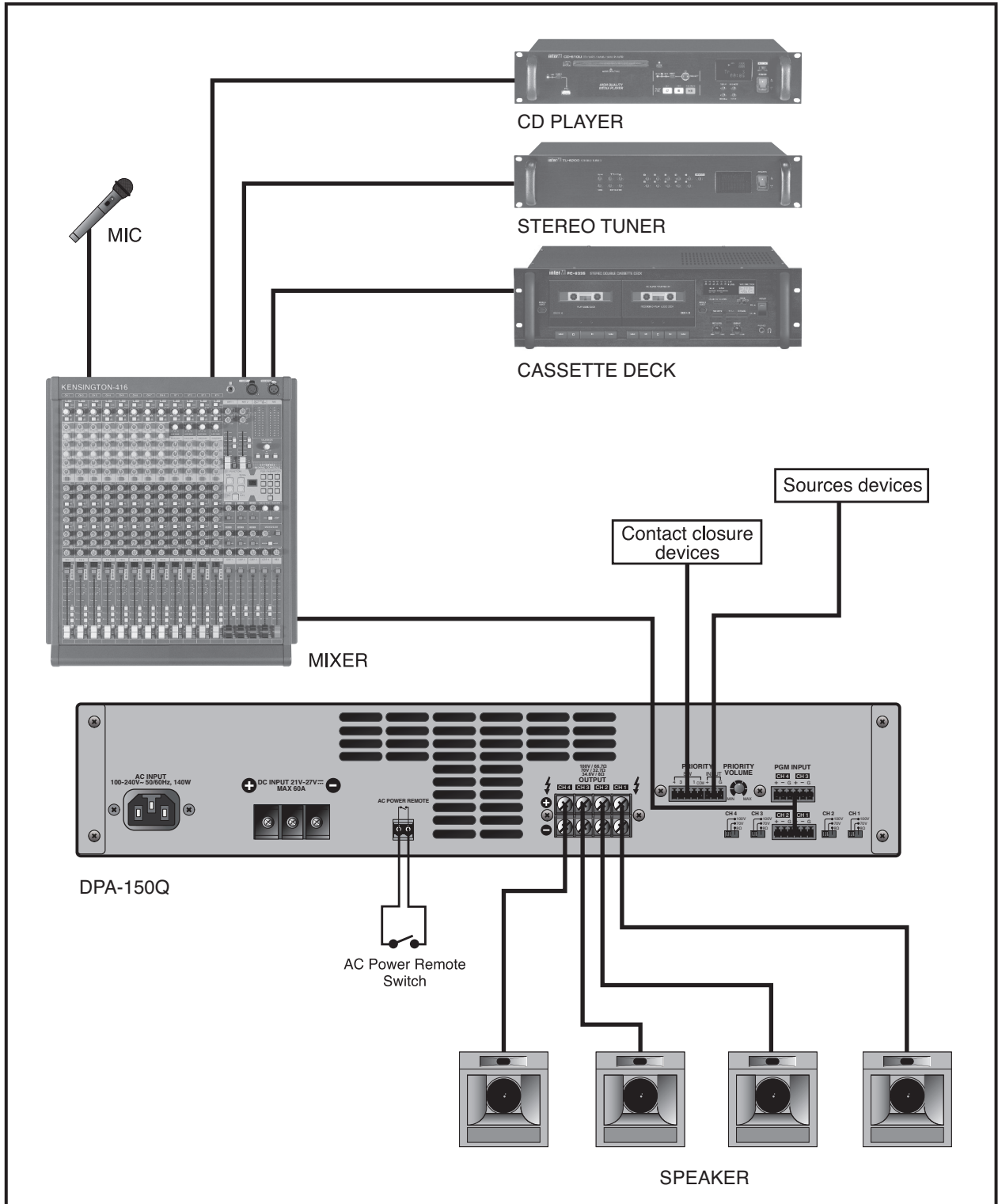

Block Diagram

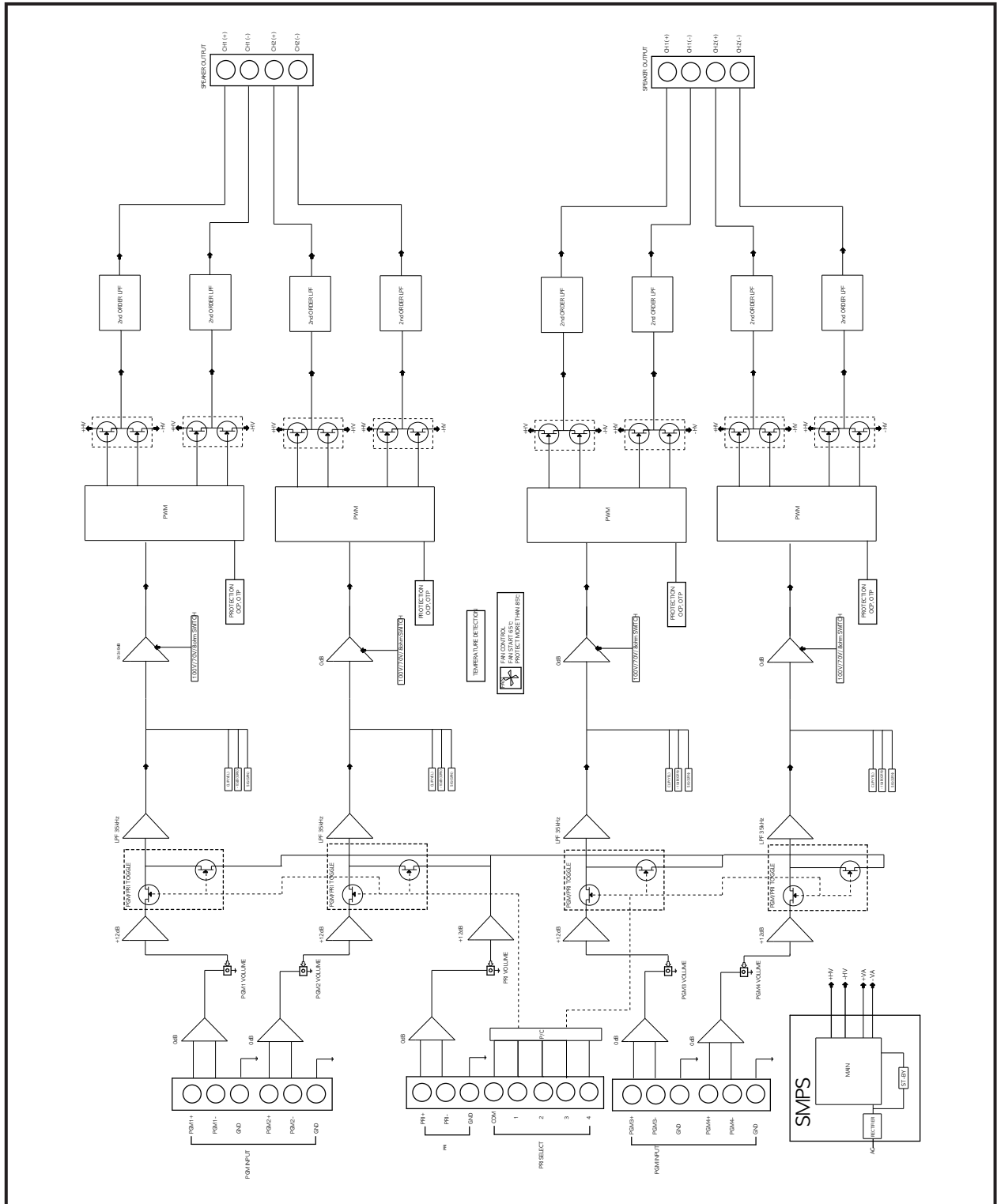

Specifications

	DPA-150Q
Rated Output Power	150W × 4
Peak Power	180W/CH
Output Level/Impedance	100V/66.7Ω
	70V/32.7Ω
	34.6V/8Ω
Input Sensitivity	1V/10kΩ
THD (AES17, 1/8 Power)	Less than 0.2%
S/N (20kHz LPF)	Better than 100dB
Frequency Response (1W, ±3dB)	50Hz~20kHz
Operating Temperature	-10°C ~ 40°C
Power Source	AC 100-240V, 50/60Hz, DC 24V
Power Consumption	140W
Weight (Set)	6.82kg/15.04lb
Dimensions (Set)	482(W) × 88(H) × 367(D)mm/18.98(W) × 3.46(H) × 14.45(D)in

* Design and specification are subject to be changed for the improvement of product quality without pre notice.

※ DIMENSIONS

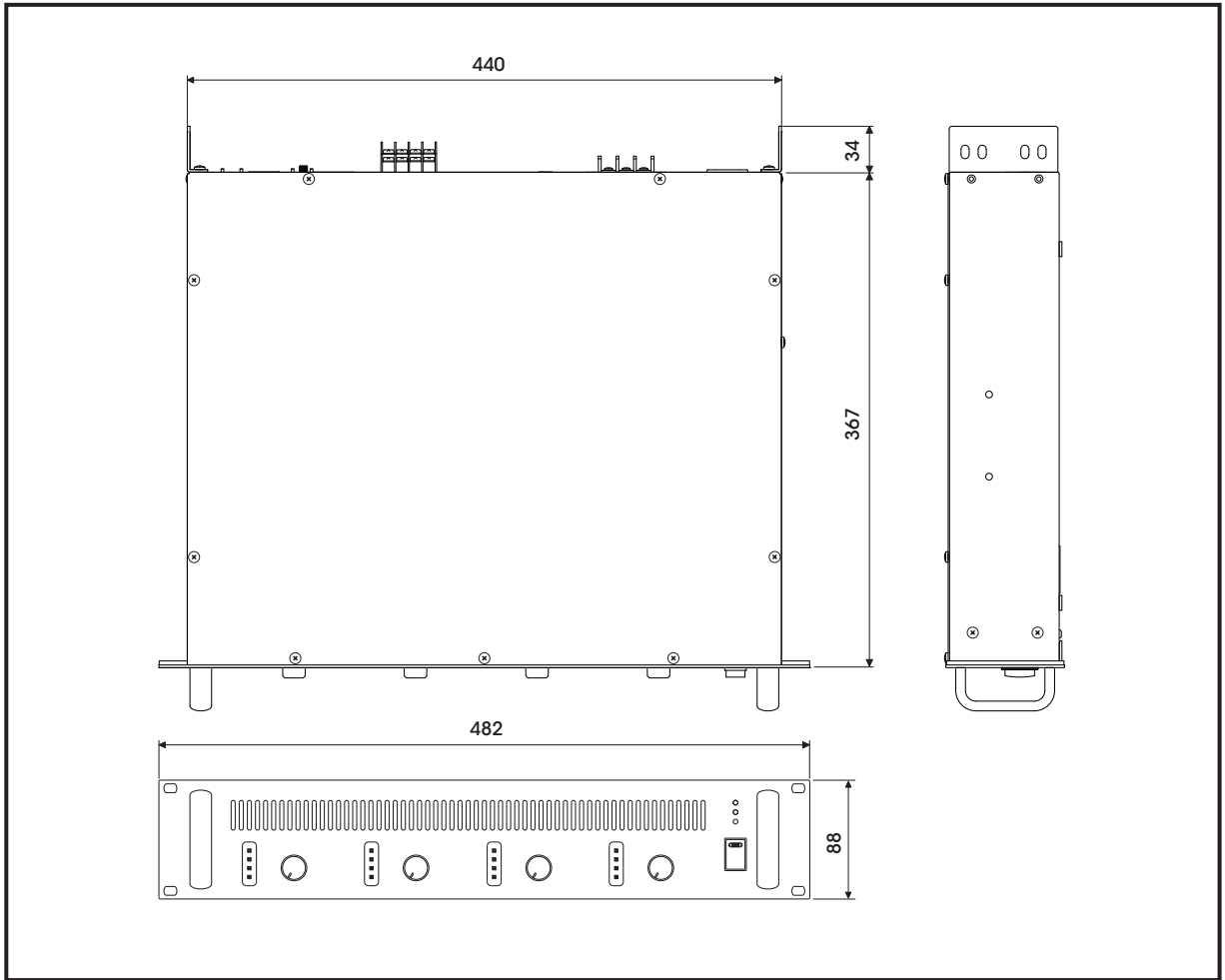

Service

Procedures

Take steps to insure the problem is not related to operator error or other products within the system. Information provided in the troubleshooting portion of this manual may help with this process. Once it is certain that the problem is related to the product contact your warranty provider as described in the warranty section of this manual.

Schematic

A Schematic is available by contacting your warranty provider.

Parts List

A Parts List is available by contacting your warranty provider.

Variations and Options

Variations

Products supplied through legitimate sources are compatible with local AC power requirements.

Options

No optional items are available for this product.

Warranty

Warranty terms and conditions vary by country and may not be the same for all products. Terms and conditions of warranty for a given product may be determined first by locating the appropriate country which the product was purchased in, then by locating the product type.

To obtain specific warranty information and available service locations contact Inter-M directly or the authorized Inter-M Distributor for your specific country or region.

interM