



Glensound
Keeps Working

GTM

eSports interface

PRODUCT DETAILS



GlenSound Electronics Ltd

Thank you for choosing a new GlenSound product.

All rights reserved.

Information contained in this manual is subject to change without notice, if in doubt please contact us for the latest product information.

If you need any help with your product then we can be contacted at:

GlenSound Electronics Ltd
1 – 6 Brooks Place
Maidstone
Kent
ME14 1HE
United Kingdom

Telephone: +44 (0) 1622 753662

Fax: +44 (0) 1622 762330

EMAIL ADDRESSES

General and Technical enquires: office@glenSound.com

Sales enquires: sales@glenSound.com

IMPORTANT SAFETY INSTRUCTIONS

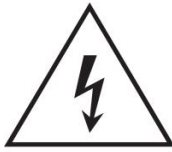

This symbol is intended to warn that dangerous voltages within the product are present and constitute a risk of electric shock.



This symbol is intended to highlight that there are important operating & maintenance instructions in the literature accompanying this unit.

- 1) Read these instructions
- 2) Keep these instructions
- 3) Heed all warnings
- 4) Follow all instructions
- 5) Do not use this apparatus near water
- 6) Clean only with a dry cloth
- 7) Do not block any ventilation openings. Install in accordance with manufacturer's instructions
- 8) Do not install near any heat sources such as radiators, heat registers, stoves, or other apparatus (including amplifiers) that produce heat
- 9) Do not defeat the safety purpose of the polarized or grounding type plug. A polarized plug has 2 blades with one wider than the other. A grounding type plug has 2 blades and third grounding prong. The wider blade or the 3rd prong are provided for your safety. If the provided plug does not fit into your outlet, consult an electrician for replacement of the obsolete outlet
- 10) Protect the power cord from being walked on or pinched, particularly at plugs, convenience receptacles and the point where they exit from the apparatus
- 11) Only use attachments/ accessories specified/ supplied by the manufacturer
- 12) Use only with the cart, stand, tripod, bracket, or table specified by the manufacturer, or sold with the apparatus. When a cart is used, use caution when moving the cart/ apparatus combination to avoid injury from tip over
- 13) Unplug this apparatus during lightning storms or when unused for long periods of time
- 14) Refer all servicing to qualified service personnel. Servicing is required when the apparatus has been damaged in any way, such as power supply cord or plug is damaged, liquid has been spilled or objects have fallen into the apparatus, the apparatus has been exposed to rain or moisture, does not operate normally, or has been dropped
- 15) Do not attempt to modify this product. Doing so could result in personal injury and/ or product failure

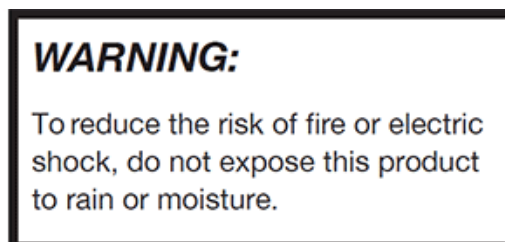
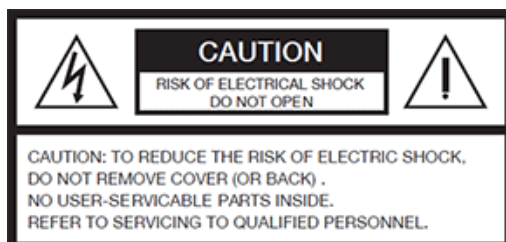

PRODUCT WARRANTY

All equipment is fully tested before dispatch and carefully designed to provide you with trouble free use for many years.

We have a policy of supporting products for as long as possible and guarantee to be able to support your product for a minimum of 10 years.

For a period of one year after the goods have been despatched the Company will guarantee the goods against any defect developing after proper use providing such defects arise solely from faulty materials or workmanship and that the Customer shall return the goods to the Company's works or their local dealer.

All non-wear parts are guaranteed for 2 years after despatch and any defect developing after proper use from faulty materials or workmanship will be repaired under this warranty providing the Customer returns the goods to the Company's works or their local dealer.



EU DECLARATION OF CONFORMITY

GTM

eSports interface

This declaration of conformity is issued under the sole responsibility of the manufacturer.

This equipment is manufactured by Glensound Electronics Ltd of Brooks Place Maidstone Kent ME14 1HE is  marked and conforms to the following Union harmonisation legislation:

Emissions:	BS EN55032:2015
Immunity:	BS EN55035:2017

Signed for and on behalf of Glensound Electronics Ltd.



Marc Wilson, Managing Director
Maidstone, Kent, England

Date: 25/08/2022

RoHS DIRECTIVE

RoHS 2 Directive 2011/65/EU restricts the use of the hazardous substances listed below in electrical and electronic equipment.

This product conforms to the above directive and for these purposes, the maximum concentration values of the restricted substances by weight in homogenous materials are:

Lead	0.1%
Mercury	0.1%
Hexavalent Chromium	0.1%
Polybrominated Biphenyls	0.1%
Polybrominated Diphenyl Ethers	0.1%
Cadmium	0.01%

WASTE ELECTRICAL AND ELECTRONIC EQUIPMENT REGULATIONS 2006 (WEEE)

GlenSound Electronics Ltd is registered for business to business sales of WEEE in the UK our registration number is:

WEE/JJ0074UR

Optional SDI Interface.....	21
De-embedding.....	21
Embedding.....	21
Connecting The GTM To A Dante Network.....	22
Getting Dante Controller	22
Connecting GTM device to the network	22
Audio Over IP Network	22
Running Dante Controller	23
Dante Controller TIP	23
Device not showing up in Dante Controller	24
AES67 Mode	25
Turning On AES67 Mode.....	25
Sending AES67 Audio	25
Receiving AES67 Audio.....	26
AES67 Restrictions	27
Glensound Controller.....	28
Installing the app	28
Sideloadng	28
Uninstalling the app	28
Using the app with the GTM.....	29
Saving and loading presets.....	32
Updating Firmware	33
Instructions.....	33
Updating The Dante firmware	35
Updating the device	35
GTM DC Loop I/O	37
Wiring Information.....	38
XLR & JACK Wiring	38
OPTIONAL 5 or 4 PIN XLR WIRING INFORMATION	39

Overview

The GTM combines the multiple functions required for the interfacing and communications in eSports tournaments into one simple to use device.

GTM provides the interface for the gamers, provides the intercom mix, and allows remote control by tournament engineers. There are separate modes that also mean the GTM can be used by the Coaches, Referees, and arena Announcers.

The GTM is also available in a stripped down version called the GTM SI, with no direct top panel controls, for system integrators.



GTM Top Panel Layout



Game Team Me encoders

GAME	The level of the game audio in the headphones.
TEAM	The level of the team mix audio in the headphones.
ME	The level of the user's own microphone (sidetone) in the headphones.

The GTM is flexible because the game encoder audio can be fed from multiple different input sources (Dante, Stereo Aux jack, TOSLINK, USB audio and optionally via de-embedding from SDI). Mixing and panning controls for game audio can be set in GlenController, see [this section](#) for more information.

The GTM has a customisable team comms mix over Dante where up to 6 other players can be brought into the unit and mixed together and listened to via the Team encoder. There are also extra inputs for coaches, referees or auxiliary audio channels. These channels are presented as Dante inputs, and the mix can be configured in GlenController, see [here](#) for more information.

The Me encoder adjusts the level of the selected mic input fed into the programme output for the headphones to provide a low latency path to hear your own voice which can be particularly useful in high noise environments.

The relative position of the encoders is represented by the light rings around them. Pushing the encoders down as a switch whilst pressing the rear panel Update button allows stereo panning to be controlled for the respective channel audio, in this mode the led rings will display the stereo field position until a few seconds after the last user adjustment, where it then reverts to volume mode.

Me button

This is the speak button. Pressing the button sends the microphone audio to Dante channel 1. It illuminates red to indicate that the microphone is live. In GlenController It can be configured to have 6 different behaviours:

Mode	Description (The default behaviour is 'Intelligent')
Intelligent	<i>A brief push of the key will turn the channel on or off. But a press and hold of the key will only turn the output on (or off if already on) while the key is being pressed.</i>
Momentary	<i>The key must be held down to operate.</i>
Latching	<i>A push of the key will turn the channel on, another push will then turn the channel off.</i>
Cough	<i>The channel is always on and only off when the key is pressed and held down.</i>
Always on	<i>The key is always on and cannot be turned off.</i>
Always off	<i>The key is disabled and cannot be turned on.</i>

Talk button

This is a second talk circuit that is only used when the device is set to Coach or Referee mode, see [this section](#) for more information. Pressing the button sends the microphone audio to Dante channel 2.

Mic metering

This 5-point LED meter shows the users post gain mic level to allow for easy mic gain adjustment. The scale is in dBu. The meter is always on, even if the Me or Talk buttons are not active.

GTM Front Panel Layout



XLR Microphone input

This standard 3 pin XLR is the input of the user's microphone. +48V phantom power can be enabled or disabled for use with condenser microphones using rear panel controls or via GlenController. A compressor is available which can be toggle on or off in GlenController.

For use with different headsets, the GTM can be fitted at the factory with a female 5-pin XLR, male 4-pin XLR or standard female 3-pin XLR. The GTM can also be wired with the 2.5V/5V DC bias routed to this connector for use with single ended electret microphone headsets. See the end of the manual for wiring information.

Headphone output

The GTM headphone output can drive headphones with impedances between 16 and 1000 Ohms. It can accept mono jacks without causing and damage to the output circuits. There is a 6.35mm (1/4") stereo jack socket and 3.5mm stereo jack socket for convenience meaning no adapter is necessary.

For these two connectors, only one set of headphones may be used at the same time, therefore the 3.5mm output is disabled when headphones are connected to the 6.35mm output.

TRRS Headset

This 3.5mm 4-pole TRRS connector allows PC or Gaming headsets to be used with the GTM.

This connector is fed from a second independent microphone preamplifier channel and a second independent headphone output circuit.

A TRRS headset or just standard TRS headphones can be connected. This output can drive headphones with impedances between 16 and 1000 Ohms.

This connector provides a configurable DC bias voltage to power the electret microphones commonly found in PC and gaming headsets. The DC bias voltage can be set to either +2.5V or +5V using rear panel controls, or via GlenController. As standard this connector is wired for the CTIA pinout, but OMTP may be available on request. See the end of the manual for wiring information.

This connector can be used in conjunction with the other headphone output to drive two sets of headphones at the same time. Refer to [this section](#) for more details.

GTM Rear Panel Layout



Mic selection & Mic gain control

Here the active Microphone input can be chosen between the XLR and TRRS headset inputs. Pressing and holding a button for a few seconds makes the panel live and changeable. Press either button once to switch the input. The chosen active input will light green and then the gain for that microphone can be adjust with the higher and lower buttons.

Pressing and holding the XLR mic selection button will enable or disable +48V phantom power (indicated by a red LED).

Pressing and holding the Headset mic selection button will toggle the TRRS mic DC bias voltage between +2.5V and +5V. Note that +2.5V is the default state and is recommended if your headset manufacture does not supply Mic bias voltage specifications.

Mic source selection, gain and DC power can be remotely controlled or locked in GlenController, see [this section](#) for more information.

Game source selection

This button allows quick selection of the GTM's Game input source. The source and mixing controls can be fully configured in GlenController, see [this section](#) for more information.

Identify/ Update button

Hold the button down when powering up the unit to enter DFU mode for manual firmware updating.

In normal operation pushing and holding this button at the same time as other buttons allows changing the device settings, see [this page](#) for more information.

Network RJ45 etherCON

Primary and Secondary 1Gbps ethernet IP interfaces allow connection to a Dante network. The GTM can operate in full redundant mode or in switched mode for daisy-chaining network devices. The LED indicates network activity. Both connectors are Neutrik etherCON which allow locking connections with a compatible etherCON cable.

The GTM has two internal PoE power supplies (one for each interface) to support full redundant power configurations. The PoE source used to power the device can be a mid-span adapter or a network switch with PoE conforming to IEEE 802.3af. The blue LED beneath each connector illuminates when PoE power is present.

USB C connector

This reversible USB C connector is used for USB audio and manual firmware updates.

The GTM supports bi-directional USB audio on PC and Mac and will appear as both a USB microphone and as USB stereo speakers.

The input can be selected via the game source selection button or on GlenController where panning and input level control is available.

The active microphone input audio is always on via USB (see block diagram for more information).

TOSLINK connector

This TOSLINK input connector allows routing an optical S/PDIF source to the Game encoder. The input can be selected via the game source selection button or on GlenController where panning and input level control is available.

Stereo Aux input

This 3.5mm 3-pole TRS input accepts typical consumer level analogue stereo aux sources. The input can be selected via the game source selection button or on GlenController where panning and input level control is available. See the end of the manual for wiring information.

This connector has an M6 x 0.5 outer thread for locking with Switchcraft jack plugs such as Switchcraft 35HDLBAU.

GPIO DC Loops

This is a 6-way 3.81mm pitch terminal block connector providing general purpose inputs and outputs (GPIO) for controlling certain actions. Please see [this section](#) for more information.

SDI interface (optional extra)

The GTM has an optional 3G-SDI interface for de-embedding and embedding audio from/to an SDI video feed with two 75 Ohm BNC connectors. A Lock LED (not pictured) indicates a valid SDI input signal is present. Please see [this section](#) for more information.

Audio Block Diagram

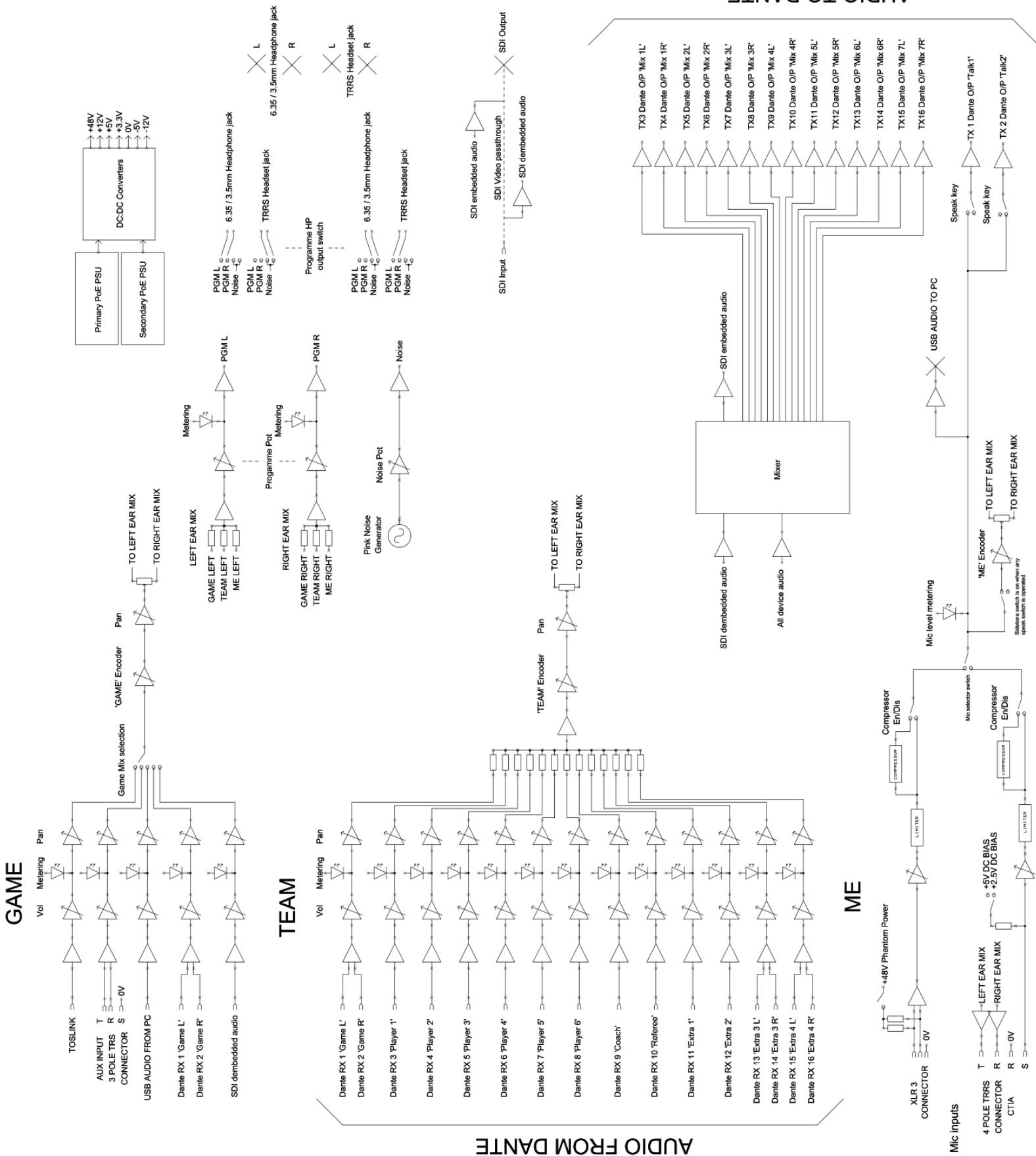

AUDIO TO DANTE

AUDIO FROM DANTE

USB Audio

The GTM supports bi-directional USB audio on PC and Mac and will appear as both a USB microphone and as USB stereo speakers.

We recommend setting the Windows volume control of the microphone to **62%** to ensure a 1-to-1 Mic gain level, any higher and windows will add artificial gain which is not optimal to achieve the best noise performance. Setting the volume to 62% ensures gain is achieved by using the GTM's on-board high-quality microphone preamplifier.

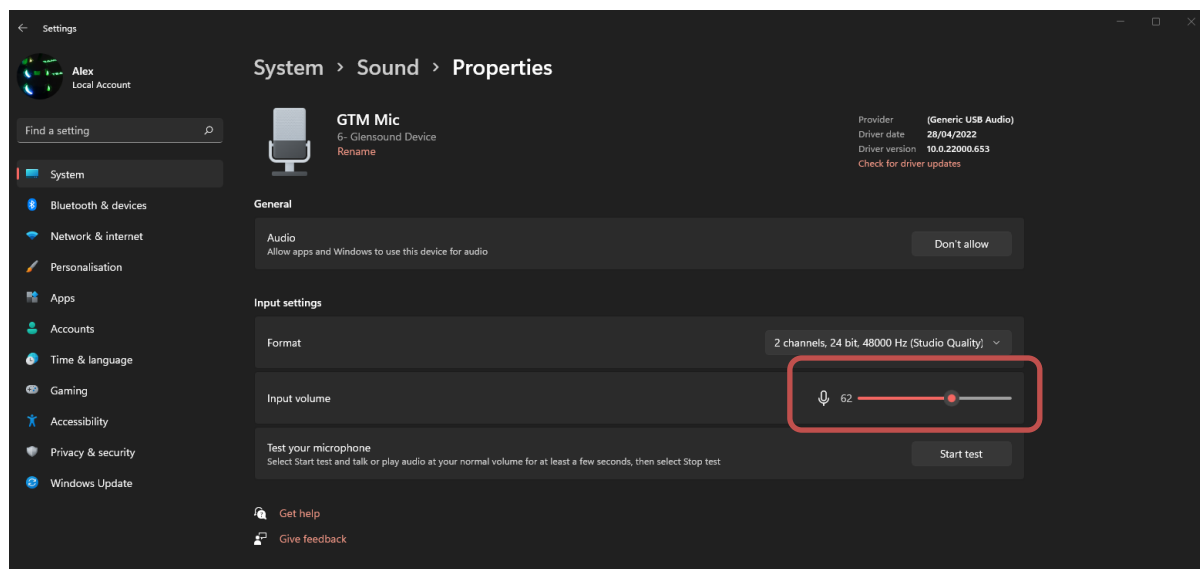

Setting the volume below 62% will artificially reduce the level of the microphone as heard in Windows, which may lead to undesired low mic level. If a quieter mic is required, then the user should either turn their microphone gain down on the unit or the receiving device who is listening to the mic should lower their incoming audio.

Setting the volume of Windows audio heard in the GTM headphones can be done via the Game encoder, or the game source control section of GlenController. The GTM will ignore the Windows volume output setting.

Device roles

The GTM has three different modes of operation: Player (default), Coach and Referee. The currently selected role is denoted by the GTM top panel led lighting:

Player	=	Green
Coach	=	Yellow
Referee	=	Magenta

As of GTM firmware version 0.2.12 the functionality of the device roles has yet to be implemented, but it is intended to provide methods of automatically controlling things such as audio routing, automatic white noise generation, attention indication and game phase management.

Currently the only difference between roles is Coach and Referee modes allow the use of the Talk button in addition to the Me button.

The GTM can also be assigned a unit ID via GlenController. This is intended to be used in future firmware updates to facilitate control automation and does not currently have any effect.

Additional features

Noise generator

The GTM has two independent headphone output circuits via the headphone jack and TRRS headset jack. The GTM also has a built-in white noise generator. This means that the GTM supports the use of IEMs and over ear headsets all in one device.

The white noise can be configured to be present on the disused interface i.e. Programme audio is output to the IEMs on the TRRS headset connector and white noise is fed to the over ear headphones on the standard TRS connector and vice versa. This allows for increased sound isolation when players wear both IEMs and over ear headphones at the same time.

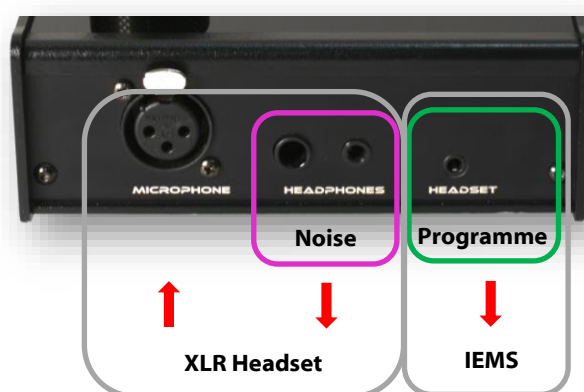

This has been designed specifically to combat eSporting arenas where players can sometimes hear the arena shoutcasting from the PA system.

A future software update will expand on this functionality and allow external triggering of noise generation alongside other features.

Hidden Features

The following controls are all configurable with GlenController.

Update button key combinations:

Update + Mic Gain Up + Mic Gain Down	- Factory reset
Update + Game encoder switch	- Role select
Update + rotate a knob	- Pan function

Factory reset

It restores the unit settings to the factory defaults and clears the remote access password.

- Press and hold Update, Up and Down (gain setting) buttons for more than 5 seconds.
- The Nominal (gain) LED starts blinking.
- The factory settings are restored when any of the held buttons is released.

Selecting a Role

- Press and hold the Update button and Game encoder switch together for more than 5 seconds.
- The top panel LEDs will show the current role as follows:

** The GTM logo colour is: green = Player, yellow = Coach, magenta = Referee*

** The knob LED bar and the label for the selected role are blinking: Me = Player, Team = Coach, Game = Referee.*

** The other knob LED bar and labels are off.*

- To change role press a knob's encoder switch. The corresponding LED bar and label will blink and the logo will change colour.
- To confirm, press the Update button. To cancel, wait for 5 seconds and the unit will revert to normal mode.
- The top panel will be lit according to the role's colour theme.

Optional SDI Interface

The GTM supports de-embedding and embedding audio from/to an SDI video feed.

The GTM can support speeds of 2.970Gb/s, 2.970/1.001Gb/s, 1.485Gb/s, 1.485/1.001Gb/s, and 270Mb/s and is compliant to SMPTE ST 425 (Level A and Level B), SMPTE ST 424, SMPTE 292 and SMPTE ST 259-C.

The SDI input supports typical equalized length of Belden 1694A cable up to:

- 200m at 2.97Gb/s
- 280m at 1.485Gb/s
- 500m at 270Mb/s

With the SDI output capable of typically driving at least 800mV at 75Ohms.

De-embedding

The GTM can de-embed the first 2 channels of an SDI video stream (Group 1 pair 1 L & R).

These two channels are presented as a stereo Game source input and can be used to feed game audio to the game encoder.

Mix and panning controls are available in GlenController, see [this section](#) for more details.

Embedding

In accordance with SMPTE ST 272 and SMPTE ST 299, the GTM can embed 4 channels of audio at 48kHz.

The 4 embedded channels are:

- Group 1 pair 1 L = Talk 1 Mic
- Group 1 pair 1 R = Summed Team mix
- Group 1 pair 2 L = Game L mix pre-panel encoder
- Group 1 pair 2 R = Game R mix pre-panel encoder

Note: A valid SDI video input signal must be present on the Input BNC connector for the GTM to be able to embed audio to an outgoing SDI video feed.

Connecting The GTM To A Dante Network

The GTM is a network audio device utilizing the reliable and versatile Dante audio over IP protocol. Dante is a proprietary system (although very widely used) the originators of which are Audinate.

The information below is only meant as a very basic guide. Full details of the power of Dante network audio and instructions for using it can be found at www.audinate.com

Getting Dante Controller

If you are connecting the GTM to a new Dante network the first thing you will need to do is to get the free Dante controller software from Audinate.

This can be downloaded by visiting Audinate's web site at www.audinate.com

Connecting GTM device to the network

The GTM can be connected to the network that you are going to use for your audio distribution simply by plugging in to the RJ45 network connections on the rear. Once connected to the network it will be possible to see the GTM from within the Dante controller and route its' audio circuits.

Audio Over IP Network

We strongly recommend that you consider your network topology carefully and would not recommend sharing broadcast audio and general data on the same network.

For more details of audio over IP network structure please visit www.audinate.com

Running Dante Controller

At the time of writing this manual the Dante Controller looks as per the screenshot below:

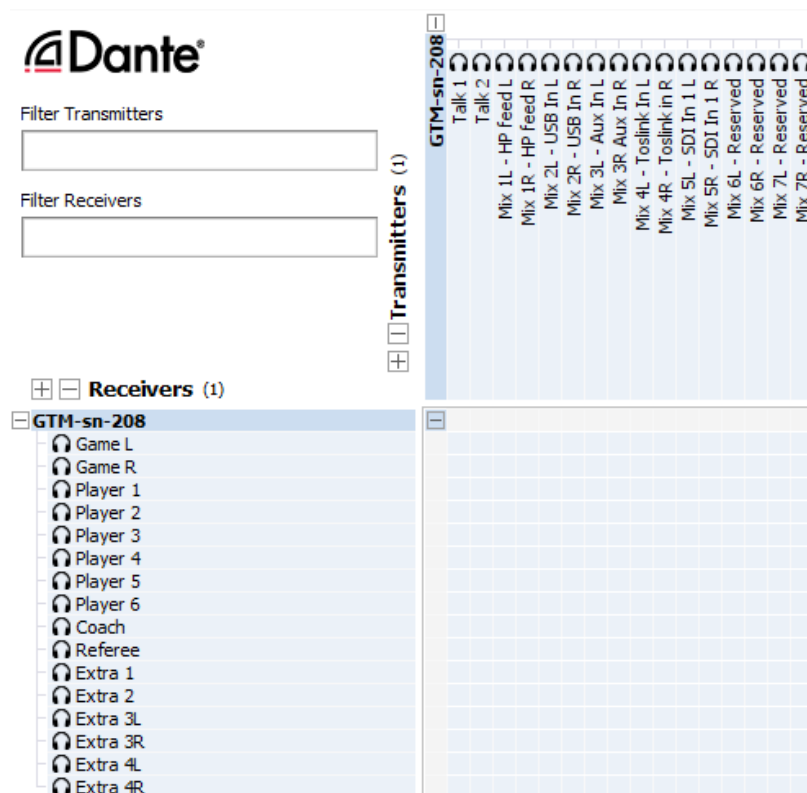

The GTM will have been named at the factory during test to allow them to be identified by the Dante controller.

The format used for the factory name is:

'GTM-SN-XXXX'

Where 'GTM' refers to the Glensound product i.e. GTM

The 'SN-XXXX' refers to the serial number of the GTM which can be found printed on the rear or side of the unit.

The unit may be renamed in Dante controller by opening the 'Device view' window and selecting GTM in the drop-down menu. Go to the 'Device Config' tab and change the name with the Rename Device box.

Note if you upload a new DNT file or clear the devices config then the name will change to 'GTM-xxXxXx' whereby the 'X's refer to the devices MAC address.

Dante Controller TIP

If you have never run Dante controller before then make sure that on the bottom left of the Dante controllers' screen 'P' or 'S' is next to a green square as this indicates that it is connected to a network. By clicking 'P' or 'S' a pop up box opens to allow you to set what network interface the controller is using.

Device not showing up in Dante Controller

If your Dante device does not show up in Dante Controller then the most likely issue is that the device's IP Address is not appropriate for your network.

- A) It maybe that the device is set to obtain an IP address automatically using DHCP (this is the default configuration) and your network is setup for fixed IP addresses only and does not have a DHCP server.
- B) It maybe that the device has had a fixed IP address assigned but that this address is not suitable for your network.

The solution to both scenarios is basically the same.

- 1) You must connect your Dante device directly to the Ethernet port of your computer using an Ethernet cable.
- 2) Make sure that your computer is set to 'Obtain an IP address automatically'
- 3) After a few minutes the Dante device should now appear in Dante Controller.
- 4) Double click the device name to open up device view.
- 5) Open up the 'Network Config' tab
- 6) Either turn on 'Obtain an IP Address Automatically' or correctly configure the 'Manually configure an IP Address' options for your network.
- 7) Click on 'Apply' to confirm the new settings, then disconnect the computer and reconnect the Dante device to your network.

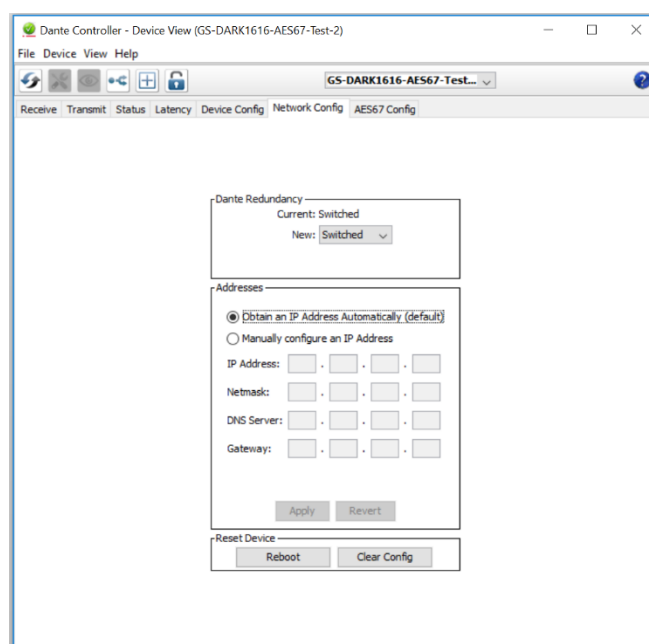

AES67 Mode

The GTM uses a chipset from Audinate called the Broadway for its network audio interface. Audinate are the company behind Dante and as such the primary network audio protocol is Dante, however Audinate have enabled their chip to comply with AES67 and therefore the GTM can be set to AES67 mode for interaction with other AES67 devices.

Please note however that Glensound are relying on Audinate's AES67 interface and are unfortunately not able to provide full AES67 support for the unit. AES67 support should be sought directly from Audinate.

Turning On AES67 Mode

If you want to use your GTM on an AES67 network and it has not been set to AES67 mode then this can be set in Dante controller by double clicking the GTM to open the Device View window where you will find an AES67 tab to enable AES67 support.

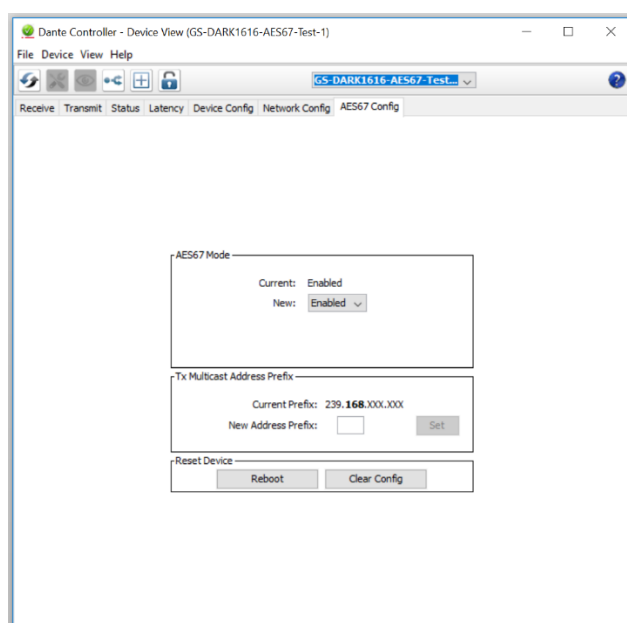

Once the AES67 drop down box has been enabled you'll have to reboot the GTM for the change to take effect. After the reboot go back to the AES67 tab and set the multicast prefix address to one that is suitable for your network.

Sending AES67 Audio

To transmit AES67 audio to the network a multicast flow must first be setup.

This is done by selecting the 'Create New Multicast Flow' icon  in the Device View.

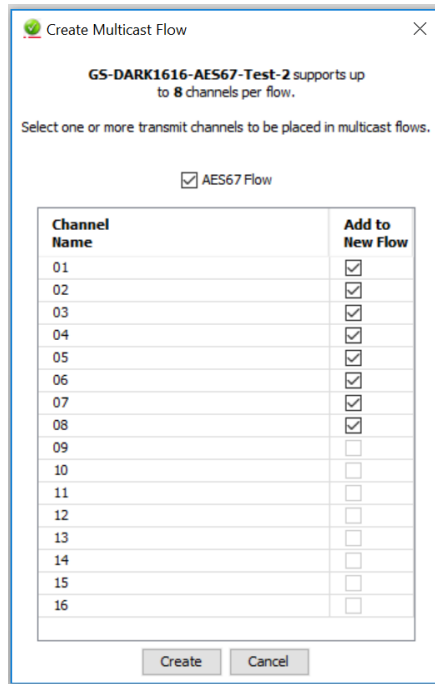

Tick the AES67 Flow check box, then select channels to be included in the flow then click 'Create'

Once set the flows can be seen in the transmit tab of the device view.

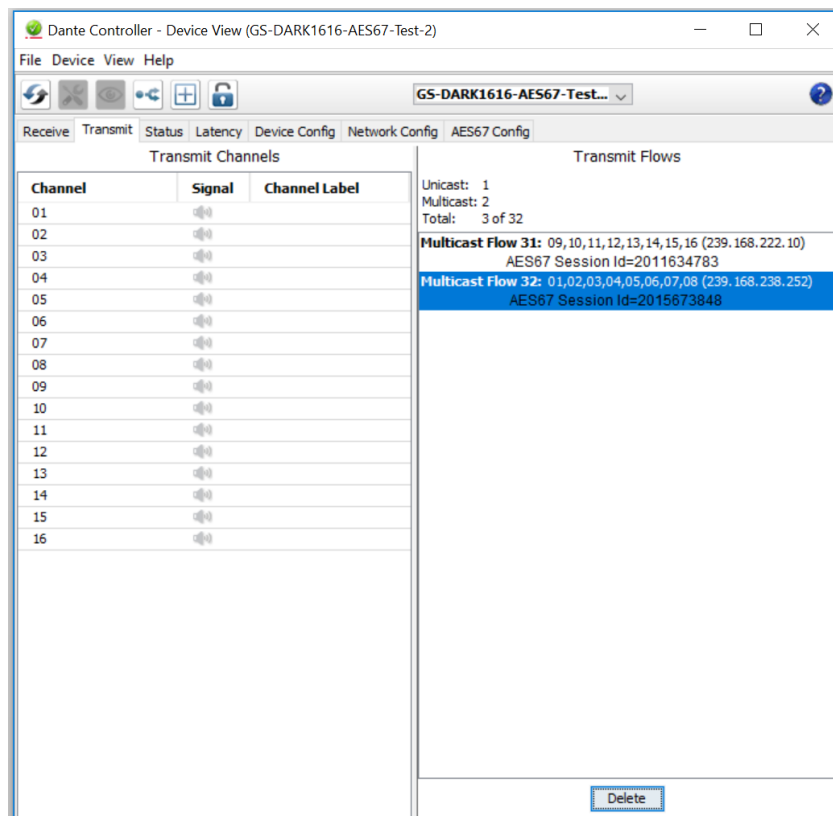

Receiving AES67 Audio

Once a compatible AES67 stream is detected on the network by Dante Controller the AES67 flows will appear in the Dante Transmitters section in the Routing tab.

AES67 Restrictions

AES67 flows can only be generated with the following constraints:

- Multicast Only
- Non-redundant
- Destination address in range 239.nnn.0.0 to 239.nnn.255.255 (239.nnn/16), port 5004
- 48kHz sampling rate
- 24 bit linear (L24) encoding
- 1 msec packet time
- Up to 8 channels per stream

Received AES67 flows have the following constraints:

- Multicast Only
- Non-redundant
- Destination address in range 239.nnn.0.0 to 239.nnn.255.255 (239.nnn/16), port 5004. Must match destination address range.
- 48kHz sampling rate
- L16 or L24 encoding
- 125usec, 250usec, 333usec, 1 msec packet time
- Up to 8 channels per stream

The GTM also supports SMPTE-ST2110-30 via Dante Domain Manager (DDM), with a license purchased from Audinate.

GlenSound Controller

GlenSound Controller is a windows 10 & 11 application that allows remote control of some GlenSound products over a network. The GTM has full remote-control functionality and can be operated from a remote location with only a windows PC and access to the network the GTM is on.

Installing the app

1. To install the latest version of GlenSound Controller go to the 'Download' tab at <https://www.glenSound.co.uk/product-details/glencontroller/> and click on the highlighted orange text "Install GlenSound Controller".

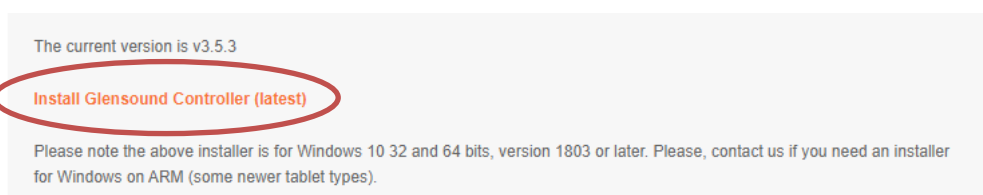

2. Next click "Open App Installer" if prompted.

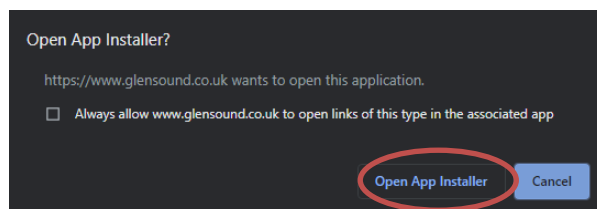

3. Then simply click "Install"

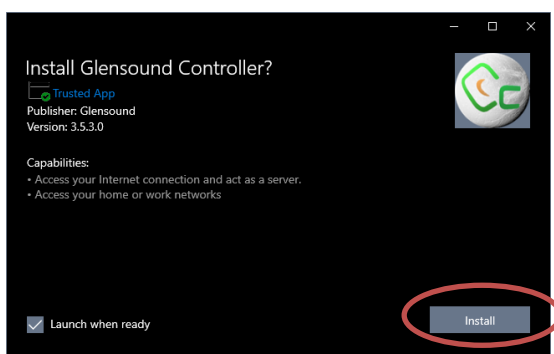

4. The app will install and open when ready

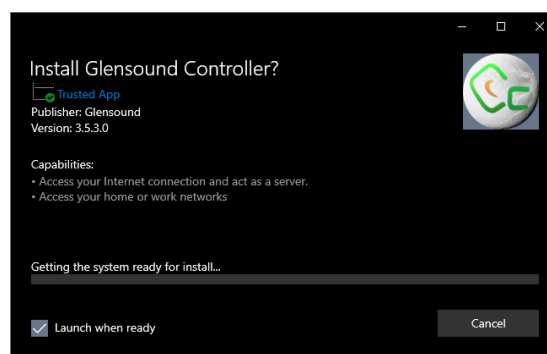

Sideloading

Some windows machines may be required to enable 'sideloading' of programs if it has been disabled by your organization. To enable, go to → **Windows Start** → **Settings** → **Update and Security** → **For developers** → Select '**Sideload apps**'.

Uninstalling the app

To uninstall GlenSound Controller open the windows start menu and find GlenSound Controller, right click and choose "Uninstall".

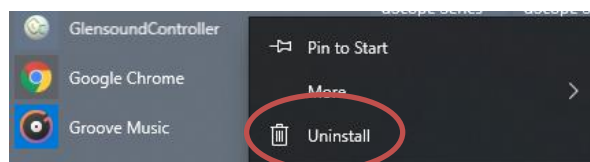

Using the app with the GTM

Main view

Game mix settings
 Team mix settings
 Talk settings
 Game mix meter
 Team mix meter
 Speak keys
 Mic activity metering

Mic input source selection
 Mic gain control
 Phantom power +48V toggle and 2.5V/5V DC bias toggle (when headset source selected)
 Mic compressor toggle
 Disable mic selection switch on the unit
 Disable phantom power switch on the unit

HP output settings
 Programme output to headphones meter
 Game, Team, Me volume and stereo panning control
 Disable mic gain control on the unit

HP Settings view

Programme audio volume control
 Noise generator volume control – present on non-programme output
 Programme output selector. Noise generator will be present on non-selected output

Talk Settings view

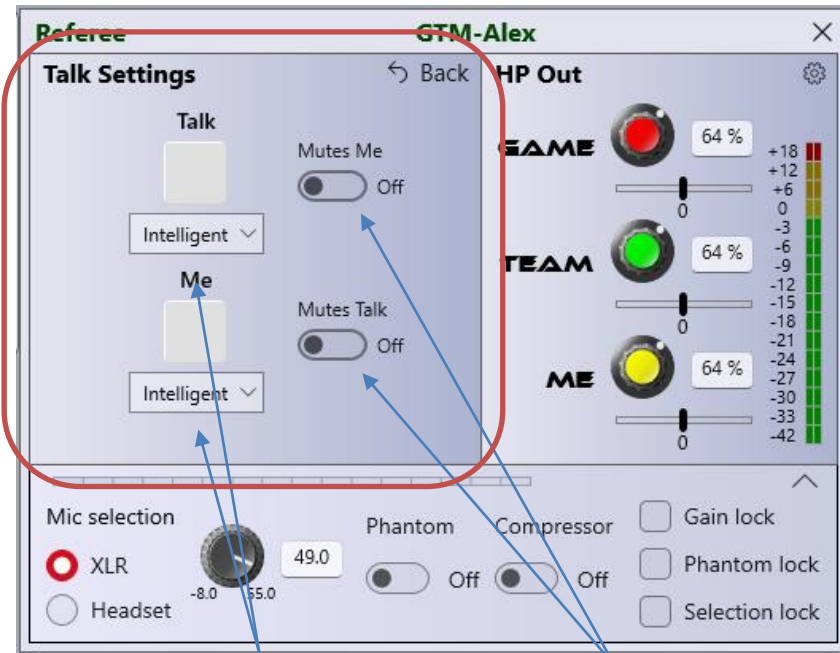

Button behaviour setting

Mute other speak button when active

Game Mix Settings

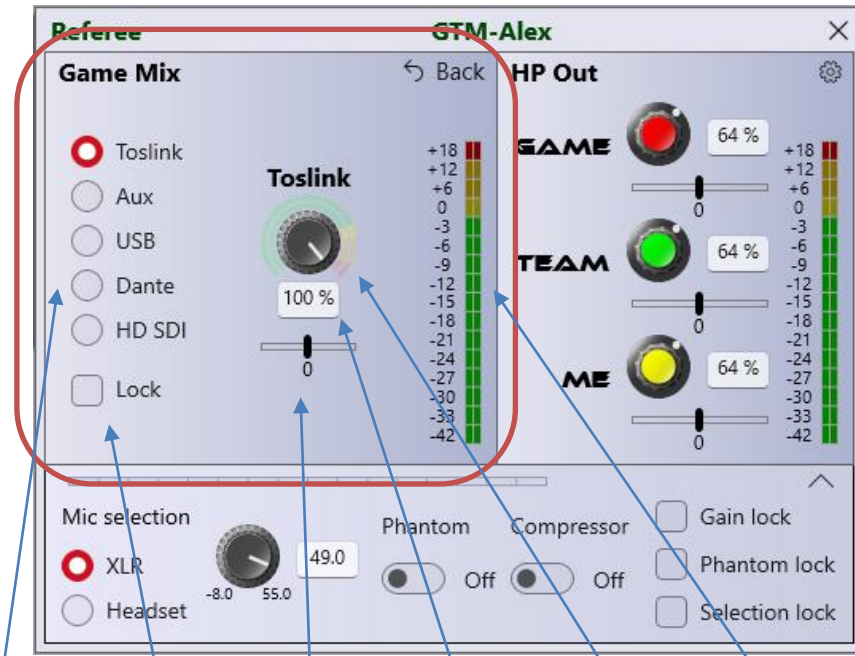

Game source selection

Disable source selection switch on the unit

Game source stereo panning

Game source volume control

Pre-pot game level metering

Post-pot game level metering

Team Mix Settings



Post-pots team mix level metering

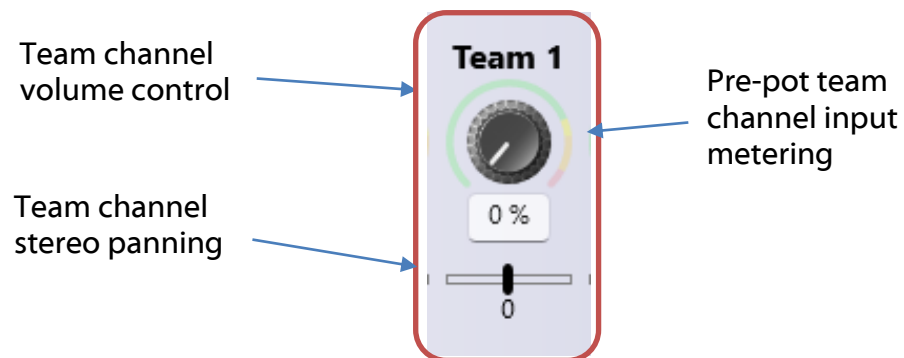

Go to <https://www.glen sound.co.uk/product-details/glencontroller/> and check the **'Useful Videos'** tab for informative YouTube tutorials on how to use other features of Glen sound Controller.

Saving and loading presets

Glensound controller allows saving and loading of 'Presets' which is a saved copy of the configured settings of the GTM.

Saving Preset

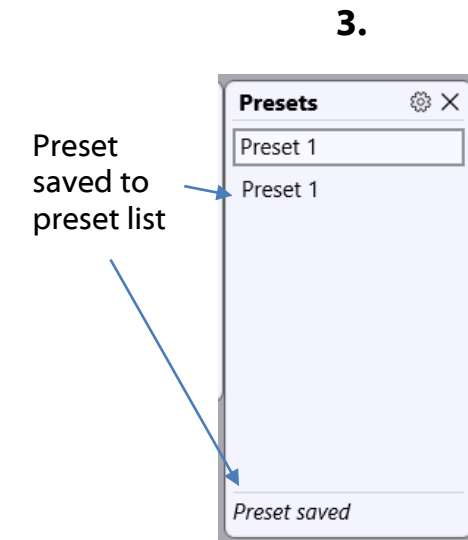
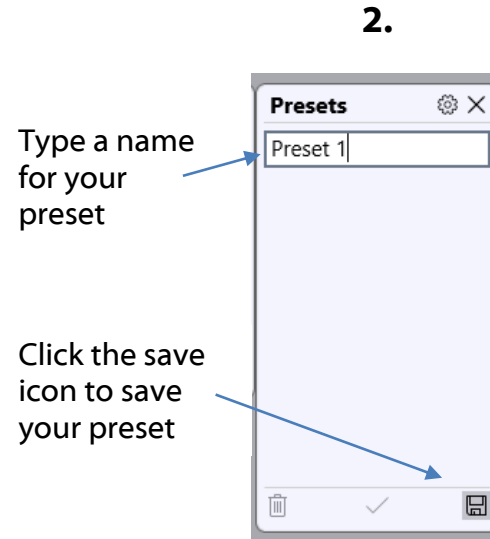
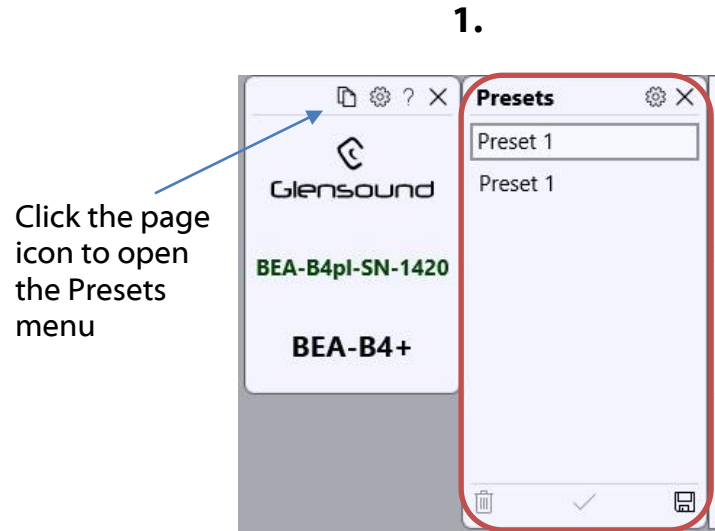

Loading Preset

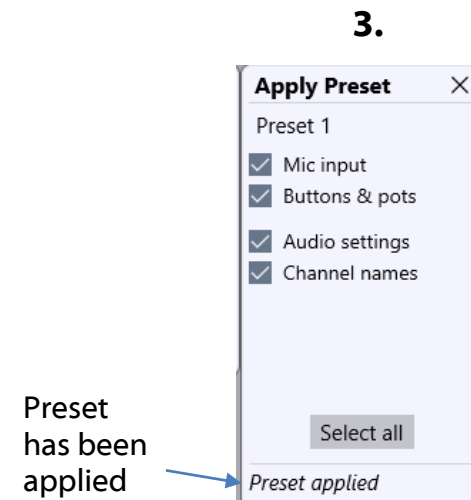
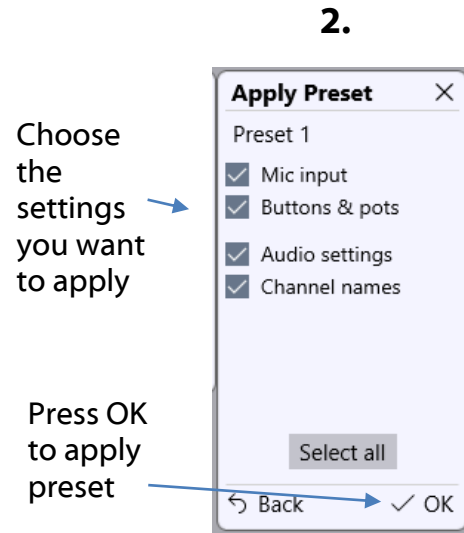
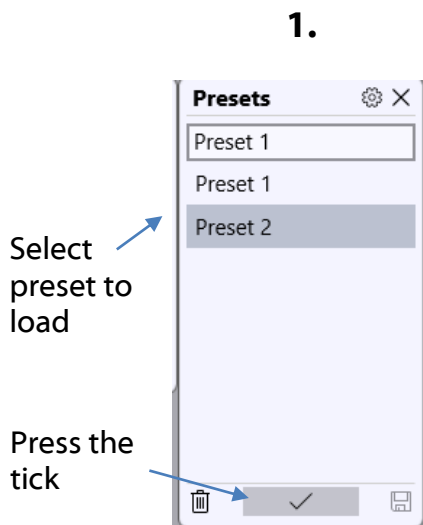

Updating Firmware

The GTM microcontroller code is the main firmware that operates the device. It can be updated via GlenController over an IP network. Make sure your PC is connected to the same network and can see the GTM in GlenController.

You may need internet access for GlenController to automatically obtain the latest code from the database.

If you require offline updating please contact office@glen sound.com and we can provide a manual offline method.

Instructions

1.

A. Click the sidebar icon to access the sidebar

B. Click the cog icon to open the settings page

C. Click to enter maintenance mode

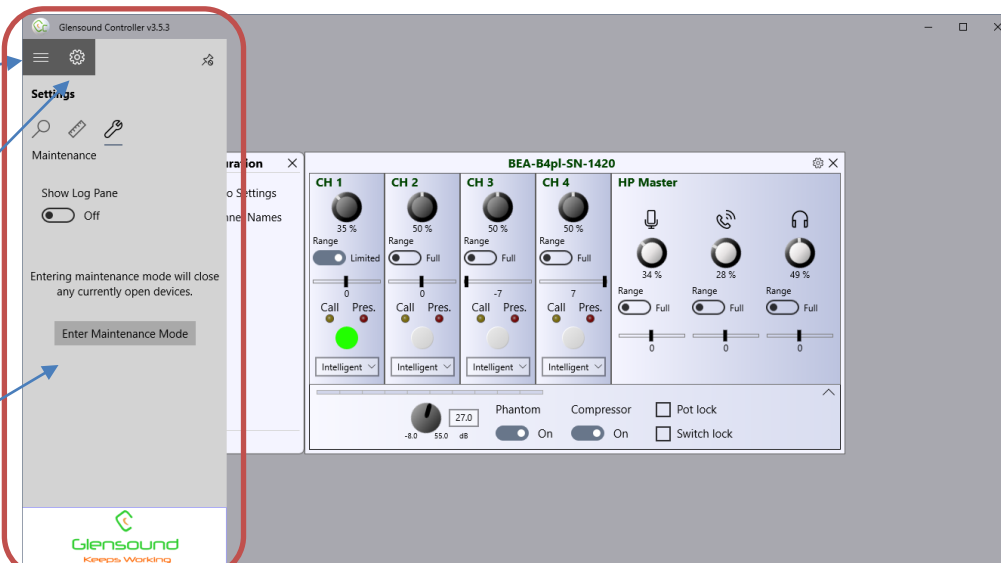
The screenshot shows the GlenController v3.5.3 application window. On the left, a sidebar is visible with a hamburger menu icon at the top. Below it are icons for Settings (a cog), Maintenance (a wrench), and Show Log Pane (a document). The Settings page is currently selected, showing a 'Show Log Pane' toggle set to 'Off' and an 'Enter Maintenance Mode' button. A red box highlights the sidebar area. Blue arrows point from the text instructions to the sidebar icon, the cog icon, and the 'Enter Maintenance Mode' button. In the background, a control panel for 'BEA-B4pl-SN-1420' is visible, showing four channels (CH 1, CH 2, CH 3, CH 4) and an HP Master section with various sliders and buttons.

2.

A. Select the device you wish to update

B. Click to update your device

The screenshot shows the 'Device Maintenance' screen in GlenController v3.5.3. At the top, there is a warning: 'WARNING: During update audio will be disrupted.' Below the warning is an 'Update Selected' button. A table lists the available devices for update. A blue arrow points to the first device in the table, and another blue arrow points to the 'Update Selected' button. The GlenController logo is at the bottom left.

Name	HostName	Type	IP 1	IP 2	DNT version	DFU version	DFU latest	
<input checked="" type="checkbox"/>	BEA-B4pl-SN-1420	BEA-B4pl-02002a	BEA-B4+	169.254.197.11	0.0.0.0	1.0.0	1.1.0	1.1.0

Caution! Audio will be interrupted during the device update

3.

Click start to begin updating



4.

Update progression bar

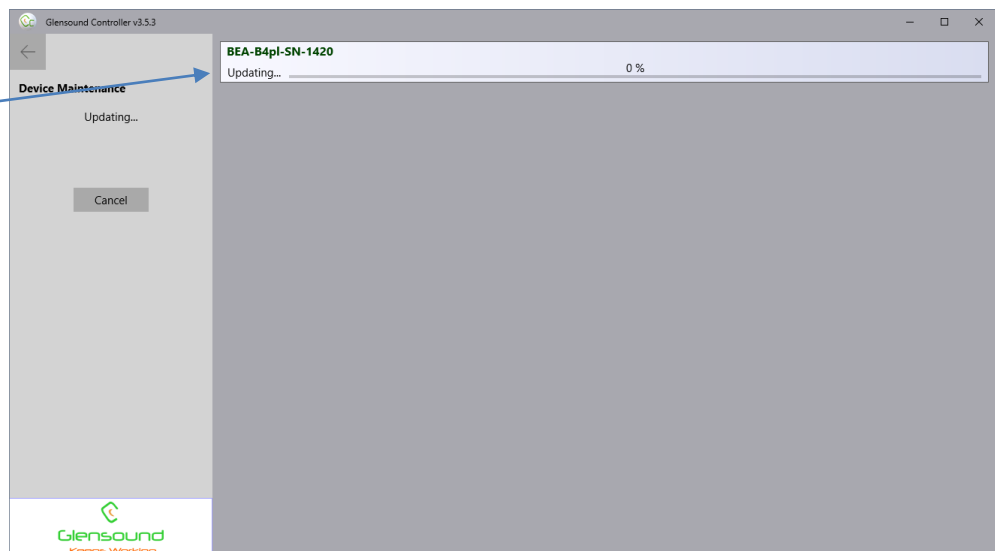

5.

Update finished, device will now restart automatically



Updating The Dante firmware

The GTM has Dante specific firmware that runs inside the Dante chipset, known as Broadway.

The Broadway Chipset is a device supplied by Audinate that does most of the processing for the actual Dante/ AES67 network audio streams. There is one Broadway Chipset in each GTM.

Updating the device

The firmware that runs in the Broadway Chipset can be updated using the built-in Dante Updater in Dante Controller. Please ensure you have a connection to the internet.

If you want to update devices on a Dante network that is not connected to the Internet, you can download the files ahead of time to your computer, move the computer to the offline network, and then update the devices using the downloaded files.

Dante Updater displays a list of all online firmware files in the Library tab, so you can choose which files to download, or even download the entire database if you are not sure which files you will need. For further details please visit www.audinate.com

1.

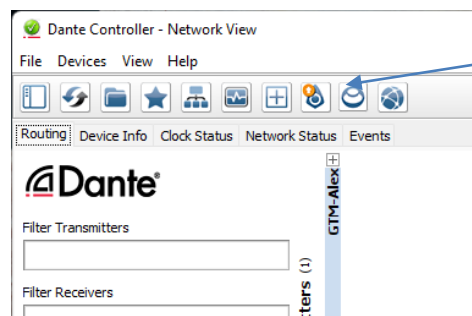

Dante controller notifies you if a device on your network is out of date.

Click the icon

2.

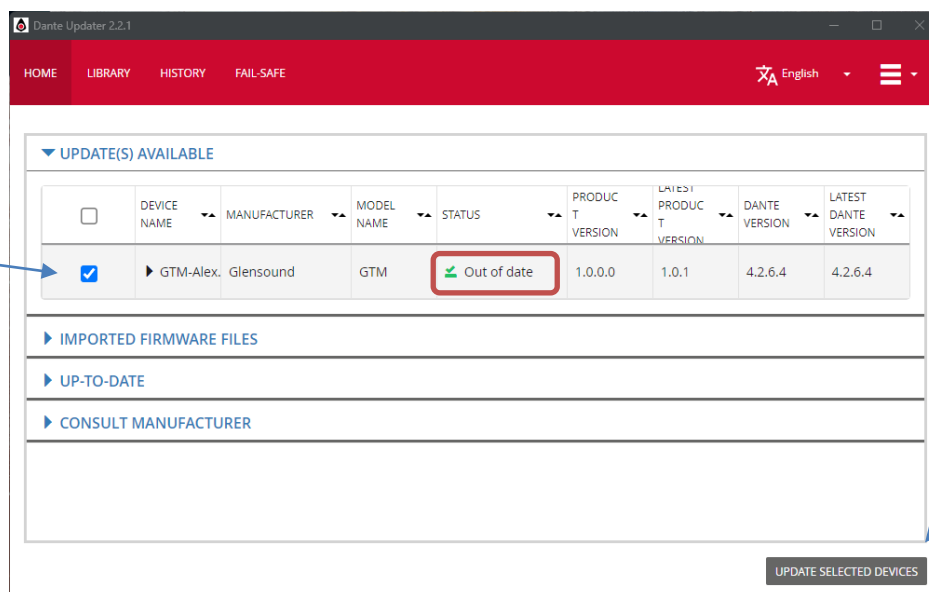

A. Tick the box to choose your unit for updating

B. Press to update device

3.

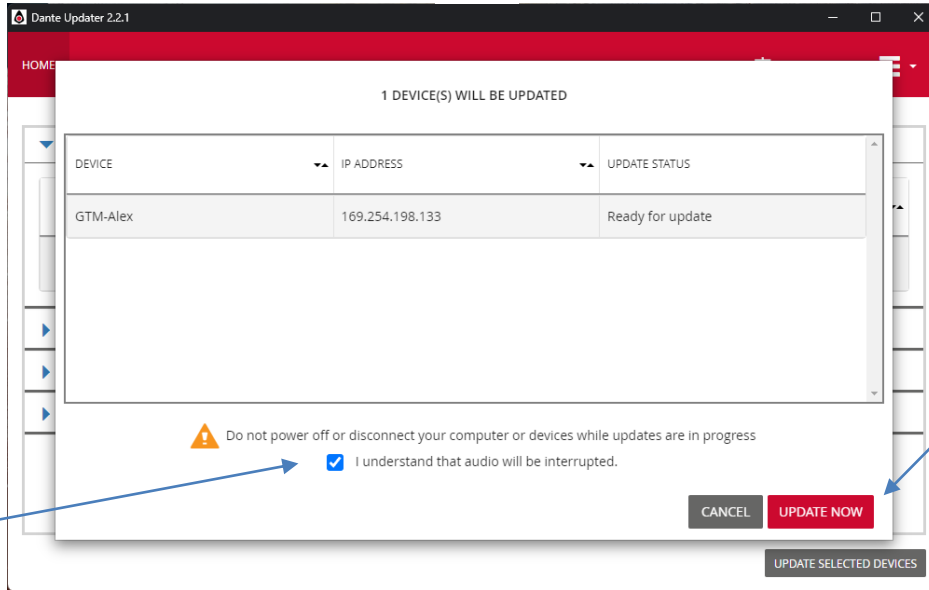

Caution! Audio will be interrupted during the device update

A. Tick box to confirm

B. Press to update device

4.

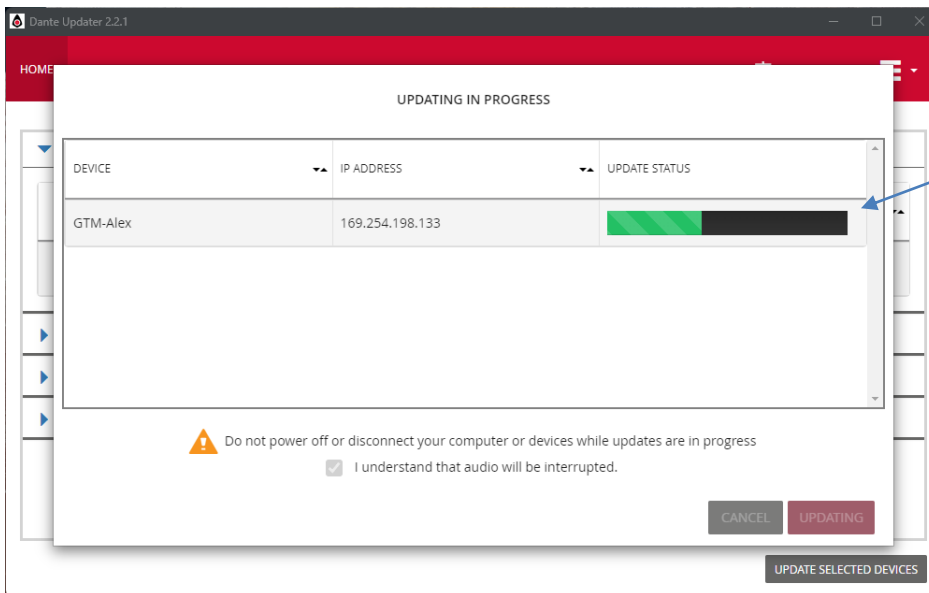

Update is in progress

5.

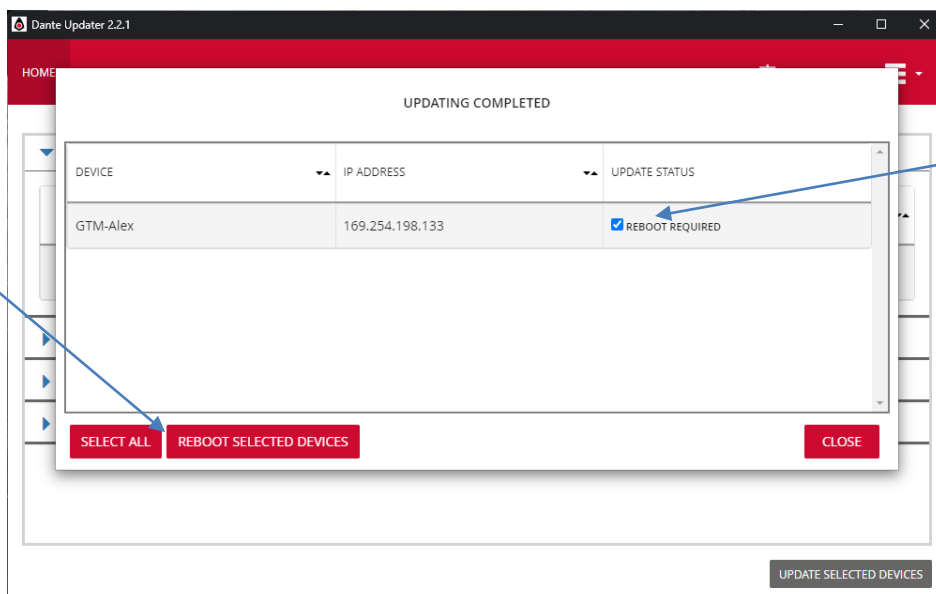

A. Update finished. Tick box to continue

B. Press to reboot device

Update finished, device will now reboot

GTM DC Loop I/O



Pin 1

- Input: parallel with Talk pushbutton

Pin 2

- Output: parallel with Talk button LED

Pin 3

- Input: parallel with Talk 2 pushbutton

Pin 4

- Output: parallel with Talk 2 button LED

Pin 5

- Input: white noise on/off: Low = noise OFF, High (or not connected) = noise ON

Pin 6

- GND

CONNECTING LOOP OUT TO A LOGIC INPUT

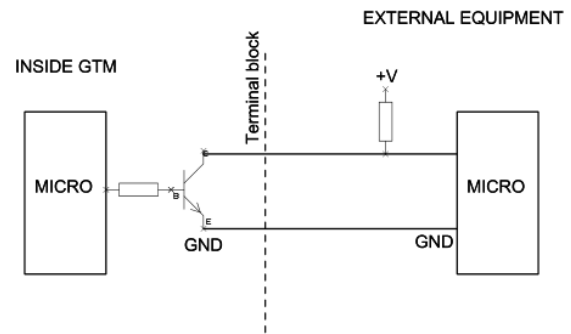

CONNECTING LOOP OUT TO A RELAY

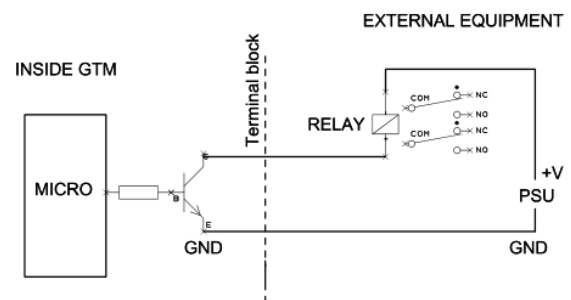

CONNECTING LOOP OUT TO AN OPTO ISOLATOR

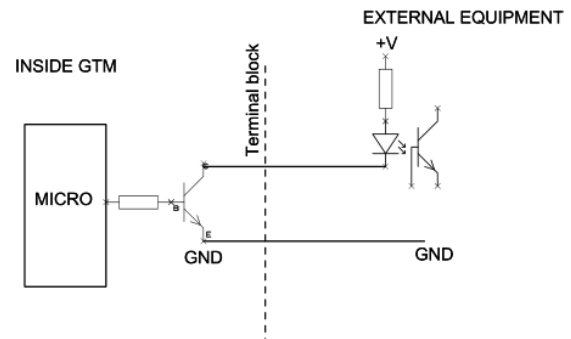

CONNECTING LOOP INPUT

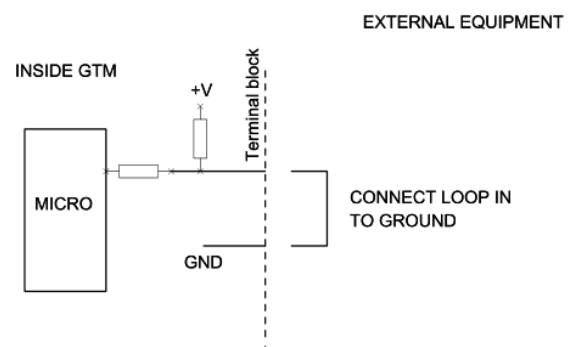

Wiring Information

XLR & Jack Wiring

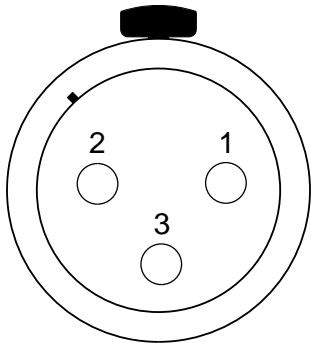

XLR SOCKET (FEMALE)

STANDARD XLR AUDIO PINOUTS:

- 1: Ground/ Earth**
- 2: INPHASE/ POSITIVE/ MIC +**
- 3: MATE/ NEGATIVE/ MIC -**



STANDARD HEADPHONE WIRING:

- TIP: A/ LEFT Ear**
- RING: B/ RIGHT Ear**
- SLEEVE: Ground / Earth**

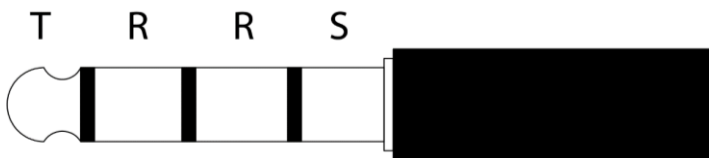

TRRS HEADSET WIRING

CTIA (GTM standard)

- T: A/ LEFT Ear**
- R: B/ RIGHT Ear**
- R: Ground / Earth**
- S: MIC +**

OMTP (Available on request)

- T: A/ LEFT Ear**
- R: B/ RIGHT Ear**
- R: MIC +**
- S: Ground / Earth**

Optional 5 Or 4 Pin XLR Wiring Information

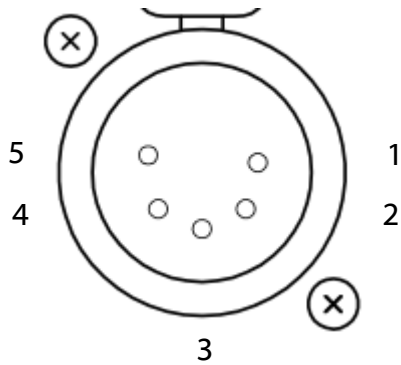

5 PIN XLR AUDIO PINOUTS:

Female XLR fitted to GTM, mates with cable mounted male

1: MATE/ NEGATIVE/ MIC -

2: INPHASE/ POSITIVE/ MIC +

3: GROUND/ EARTH

4: HEADPHONE LEFT

5: HEADPHONE RIGHT

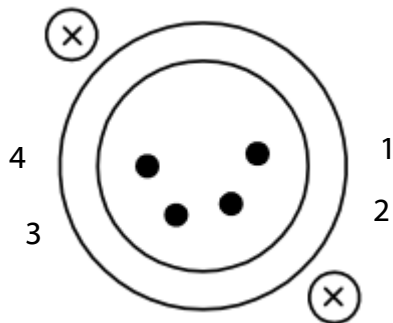

4 PIN XLR AUDIO PINOUTS:

Male XLR fitted to GTM, mates with cable mounted female

1: MIC GND/ MIC -

2: INPHASE/ POSITIVE/ MIC +

3: HEADPHONE GND

4: POSITIVE/ HEADPHONE +